

АНТЕННЫ И АКСЕССУАРЫ КАТАЛОГ

Архангельск (8182)63-90-72
Астана (7172)727-132
Астрахань (8512)99-46-04
Барнаул (3852)73-04-60
Белгород (4722)40-23-64
Брянск (4832)59-03-52
Владивосток (423)249-28-31
Волгоград (844)278-03-48
Вологда (8172)26-41-59
Воронеж (473)204-51-73
Екатеринбург (343)384-55-89
Иваново (4932)77-34-06

Ижевск (3412)26-03-58
Иркутск (395)279-98-46
Казань (843)206-01-48
Калининград (4012)72-03-81
Калуга (4842)92-23-67
Кемерово (3842)65-04-62
Киров (8332)68-02-04
Краснодар (861)203-40-90
Красноярск (391)204-63-61
Курск (4712)77-13-04
Липецк (4742)52-20-81

Киргизия (996)312-96-26-47

Магнитогорск (3519)55-03-13
Москва (495)268-04-70
Мурманск (8152)59-64-93
Набережные Челны (8552)20-53-41
Нижний Новгород (831)429-08-12
Новокузнецк (3843)20-46-81
Новосибирск (383)227-86-73
Омск (3812)21-46-40
Орел (4862)44-53-42
Оренбург (3532)37-68-04
Пенза (8412)22-31-16

Россия (495)268-04-70

Пермь (342)205-81-47
Ростов-на-Дону (863)308-18-15
Рязань (4912)46-61-64
Самара (846)206-03-16
Санкт-Петербург (812)309-46-40
Саратов (845)249-38-78
Севастополь (8692)22-31-93
Симферополь (3652)67-13-56
Смоленск (4812)29-41-54
Сочи (862)225-72-31
Ставрополь (8652)20-65-13

Казахстан (772)734-952-31

Сургут (3462)77-98-35
Тверь (4822)63-31-35
Томск (3822)98-41-53
Тула (4872)74-02-29
Тюмень (3452)66-21-18
Ульяновск (8422)24-23-59
Уфа (347)229-48-12
Хабаровск (4212)92-98-04
Челябинск (351)202-03-61
Череповец (8202)49-02-64
Ярославль (4852)69-52-93

CONTENT

Chapter	Contents	Page
	Icons	3
	Company Profile	4
	Services	
	Antenna calibration	10
	Formulas	11
	Antenna selection guide	19
1	HF Antennas	23
2	VHF/UHF Antennas	61
3	SHF Antennas	131
4	Accessories	175
	Glossary	200
	Index	210

ICONS

Icon	Description
	Antenna for mobile or semi-mobile applications
	Antenna for stationary applications
	Antenna for naval applications
	Antenna for indoor applications, e.g. in test chambers
	Receiving antenna
	Transmitting antenna
	Active antenna or antenna with preamplifier
	Antenna with directional radiation pattern
	Antenna with omnidirectional radiation pattern
	Device can be operated with DC power supply
	Device can be operated with AC power supply
	Linearly/horizontally polarized antenna (using recommended mounting position)
	Linearly/vertically polarized antenna (using recommended mounting position)
	Crossed antenna for linear and orthogonal linear polarization
	Left-hand circularly polarized antenna
	Right-hand circularly polarized antenna
	Antenna suitable as feed for reflector antenna systems
	Device can be remote controlled
	Antenna for air traffic control (ATC) applications
	High gain antenna, e.g. for electromagnetic susceptibility (EMS) applications
	Calibrated antenna (calibration certificate supplied with device)

TEST AND MEASUREMENT

Test and measurement solutions for the wireless market, automotive applications, aerospace and defense, industrial electronics, research and education

No industrial sector can do without electronics. Test and measurement solutions from Rohde & Schwarz are there every step of the way, from R&D to quality assurance to manufacturing and service. Our portfolio includes all types of RF T&M equipment and systems as well as complementary products.

We focus on the requirements of the mobile and wireless communications market, a market we have been closely involved with for decades, on the requirements of the automotive industry, whose added value is increasingly based on vehicles' electronic features, and on the T&M requirements of the aerospace and defense industry. Manufacturers of entertainment electronics, power electronics, RF components, IT and network equipment as well as medical technology companies and other sectors also benefit from our wide range of products.

Research and education also require an extensive portfolio of T&M equipment in various performance classes. From basic testers for training to submillimeterwave analyzers and high-power RF amplifiers for particle accelerators, the Rohde & Schwarz portfolio meets all of these requirements.

Our portfolio

- ▶ Wireless market
 - Basic RF T&M instruments such as signal generators and analyzers with standard-specific T&M options
 - Wireless device RF and protocol testers for all common cellular and non-cellular wireless communications standards
 - Conformance and preformance test systems
 - Products for measuring quality in mobile networks
 - System equipment, e.g. shielded chambers
 - ITU-compliant radiomonitoring solutions for regulators
- ▶ Automotive industry
 - T&M equipment for infotainment and wireless connectivity components such as V2X, 5G, eCall, GNSS and Bluetooth®
 - Solutions for testing radar chips and sensors in R&D and production
 - Conformance T&M equipment for bus systems such as Ethernet and CAN
 - EMC T&M equipment
- ▶ Aerospace and defense
 - Wide range of RF and microwave T&M instruments for lab and field measurements
 - Catalog systems and customer-specific solutions
 - Test and measurement solutions for radar, avionics, navigation, satellite communications and military radiocommunications
 - Full range of EMC measuring equipment
 - Millimeterwave and submillimeterwave components

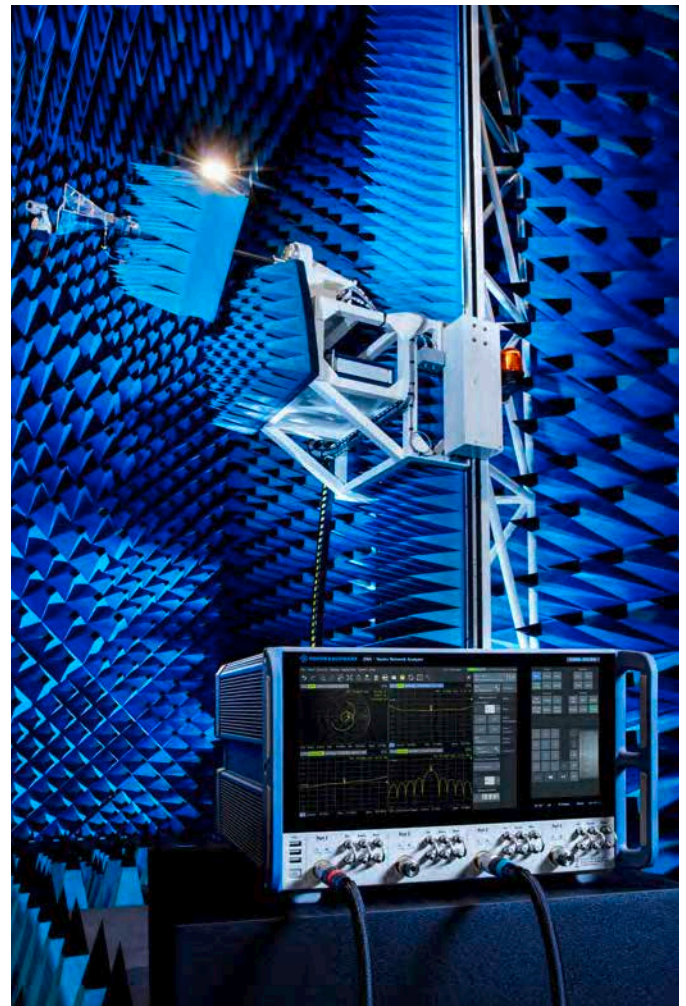

BROADCAST AND MEDIA

Solutions for the production, processing, broadcasting, measurement and quality control of audiovisual signals

Like many industries, broadcast and media has to keep pace with ongoing digitalization and the shift towards internet based solutions. Rohde&Schwarz, an innovator in the field of broadcasting for more than 70 years, supports this transformation with groundbreaking solutions. Today, the entire signal processing chain, from camera output to transmission via the various broadcast channels, can be realized with Rohde&Schwarz products. The Rohde&Schwarz portfolio includes T&M equipment for developing, manufacturing and ensuring the quality of consumer electronics devices and infrastructure components as well as monitoring products for broadcast networks.

Our portfolio

- ▶ TV and radio transmitters in all power classes and for all common worldwide standards
- ▶ Hardware and software for professional film and video post production and playout
- ▶ Broadcast and video T&M and monitoring solutions



NETWORKS AND CYBERSECURITY

Networks and cybersecurity solutions for business and government authorities

High-performance data networks and IT components are the backbone of business and society. The volume of dormant and transmitted data is growing exponentially, driven by the digitalization of all business processes, the increasing outsourcing of IT services to the cloud and the emerging internet of things.

Highly interconnected networks attract unwanted attention. According to the estimates of reliable organizations, cyber-attacks (especially theft of intellectual property) cost the global economy hundreds of billions of dollars each year. But intangible assets are not the only assets that need protection. The large quantities of sensitive public sector data as well as personal data generated by the financial sector, the health care system and online commerce also need to be protected. Manufacturers of network components and IT security technology have to provide secure, high-performance solutions for the transmission and storage of this data.

The Rohde&Schwarz subsidiaries Rohde&Schwarz Cybersecurity and LANCOM Systems offer a wide range of infrastructure components for WAN, SD-WAN, LAN and WLAN connectivity as well as cybersecurity solutions.

Our portfolio

- ▶ All components for secure WAN, SD-WAN, LAN and WLAN connectivity
- ▶ Network security products, e.g. firewalls
- ▶ Products to protect web and cloud applications
- ▶ Products to protect desktop applications
- ▶ Secure products for mobile communications
- ▶ Tools for network traffic and use analysis



AEROSPACE | DEFENSE | SECURITY

Security products for critical infrastructures

In times when crises and conflicts regularly make the headlines, critical infrastructures and public areas need more protection than ever. Rohde&Schwarz addresses this need with various products and solutions. Air traffic controllers in 80 countries and more than 200 airports and traffic management centers use our radio systems to ensure smooth air traffic. Rohde&Schwarz security scanners also provide protection by ensuring efficient security checks at airports and other high-security locations. Drones are opening up new possibilities in logistics, aerial photography and recreation. However, they can also easily be used for illegal purposes, such as for industrial espionage or to disrupt flight operations. The Rohde&Schwarz drone detection system reliably detects these unwanted intruders so that countermeasures can be taken.

And our IT security products protect IT infrastructures such as the signal lines in railway networks and control systems in supply engineering against tampering and tapping.

Secure radiocommunications systems

Today's military missions are typically combined missions in a multinational environment. The key to success is achieving information superiority through network centric operations. Rohde&Schwarz supplies interoperable radiocommunications systems for deployment on land, at sea and in the air. These systems are designed for simultaneous data and voice transmission, consistently high voice quality and low latency. Rohde&Schwarz uses recognized standards to securely, economically, flexibly and sustainably network our customers' platforms.

The company's broad radio portfolio includes portable radios, radios for stationary applications and systems for use in vehicles, ships, airplanes and helicopters. The employed encryption methods meet the most exacting domestic and international security requirements and safeguard the digital sovereignty of our government customers.

Reconnaissance

Reliable situational information is essential for making decisions in crisis situations and during military missions. Communications intelligence (COMINT) is a key factor. As a passive instrument, it can deploy its capabilities unobserved and far from the area of interest. This can actually help de-escalate conflicts since objectives can be achieved without violating sovereignty. Rohde&Schwarz has served this segment for decades. The company offers an extensive range of sensors (antennas, receivers, direction find-



ers), signal processing and analysis systems and software for all frequency ranges from HF to SHF (satcom) and for deployment on land, at sea and in the air.

Our radar intelligence (ELINT) systems detect state-of-the-art LPI radars, effectively increasing the safety of deployed forces.

Our portfolio

- ▶ Security products for critical infrastructures
 - Radio systems for air traffic control
 - Security scanners
 - Radiomonitoring and direction finding systems, also specifically for drones
 - IT security solutions
- ▶ Secure radiocommunications systems
 - Integrated modular communications systems for military ATC as well as for the army, navy and air force
 - Encryption technology for all classification levels
- ▶ Secure radiocommunications systems
 - Communications intelligence systems
 - Radar intelligence systems
 - Satellite monitoring systems
 - Signal and IP analysis systems

SERVICE

Rohde & Schwarz stands for innovative service products throughout the entire product lifecycle, supported by a global service network.

The following services are available in over 70 countries:

- ▶ Calibration
- ▶ Maintenance and repair
- ▶ Product updates and upgrades
- ▶ Remote service

Rohde & Schwarz regional service centers, plants and specialized subsidiaries provide a wide range of additional services for system customers:

- ▶ System integration
- ▶ Application support
- ▶ Development of customized modules, equipment and systems
- ▶ Software development
- ▶ Installation and commissioning
- ▶ Application support

During the product's useful life, Rohde & Schwarz supports its customers with service level agreements in the following areas:

- ▶ System support
- ▶ Training
- ▶ Maintenance
- ▶ Spare parts service
- ▶ Integrated logistics support
- ▶ Obsolescence management
- ▶ Technical documentation



Repair service



Calibration lab

SERVICES

ANTENNA CALIBRATION

As a DAkkS (formerly DKD) accredited lab, we not only calibrate newly manufactured Rohde&Schwarz antennas, we can also calibrate customers' antennas if required.

Measurands

The following quantities can be calibrated:

- ▶ Antenna factor
- ▶ Gain
- ▶ VSWR
- ▶ Balance/symmetry

Calibration of the following antenna types

- ▶ Biconical antennas
- ▶ Log-periodic antennas
- ▶ Hybrid antennas (biconical log-periodic antennas)
- ▶ Horn antennas
- ▶ Monopole antennas
- ▶ Loop antennas

Calibration sites

- ▶ Reference open area test site (20 MHz to 18 GHz)
- ▶ Fully anechoic chamber (200 MHz to 18 GHz)

Standards

- ▶ ANSI C63.5
- ▶ CISPR 16-1-6
- ▶ SAE ARP958

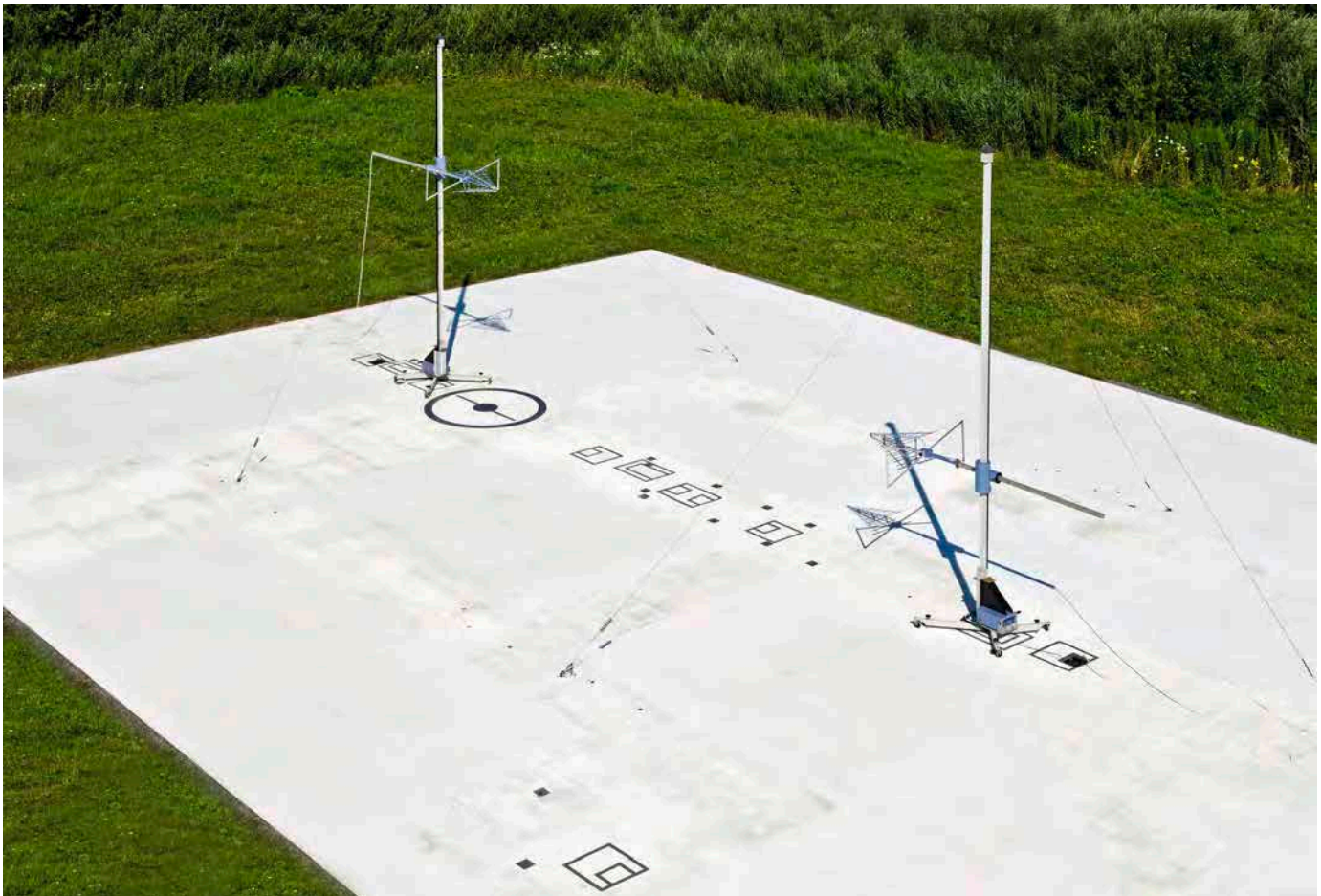

FORMULAS

General	
Prefix	Value
T (Tera)	10^{12}
G (Giga)	10^9
M (Mega)	10^6
k (kilo)	10^3
h (hecto)	10^2
da (deca)	10^1
d (deci)	10^{-1}
c (centi)	10^{-2}
m (milli)	10^{-3}
μ (micro)	10^{-6}
n (nano)	10^{-9}
p (pico)	10^{-12}
f (femto)	10^{-15}
a (atto)	10^{-18}

ITU frequency bands				
Range	f	λ	Classification	Principal use
VLF	3 kHz to 30 kHz	100 km to 10 km	Very low frequency	Submarines
LF	30 kHz to 300 kHz	10 km to 1 km	Low frequency	Beacons
MF	300 kHz to 3 MHz	1000 m to 100 m	Medium frequency	AM broadcasting
HF	3 MHz to 30 MHz	100 m to 10 m	High frequency	Shortwave communications
VHF	30 MHz to 300 MHz	10 m to 1 m	Very high frequency	FM, TV, ATC
UHF	300 MHz to 3 GHz	1 m to 0.1 m	Ultra high frequency	TV, LAN, cellular services, GPS, ATC
SHF	3 GHz to 30 GHz	10 cm to 1 cm	Super high frequency	Radar, GSO satellites, data transmission
EHF	30 GHz to 300 GHz	10 mm to 1 mm	Extremely high frequency	Radar, automotive applications

Frequency notations		
Frequency	Common usage bands	Electronic countermeasures bands
0.5 GHz to 1.0 GHz	-	C
1.0 GHz to 2.0 GHz	L	D
2.0 GHz to 3.0 GHz	S	E
3.0 GHz to 4.0 GHz	S	F
4.0 GHz to 6.0 GHz	C	G
6.0 GHz to 8.0 GHz	C	H
8.0 GHz to 10.0 GHz	X	I
10.0 GHz to 12.5 GHz	X	J
12.5 GHz to 18.0 GHz	Ku	J
18.0 GHz to 20.0 GHz	K	J
20.0 GHz to 26.5 GHz	K	K
26.5 GHz to 40.0 GHz	Ka	K
40.0 GHz to 60.0 GHz	Q, V	L
60.0 GHz to 100.0 GHz	W	M

Measures of length

Distance	Equivalent to
1 meter (m)	= 10 decimeters (dm) = 100 centimeters (cm) = 1000 millimeters (mm) = 1 000 000 micrometers (µm)
1 kilometer (km)	= 1000 m
1 sea mile	= 10 cable lengths = 1852 m
1 English statute mile	= 1760 yards = ~ 1609 m
1 yard	= 3 feet = 36 inches = 91.44 cm
1 inch (in)	= 25.4 mm (accurately 25.399956 mm)

Inch to mm

Inch	mm
1/64	0.397
1/32	0.794
1/16	1.587
1/8	3.175
3/16	4.762
1/4	6.350
3/8	9.525
1/2	12.700
5/8	15.875
3/4	19.050
7/8	22.225
1	25.400

Conversion

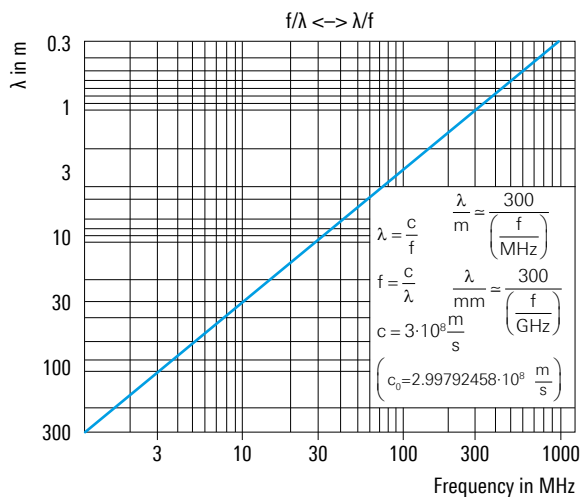

Smith diagram

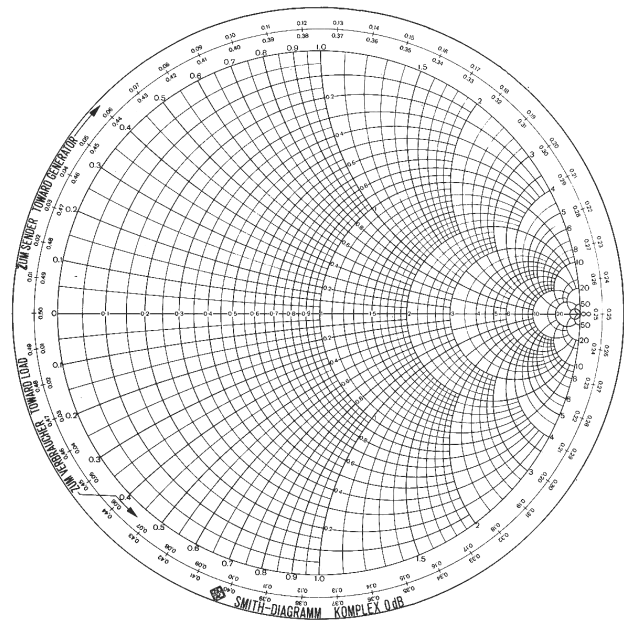

Reflection, matching

s	VSWR	r	Reflection coefficient	$\frac{V \leftarrow}{V \rightarrow}$	P_{refl} in %	a_R in dB	$20 \lg \left(\frac{V \leftarrow}{V \rightarrow} \right)$
a_R	Return loss	s	(VSWR)	r			
			$\frac{V_{\text{max}}}{V_{\text{min}}}$				

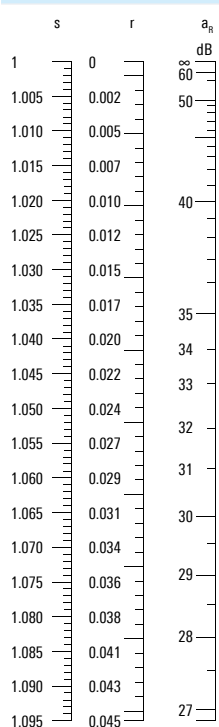

1.01	0.005		46.1
1.02	0.010	0.01	40.1
1.03	0.015	0.02	36.6
1.04	0.020	0.04	34.2
1.05	0.024	0.06	32.3
1.06	0.029	0.08	30.7
1.07	0.034	0.11	29.4
1.08	0.038	0.15	28.3
1.09	0.043	0.19	27.3
1.10	0.048	0.23	26.4
1.11	0.052	0.27	25.6
1.12	0.057	0.32	24.9
1.13	0.061	0.37	24.3
1.14	0.065	0.43	23.7
1.15	0.070	0.49	23.1
1.16	0.074	0.55	22.6
1.17	0.078	0.61	22.1
1.18	0.083	0.68	21.7
1.19	0.087	0.75	21.2
1.20	0.091	0.83	20.8
1.30	0.130	1.70	17.7
1.40	0.167	2.78	15.6
1.50	0.200	4.00	14.0
1.60	0.231	5.33	12.7
1.70	0.259	6.72	11.7
1.80	0.286	8.16	10.9
1.90	0.310	9.63	10.2
2.00	0.333	11.10	9.5
2.20	0.375	14.1	8.5
2.40	0.412	17.0	7.7
2.60	0.444	19.8	7.0
2.80	0.474	22.4	6.5
3.00	0.500	25.0	6.0
3.50	0.556	30.9	5.1
4.00	0.600	36.0	4.4
5.00	0.667	44.4	3.5
6.00	0.714	51.0	2.9
7.00	0.750	56.2	2.5
8.00	0.778	60.5	2.2
10.0	0.818	66.9	1.7
20.0	0.905	81.9	0.9
50.0	0.961	92.3	0.3

$$s = \frac{1+|r|}{1-|r|}$$

$$s = \frac{10^{0.05 a_R + 1}}{10^{0.05 a_R - 1}}$$

$$r = \frac{s-1}{s+1}$$

$$r = \frac{1}{10^{0.05 a_R}}$$

$$a_R = 20 \lg \left(\frac{s+1}{s-1} \right)$$

$$a_R = 20 \lg \left(\frac{1}{|r|} \right)$$

Formulas

VSWR and return loss

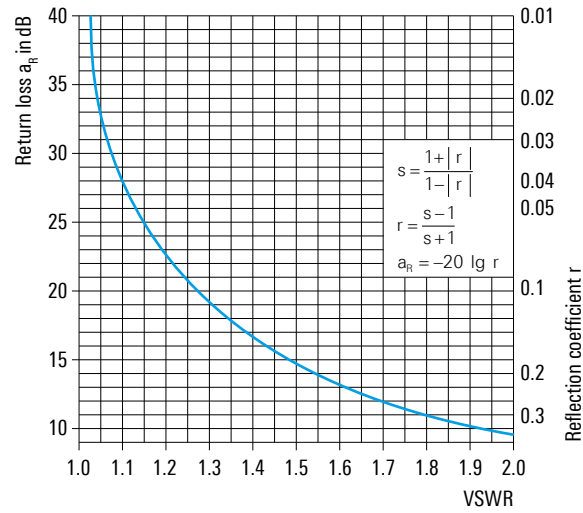
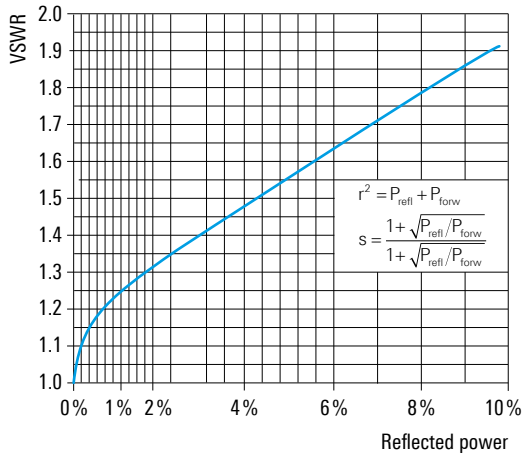

Voltage and power ratio

Levels ¹⁾			
Type of level	Definition	Unit	Abbreviation
Absolute power level	$10 \lg \frac{P}{1 \text{ mW}}$	dB(mW)	dBm
	$10 \lg \frac{P}{1 \text{ W}}$	dB(W)	dBW
Absolute voltage level	$20 \lg \frac{V}{1 \mu\text{V}}$	dB(μV)	dB μV
	$20 \lg \frac{V}{1 \text{ V}}$	dB(V)	dBV
Power density level referred to frequency	$10 \lg \frac{P/W}{\Delta f/\text{Hz}}$	dB(W/Hz)	–
Power density level referred to antenna surface	$10 \lg \frac{P/W}{A/\text{m}^2}$	dB(W/m ²)	–
Field strength level	$20 \lg \frac{E}{1 \mu\text{V/m}}$	dB($\mu\text{V/m}$)	–
Relative level	$10 \lg \frac{P}{P_0}$ ¹⁾	–	dBr

¹⁾ P_0 = base power level.

Power, voltage

Level

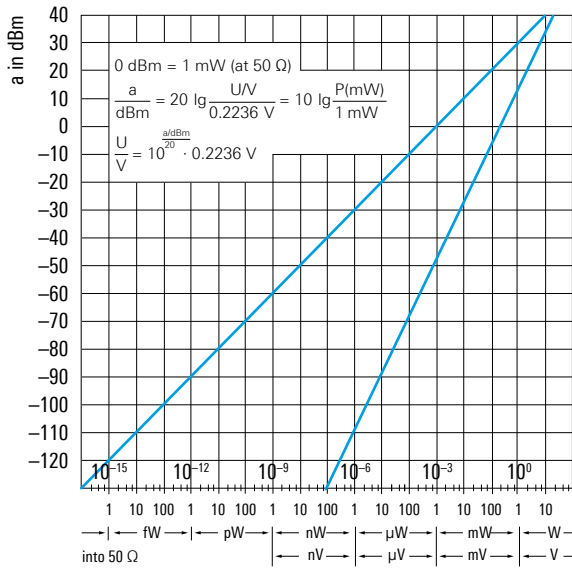

Spherical coordinates

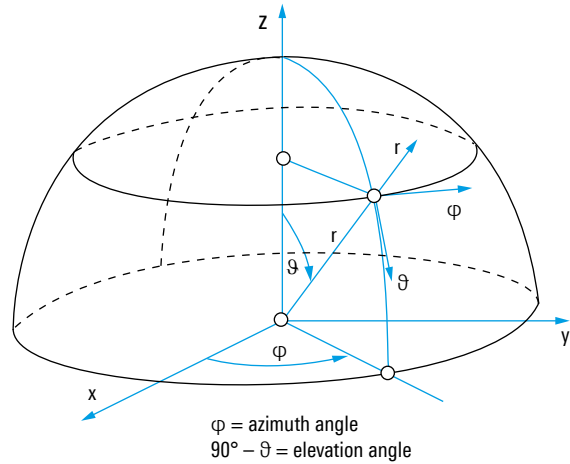

Inductance, capacitance

Cylindrical coil

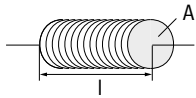

$$L \approx \mu_0 \cdot V_1 \cdot N^2 \frac{A}{l}$$

$$\mu_0 = 4\pi \cdot 10^{-7} \frac{\text{Vs}}{\text{Am}}$$



$$L_{\text{total}} = L_1 + L_2$$

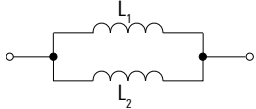

$$L_{\text{total}} = \left(\frac{1}{L_1} + \frac{1}{L_2} \right)^{-1}$$

Plate capacitor

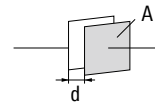

$$C \approx \epsilon_0 \cdot \epsilon_r \frac{A}{d}$$

$$\epsilon_0 \approx 8.8541 \cdot 10^{-12} \frac{\text{F}}{\text{m}}$$

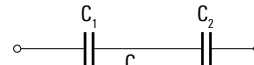

$$C_{\text{total}} = \left(\frac{1}{C_1} + \frac{1}{C_2} \right)^{-1}$$

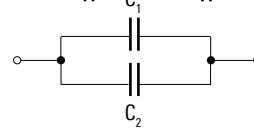

$$C_{\text{total}} = C_1 + C_2$$

Frequency of a resonant circuit

$$f_0 = \frac{1}{2 \cdot \pi \cdot \sqrt{L \cdot C}}$$

f_0 = resonant frequency

L = inductance

C = capacitance

Correlation of E field and H field based on intrinsic impedance of free space

$$E = Z_0 \cdot H \quad \text{or} \quad H = \frac{E}{Z_0}$$

E = incident electric field strength

H = incident magnetic field strength

Intrinsic impedance of free space

$$Z_0 = \sqrt{\frac{\mu_0}{\epsilon_0}} \sim 120 \cdot \pi \Omega \approx 377 \Omega$$

Z_0 = intrinsic impedance of free space in Ω

μ_0 = permeability of vacuum

ϵ_0 = permittivity of vacuum

Coaxial line impedance

$$Z_L \approx 60 \Omega \cdot \frac{1}{\sqrt{\epsilon_r}} \ln \left(\frac{D}{d} \right)$$

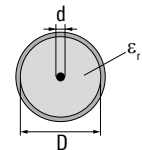

Z_L = line impedance

ϵ_r = relative permittivity (dimensionless)

D = outer diameter in m (see drawing)

d = inner diameter in m (see drawing)

Formulas

Symmetrical line impedance

$$Z_L \approx 120 \Omega \cdot \frac{1}{\sqrt{\epsilon_r}} \ln \left(\frac{2D}{d} \right) \quad (\text{valid for: } d \ll D)$$

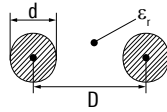

Z_L = line impedance

ϵ_r = relative permittivity (dimensionless)

D = spacing between the two lines in m (see drawing)

d = diameter of each line in m (see drawing)

Directivity

$$D = \frac{P_{\max}}{P_{\text{av}}} \quad \text{and} \quad d = 10 \lg D$$

D = directivity of antenna (without any losses, linear, dimensionless)

P_{\max} = maximum radiated power density in boresight direction of antenna

P_{av} = average radiated power density of a spherical isotropic radiator

d = logarithmic directivity value of antenna in dB

Gain (including ohmic losses)

$$G = \frac{P_{\max}}{P_{\text{av0}}} \quad \text{and} \quad g = 10 \lg G$$

G = gain of antenna (linear, dimensionless)

P_{\max} = maximum radiated power density in boresight direction of antenna

P_{av0} = average radiated power density of a spherical isotropic radiator with an input power equal to that of the antenna of interest

g = logarithmic gain value of antenna in dB

Radiation efficiency

$$\eta = \frac{G}{D} \quad \text{or} \quad G = \eta \cdot D$$

η = radiation efficiency of antenna (dimensionless)

G = gain of antenna (including ohmic losses, dimensionless)

D = directivity of antenna (without any losses, dimensionless)

Realized gain

(including ohmic losses and mismatch losses)

$$G_p = G \cdot (1 - |r|^2)$$

G_p = realized gain of antenna (including ohmic losses and mismatch losses, dimensionless)

G = gain of antenna (including ohmic losses, dimensionless)

r = reflection coefficient (dimensionless)

Gain of active antennas

$$G_p = D \cdot G_e \quad \text{and} \quad g_p = 10 \lg G_p$$

G_p = realized gain of active antenna (dimensionless)

D = directivity of passive antenna part (without any losses, dimensionless)

G_e = gain of electronic circuit of antenna (dimensionless)

g_p = logarithmic gain of active antenna

Effective aperture

$$A_e = G \cdot \frac{\lambda^2}{4\pi} \quad \text{or} \quad G = A_e \cdot \frac{4\pi}{\lambda^2}$$

A_e = effective aperture of antenna

G = gain of antenna including ohmic losses (dimensionless)

λ = wavelength of electromagnetic wave

Aperture efficiency²⁾

$$\epsilon_{\text{ap}} = \frac{A_e}{A_p}$$

ϵ_{ap} = aperture efficiency (dimensionless)

A_e = effective aperture of antenna

A_p = physical (geometrical) aperture of antenna

Effective antenna length³⁾

$$h_e = \frac{V}{E} \quad \text{or} \quad V = E \cdot h_e \quad \text{and} \quad V = E \cdot \cos\theta \cdot \frac{\lambda}{\pi} \cdot \sqrt{\frac{R_r \cdot G}{Z_0}}$$

$$h_e = 2 \cdot \sqrt{\frac{R_r \cdot A_e}{Z_0}} \quad \text{or} \quad A_e = \frac{h_e^2 \cdot Z_0}{4 \cdot R_r}$$

h_e = effective antenna length

V = induced voltage

E = incident electric field strength

θ = angle between polarization angles of antenna and wave

λ = wavelength of electromagnetic wave

R_r = radiation resistance of antenna

G = gain of antenna including ohmic losses (linear, dimensionless)

Z_0 = intrinsic impedance of free space

A_e = effective aperture of antenna

Antenna factor

(only valid for a 50 Ω matched system)

$$K = \frac{E}{V} \quad \text{and} \quad K = \frac{2}{h_e}$$

K = antenna factor (linear)

E = incident electric field strength

V = induced voltage at a 50 Ω matched measurement device

h_e = effective antenna length

$$K = \frac{9.73}{\lambda \cdot \sqrt{G_p}}$$

λ = wavelength of electromagnetic wave

G_p = realized gain of antenna (including ohmic and mismatch losses, dimensionless)

$k = 20 \lg K$

k = logarithmic value of antenna factor

²⁾ Significant for aperture antennas only (e.g. horns, reflectors).

³⁾ Significant for electrical short and simple antennas only (e.g. a rod for low frequencies).

Free-space field strength (far field)

$$E_0 = \frac{\sqrt{30 \Omega \cdot P_t \cdot G_t}}{r}$$

E_0 = free-space field strength (far field)

P_t = transmitted power

G_t = gain of transmitting antenna including ohmic losses (linear, dimensionless)

r = distance from transmitting antenna

Friis transmission formula ⁴⁾

$$\frac{P_r}{P_t} = \frac{A_{er} \cdot A_{et}}{r^2 \cdot \lambda^2} = \frac{G_t \cdot G_r}{(4\pi r/\lambda)^2}$$

P_r = received power

P_t = transmitted power

A_{er} = effective aperture of receiving antenna

A_{et} = effective aperture of transmitting antenna

G_t = gain of transmitting antenna (linear, dimensionless)

G_r = gain of receiving antenna (linear, dimensionless)

λ = wavelength

r = distance between antennas

Maximum received power ⁴⁾

$$P_r = P_t \cdot G_t \cdot G_r \cdot \left(\frac{\lambda}{4\pi r}\right)^2$$

P_r = received power

P_t = transmitted power

G_t = gain of transmitting antenna (linear, dimensionless)







G_r = gain of receiving antenna (linear, dimensionless)

λ = wavelength

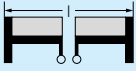
r = distance between antennas

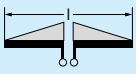
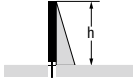
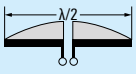
⁴⁾ Precondition: optimum alignment of both antennas with regard to polarization and boresight direction.

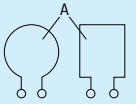
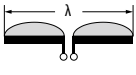
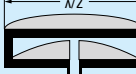
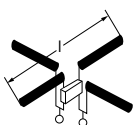
Formulas

Parameters of selected antenna types						
Type of antenna	Current distribution	Directivity factor D ⁵⁾	Effective antenna length	Radiation resistance R in Ω	Field strength in direction of maximum radiation ⁶⁾ in mV/m	
Isotropic radiator		1 ± 0 dB			$\sqrt{30} \cdot \frac{\sqrt{P/W}}{r/\text{km}}$	$173 \cdot \frac{\sqrt{P/kW}}{r/\text{km}}$
Hertz dipole with end capacitance ⁷⁾		1.5 ± 1.8 dB	l	$80 \pi^2 \left(\frac{l}{\lambda}\right)^2$	$3 \cdot \sqrt{5} \cdot \frac{\sqrt{P/W}}{r/\text{km}}$	$212 \cdot \frac{\sqrt{P/kW}}{r/\text{km}}$
Short antenna on infinitely conducting ground with top capacitance ⁸⁾		3 ± 4.8 dB	h	$160 \pi^2 \left(\frac{h}{\lambda}\right)^2$	$3 \cdot \sqrt{10} \cdot \frac{\sqrt{P/W}}{r/\text{km}}$	$300 \cdot \frac{\sqrt{P/kW}}{r/\text{km}}$
Short dipole without end capacitance ⁷⁾		1.5 ± 1.8 dB	$\frac{l}{2}$	$20 \pi^2 \left(\frac{l}{\lambda}\right)^2$	$3 \cdot \sqrt{5} \cdot \frac{\sqrt{P/W}}{r/\text{km}}$	$212 \cdot \frac{\sqrt{P/kW}}{r/\text{km}}$
Short antenna on infinitely conducting ground without top capacitance ⁸⁾		3 ± 4.8 dB	$\frac{h}{2}$	$40 \pi^2 \left(\frac{h}{\lambda}\right)^2$	$3 \cdot \sqrt{10} \cdot \frac{\sqrt{P/W}}{r/\text{km}}$	$300 \cdot \frac{\sqrt{P/kW}}{r/\text{km}}$
Half-wave dipole		1.64 ± 2.15 dB	$\frac{\lambda}{\pi}$	73.2	$7 \cdot \frac{\sqrt{P/W}}{r/\text{km}}$	$221 \cdot \frac{\sqrt{P/kW}}{r/\text{km}}$
Quarter-wave antenna on infinitely conducting ground		3.28 ± 5.2 dB	$\frac{\lambda}{2\pi}$	36.6	$10 \cdot \frac{\sqrt{P/W}}{r/\text{km}}$	$316 \cdot \frac{\sqrt{P/kW}}{r/\text{km}}$
Small single-turn loop in free space		1.5 ± 1.8 dB	$\frac{2\pi A}{\lambda}$	$80 \pi^2 \frac{4\pi^2 A^2}{\lambda^4}$	$3 \cdot \sqrt{5} \cdot \frac{\sqrt{P/W}}{r/\text{km}}$	$212 \cdot \frac{\sqrt{P/kW}}{r/\text{km}}$
Full-wave dipole		2.4 ± 3.8 dB	>> λ	200 Ω	$6 \cdot \sqrt{2} \cdot \frac{\sqrt{P/W}}{r/\text{km}}$	$268 \cdot \frac{\sqrt{P/kW}}{r/\text{km}}$
Folded half-wave dipole		1.64 ± 2.15 dB	$\frac{2\lambda}{\pi}$	4 · 73.2 ≈ 280	$7 \cdot \frac{\sqrt{P/W}}{r/\text{km}}$	$221 \cdot \frac{\sqrt{P/kW}}{r/\text{km}}$
Turnstile antenna (Hertz dipole) radiating in horizontal plane		0.75 ± 1.2 dB	l	$40 \pi^2 \left(\frac{l}{\lambda}\right)^2$	$\frac{3}{2} \cdot \sqrt{10} \cdot \frac{\sqrt{P/W}}{r/\text{km}}$	$150 \cdot \frac{\sqrt{P/kW}}{r/\text{km}}$
Broadside array (Hertz dipoles) (L >> λ)		$\sim \left(\frac{8}{3}\right) \cdot \left(\frac{L}{\lambda}\right)$			$2 \cdot \sqrt{30} \cdot \sqrt{\frac{l}{\lambda}} \cdot \frac{\sqrt{P/W}}{r/\text{km}}$	$346 \cdot \sqrt{\frac{l}{\lambda}} \cdot \frac{\sqrt{P/kW}}{r/\text{km}}$
Collinear array (Hertz dipoles) (L >> λ)		$\sim \left(\frac{4}{3}\right) \cdot \left(\frac{L}{\lambda}\right)$			$2 \cdot \sqrt{15} \cdot \sqrt{\frac{l}{\lambda}} \cdot \frac{\sqrt{P/W}}{r/\text{km}}$	$245 \cdot \sqrt{\frac{l}{\lambda}} \cdot \frac{\sqrt{P/kW}}{r/\text{km}}$
Antenna with directivity D		D			$\sqrt{30} \cdot \sqrt{D} \cdot \frac{\sqrt{P/W}}{r/\text{km}}$	$173 \cdot \sqrt{D} \cdot \frac{\sqrt{P/kW}}{r/\text{km}}$

⁵⁾ Corresponds to gain for a loss-free antenna.

⁶⁾ Loss-free antenna and surroundings.

⁷⁾ l < 0.2 λ.

⁸⁾ h < 0.2 λ.

ANTENNA SELECTION GUIDE

The Rohde&Schwarz antenna portfolio covers three main areas of application: monitoring, communications and measurement. Some antennas may be used for multiple applications. The following figures help users to quickly find the optimum solution for their specific application.

Overview of monitoring antennas								Page
Directional stationary monitoring antennas				R&S®HL451				48
				R&S®HL471				50
		R&S®HL210A3/R&S®HL410A3						52
					R&S®HL007A2			92
					R&S®HL223			100
					R&S®HL033			94
					R&S®HL040E			96
					R&S®AC308R2/R&S®AC308R3			140ff
					R&S®AC025DP			144
					R&S®HF918			172
Omnidirectional stationary monitoring antennas				R&S®HA230				34
					R&S®HK001E			110
					R&S®HK012E			112
					R&S®HK014E			114
					R&S®HK033			116
					R&S®AU600			128
					R&S®HF214			64
					R&S®HF902			66
					R&S®HF9070M			166
					Update R&S®HE202			74
					R&S®HE314A1			76
					Update R&S®HE302			72
					R&S®HE309E			70
					R&S®HK309			68
						R&S®AC004R1/L1		162
						R&S®AC004R2/L2		164
					R&S®HE500		86	
					R&S®HE600		88	
					R&S®HE010E		28	
					R&S®HE010D		26	
Mobile and semi-mobile monitoring						New R&S®AC005	136	
						R&S®AC008	138	
						R&S®HE016	30	
						R&S®HL024A1/S2/S7/S8/S9	146ff.	
						R&S®HL050/R&S®HL050S7	156	
						R&S®AC004R1/L1	162	
						R&S®AC004R2/L2	164	
						R&S®HF9070M	166	
						R&S®HE500	86	
						R&S®HE600	88	
Handheld monitoring				Update R&S®HE400			78	
					New R&S®HE400DC/HE400MW		80ff.	
				New R&S®HE400BC			84	
					New R&S®HE800-PA		132	
					R&S®HF907DC		134	
1 kHz	10 kHz	100 kHz	1 MHz	10 MHz	100 MHz	1 GHz	10 GHz	40 GHz
Frequency								

Overview of communications antennas		Page			
Stationary communications antennas	R&S®HL451	48			
	R&S®HL471	50			
	R&S®HL210A3/R&S®HL410A3	52			
	New R&S®HX002H0	38			
	R&S®HX002H1	40			
	New R&S®HX002H3	44			
	R&S®HK055S1	118			
	R&S®HK001E	110			
	R&S®HK012E	112			
	R&S®HK014E	114			
	R&S®HL033	94			
	R&S®HL223	100			
R&S®HL040E	96				
Mobile/manpack and tactical antennas	R&S®HK060	124			
	R&S®HK061	126			
	R&S®HK056	122			
	R&S®HK055L1	120			
	R&S®HA104/512	32			
R&S®AK503	36				
Shipboard antennas	R&S®HK001E	110			
	R&S®HK012E	112			
	R&S®HK014E	114			
	R&S®HK055S1	118			
	R&S®HX002H2	42			
	New R&S®HX002H3M	44			
	R&S®AD033V3	104			
	R&S®AD066FW	106			
	R&S®AD066ST	108			
R&S®AD016MC	168				
100 kHz	1 MHz	10 MHz	100 MHz	1 GHz	10 GHz
Frequency					

Overview of measurement antennas		Page						
	Update R&S®AM524	62						
EMI antennas for laboratory use	R&S®HM020E	24						
	R&S®HL562E	102						
	R&S®HF907	170						
	R&S®HK116E	90						
	R&S®HFH2-Z2E	56						
	R&S®HFH2-Z6E	58						
EMS antennas for laboratory use	New R&S®HL047	98						
	R&S®HL050E	160						
	R&S®HF907	170						
Antennas for temporary outdoor use	R&S®HL050/R&S®HL050S7	156						
	R&S®HL033	94						
	R&S®HL223	100						
	R&S®HL040E	96						
	R&S®HF918	172						
	R&S®HL562E	102						
1 kHz	10 kHz	100 kHz	1 MHz	10 MHz	100 MHz	1 GHz	10 GHz	Frequency

CHAPTER 1

HF ANTENNAS

Type	Designation	Page
R&S®HM020E	Triple-loop antenna	24
R&S®HE010D	Active HF dipole	26
R&S®HE010E	Active rod antenna	28
R&S®HE016	Active antenna system	30
R&S®HA104/512	HF whip antenna	32
R&S®HA230/403	HF receiving antenna	34
R&S®AK503	Mobile HF antenna	36
R&S®HX002H0	HF dipole with ATU	38
R&S®HX002H1	150 W HF dipole	40
R&S®HX002H2	150 W HF dipole	42
R&S®HX002H3/R&S®HX002H3M	HF dipole with ATU	44
R&S®FK002H0	Antenna tuning unit (1 kW)	46
R&S®HL451	Log-periodic HF antenna	48
R&S®HL471	Log-periodic HF antenna	50
R&S®HL210A3	Log-periodic HF antenna	52
R&S®HL410A3	Log-periodic HF antenna	54
R&S®HFH2-Z2E	Active loop antenna	56
R&S®HFH2-Z6E	Active rod antenna	58

R&S®HM020E TRIPLE-LOOP ANTENNA

9 kHz to 30 MHz

Fully automatic measurement of magnetic field strength



The R&S®HM020E is a large loop antenna system (LLAS) as defined in CISPR 16-1-4. It allows fully automatic measurement as described in CISPR 16-2-3. The product standards CISPR 15 and CISPR 14-1 as well as others require these measurements.

The EUT is placed on a wooden pedestal in the center of the loops.

The loop construction using a cut coaxial line provides excellent screening against the electric components of the interfering signals so that unambiguous test results are obtained.

Individual calibration in line with CISPR standards available.

Key facts

- ▶ Fully automatic measurements of the magnetic field strength in the X, Y and Z planes of an EUT placed at the antenna center
- ▶ Remote control via a Rohde & Schwarz EMI receiver
- ▶ Loop system suitable for mobile use and foldable into one plane
- ▶ Wooden pedestal for 100 kg load available permitting the loops to be moved freely
- ▶ Measuring method in line with CISPR 15 (refers to CISPR 16-1-4) and CISPR 16-2-3

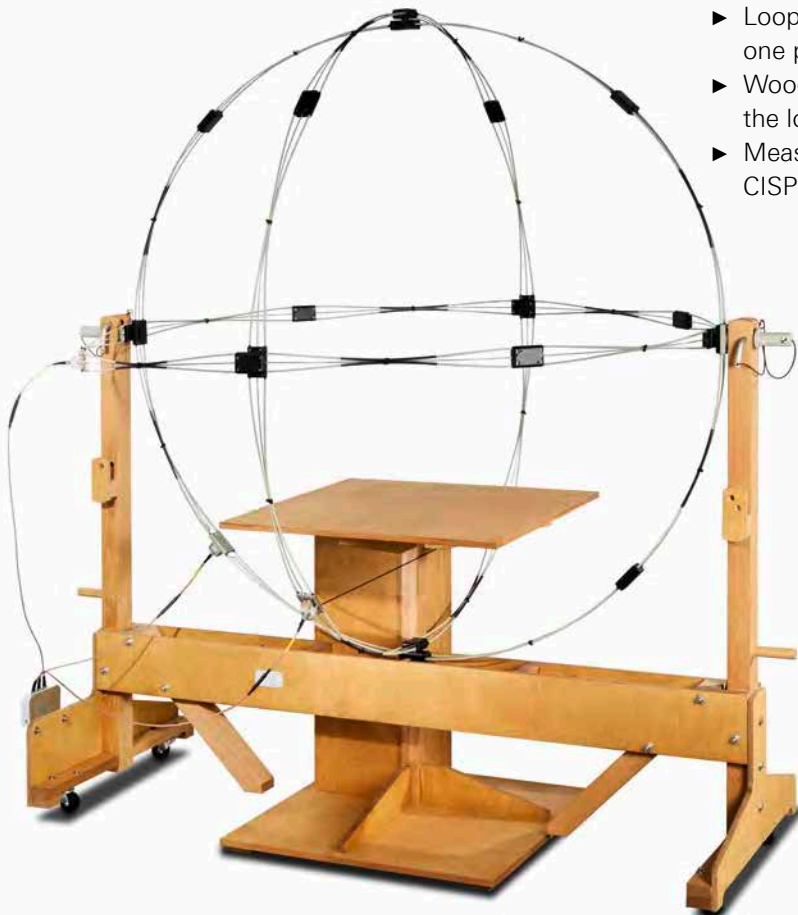

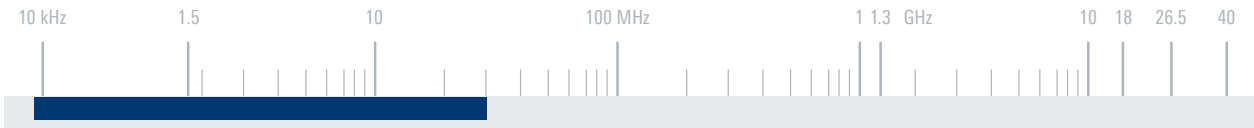

Specifications		
Frequency range		9 kHz to 30 MHz
Loop planes		switchable between X, Y and Z plane
Nominal impedance		50 Ω
RF connector		N female
Control connector		9-contact D-Sub female
MTBF		> 100 000 h
Operating temperature range		+5°C to +40°C
Dimensions (W × L × H)	loops set up	approx. 2.49 m × 2.07 m × 2.57 m (98 in × 82 in × 101 in)
	loops in transport crate	approx. 2.50 m × 0.43 m × 2.13 m (98 in × 17 in × 84 in)
	basic pedestal	approx. 0.9 m × 0.9 m × 1.0 m (35 in × 35 in × 39 in)
	adapter pedestal	approx. 0.9 m × 0.9 m × 0.5 m (max.) (35 in × 35 in × 20 in (max.))
Load capacity of pedestal		100 kg (221 lb)
Weight	loop system	approx. 45 kg (99 lb)
	basic pedestal	approx. 40 kg (88 lb)
	adapter pedestal	approx. 30 kg (66 lb)

Ordering information	Type	Order No.
Triple-loop antenna	R&S®HM020E	4108.9003.02
Recommended extras		
Basic pedestal	R&S®HM020Z1	4023.5504.02
Adapter pedestal	R&S®HM020Z2	4023.5604.02
Calibration dipole (LLAS verification dipole)	R&S®HM020Z3	4023.5704.02
Control unit (required for EMC receivers without user port)	R&S®BG020	4024.1002.02

Validation factor (meas.)

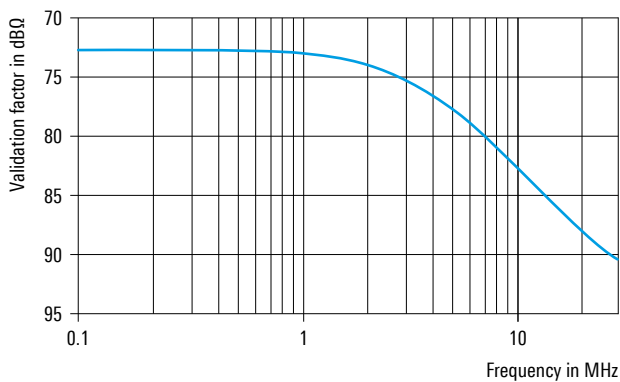

R&S®HE010D ACTIVE HF DIPOLE

100 kHz to 100 MHz

Sensitive monitoring in stationary or mobile installations



The R&S®HE010D active HF dipole is designed as a broadband monitoring antenna for horizontally or vertically polarized waves in the frequency range from 100 kHz to 100 MHz.

The main application of the antenna is sensitive monitoring in stationary or mobile installations.

The high sensitivity of the R&S®HE010D in combination with high interference immunity to large signal levels allows radiomonitoring and field strength measurements in a wide dynamic range.

Key facts

- ▶ Excellent wideband characteristics
- ▶ Low inherent noise
- ▶ Compact dimensions
- ▶ Easy exchange of antenna rods for service or removal for transportation
- ▶ Protected against overvoltage, which may occur as a result of atmospheric discharges or in the immediate vicinity of transmitting antennas



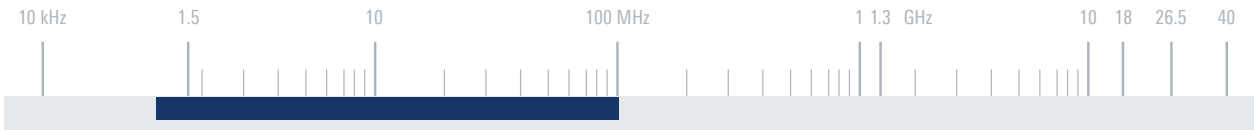

Specifications		
Frequency range		100 kHz to 100 MHz
Polarization		linear horizontal or vertical
Nominal impedance		50 Ω
VSWR	100 kHz to 200 kHz	< 3.5
	200 kHz to 100 MHz	< 2.5; typ. 2.0
Antenna factor	antenna mounted horizontally	typ. 2.0 dB (1/m)
Lower limit field strength (1 Hz)	100 kHz to 1 MHz	frequency dependent, see diagram
	> 1 MHz to 100 MHz	typ. < -35 dB(μV/m)
IP2	up to 50 MHz	typ. 60 dBm
	50 MHz to 100 MHz	typ. 48 dBm
IP3	1 MHz to 100 MHz	typ. 30 dBm
Power supply		24 V DC (-3 V/+1 V) (max. 150 mA)
RF connector		N female
MTBF		> 100 000 h
Operating temperature range		-40°C to +65°C
Storage temperature range		-40°C to +85°C
Protection class		IPx5, in line with EN 60529
Max. wind speed	without ice deposit	200 km/h
	with 30 mm ice deposit	180 km/h
Dimensions		approx. 1.75 m × 0.13 m × 0.14 m (69 in × 5 in × 5 in)
Weight		approx. 1.2 kg (3 lb)

Ordering information	Type	Order No.
Active HF dipole	R&S®HE010D	
Color: squirrel gray (RAL 7000)		4097.8007.02
Color: bronze green (RAL 6031)		4097.8007.03
Color: light ivory (RAL 1015)		4097.8007.04
Recommended extras		
Bias unit	R&S®IN600	4094.3004.xx
Mast, length: 6 m, pluggable	R&S®KM011	0273.9116.02

Typical lower limit field strength level (SNR = 1, directivity = 1.8 dBi) compared to ITU-R P.372-8 rural noise

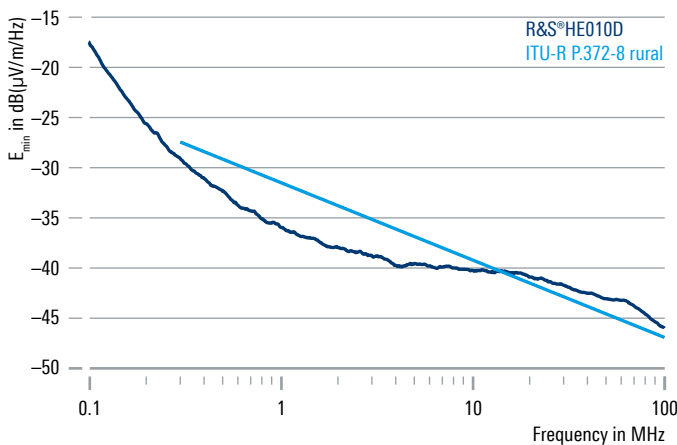

Typical elevation field pattern for horizontally installed antenna on a 6 m mast above perfectly conducting ground

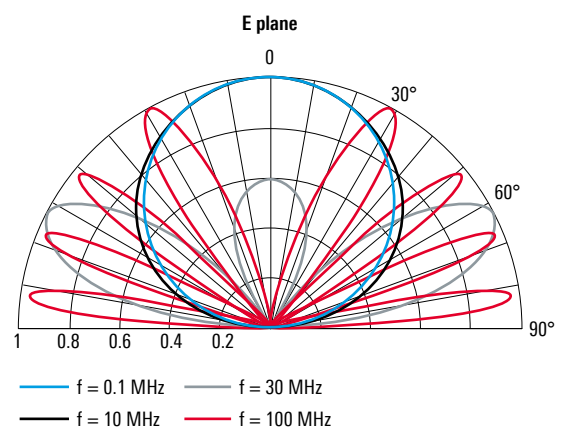

R&S®HE010E ACTIVE ROD ANTENNA

8.3 kHz to 100 MHz

Sensitive monitoring in stationary and mobile applications



The R&S®HE010E active rod antenna is designed as a broadband monitoring antenna for vertically polarized waves.

Its main application is sensitive monitoring in stationary and mobile applications where it offers very good reception results due to its low inherent noise figure, which is comparable to, and even below, the atmospheric or man-made noise.

The high sensitivity of the R&S®HE010E in combination with high interference immunity to large signals allows sensitive radiomonitoring and field strength measurements over a wide dynamic range.

Key facts

- ▶ Excellent wideband characteristics
- ▶ Low inherent noise figure
- ▶ High sensitivity in combination with high interference immunity to large signals
- ▶ Compact dimensions (rod length: 1 m)
- ▶ Protected against overvoltage that can occur as a result of atmospheric discharges or in the immediate vicinity of transmitting antennas



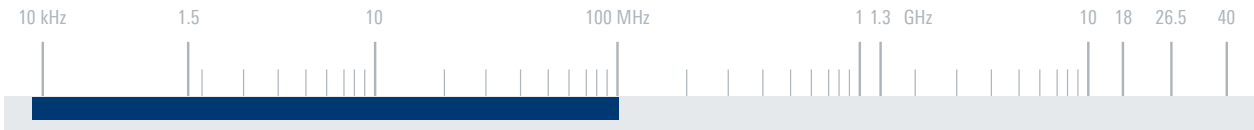

Specifications		
Frequency range		8.3 kHz to 100 MHz
Polarization		vertical
Input impedance		50 Ω
VSWR	8.3 kHz to 20 kHz	< 4.5
	20 kHz to 100 MHz	< 2
Antenna factor	antenna mounted on conductive plane	typ. 11 dB (1/m)
Lower limit field strength (1 Hz)	8.3 kHz to 500 kHz	frequency dependent, see diagram
	> 500 kHz to 100 MHz	typ. < -40 dB(μV/m)
IP2	up to 30 MHz	> 50 dBm; typ. 60 dBm
	30 MHz to 100 MHz	> 40 dBm
IP3	up to 30 MHz	> 30 dBm; typ. 33 dBm
	30 MHz to 100 MHz	> 20 dBm
Power supply		24 V DC (-3 V/+2 V) (max. 190 mA)
Connector		N female
MTBF		> 100000 h
Operating temperature range		-40°C to +65°C
Storage temperature range		-40°C to +85°C
Protection class		IP55, in line with EN 60529
Max. wind speed	without ice deposit	275 km/h
Dimensions	∅ × L	approx. 120 mm × 1000 mm (4.7 in × 39.4 in)
Weight		approx. 1 kg (2.2 lb)

Ordering information	Type	Order No.
Active rod antenna	R&S®HE010E	
Color: squirrel gray (RAL 7000)		4097.6004.02
Color: bronze green (RAL 6031)		4097.6004.03
Color: light ivory (RAL 1015)		4097.6004.04
Recommended extra		
Bias unit	R&S®IN600	4094.3004.xx

Vertical radiation pattern

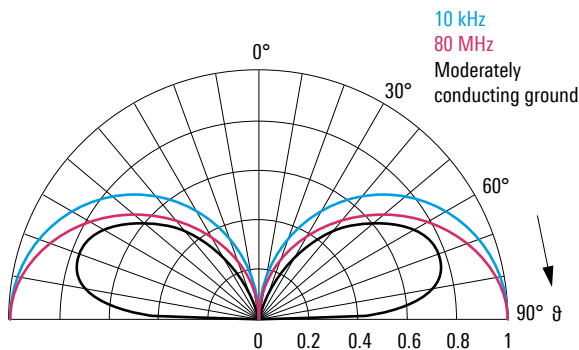

Typical lower limit field strength level (SNR = 1, directivity = 4.8 dBi) compared to ITU-R P.372-8 rural noise

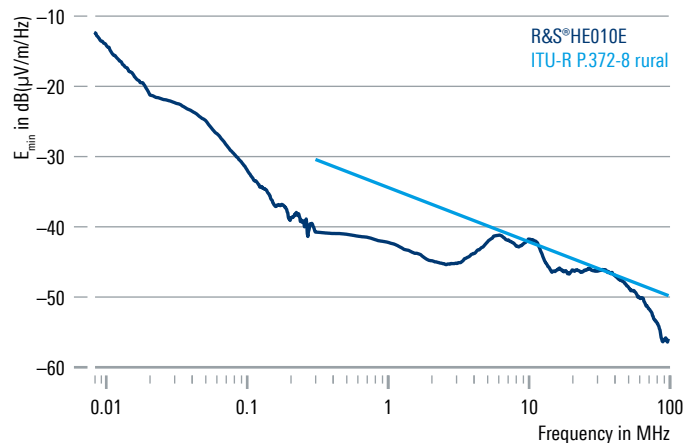

R&S®HE016 ACTIVE ANTENNA SYSTEM

9 kHz to 80 MHz (vertical)

600 kHz to 40 MHz (horizontal)

Omnidirectional reception of vertically and horizontally polarized signals



The R&S®HE016 active antenna system is a combination of the R&S®HE010E active rod antenna and two crossed HF dipole antennas. The two horizontal dipole antennas are combined via a 90° coupler to produce an omnidirectional radiation pattern.

The high sensitivity of the antenna system is comparable to that of passive systems, though the R&S®HE016 requires less than one third of the antenna surface of a passive system.

Key facts

- ▶ Omnidirectional reception of horizontally and vertically polarized signals
- ▶ High linearity
- ▶ High immunity to lightning strikes in the vicinity
- ▶ Extremely compact
- ▶ High sensitivity – comparable to that of passive antennas that are three times larger

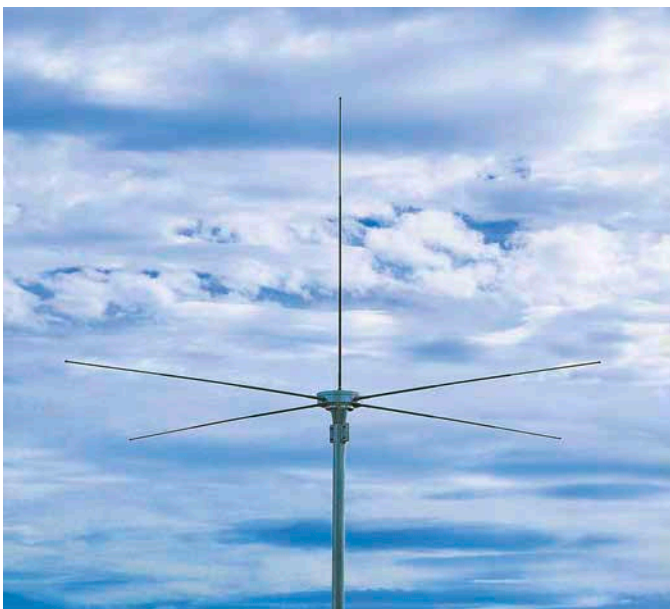

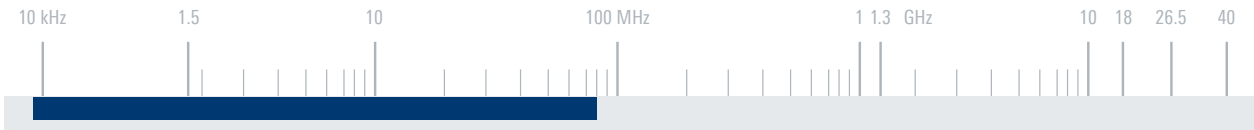

Specifications		
Frequency range	vertical polarization	9 kHz to 80 MHz
	horizontal polarization	600 kHz to 40 MHz
Input impedance		50 Ω
VSWR	9 kHz to 20 kHz	< 3
	20 kHz to 80 MHz	< 2
Sensitivity	vertical (> 1 MHz)	< -50 dB(uV/m/Hz)
	horizontal	< -30 dB(uV/m/Hz)
IP2	up to 30 MHz	≥ 50 dBm
IP3	up to 30 MHz	≥ 30 dBm
Power supply		21 V to 26 V DC (max. 500 mA)
Power consumption	vertical	max. 160 mA at 24 V DC
	horizontal	max. 340 mA at 24 V DC
Connector		2 × N female
MTBF		> 25000 h
Operating temperature range		-40°C to +65°C
Protection class		IP55
Max. wind speed	without ice deposit	188 km/h
Dimensions	∅ × H	approx. 2.85 m × 1.4 m (9 ft × 6 ft)
Weight		approx. 5.5 kg (12 lb)

Ordering information	Type	Order No.
Active antenna system	R&S®HE016	4051.8504.02
Recommended extras		
Bias unit	R&S®IN600	4094.3004.x2
Mast, length: 6 m, pluggable	R&S®KM011	0273.9116.02

Typical radiation patterns

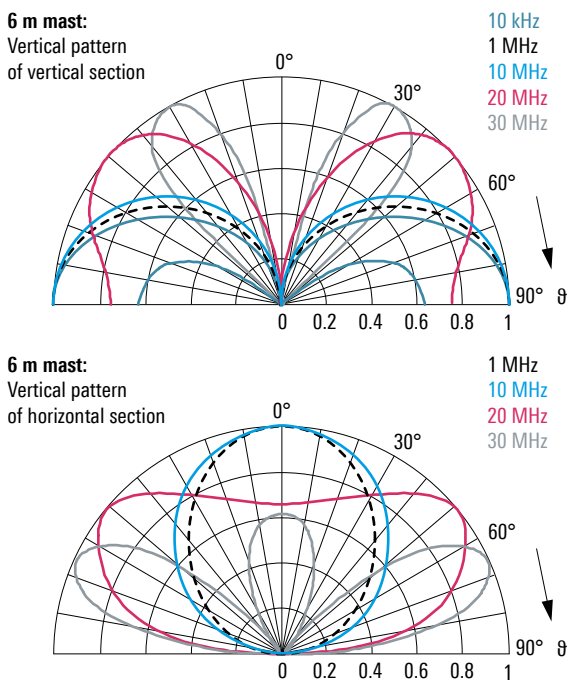

Typical inherent noise compared with different standard noise environments

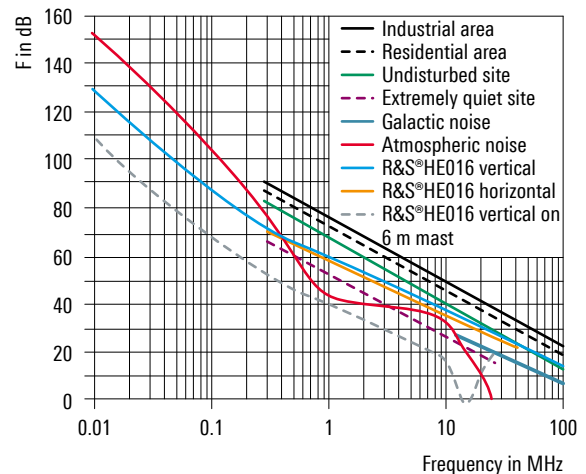

R&S® HA104/512 HF WHIP ANTENNA

1.5 MHz to 30 MHz

For ground waves and vertically polarized low-angle skywaves



The R&S®HA104/512 HF whip antenna is suitable for ground waves and vertically polarized low-angle skywaves.

In conjunction with an antenna tuning unit, it can also be used for transmission.

The sturdy, shock- and vibration-proof construction makes the R&S®HA104/512 ideal for mobile use.

For use on vehicles, the R&S®HA104/512 can be tied down when the vehicle is in motion.

Key facts

- ▶ Sturdy construction
- ▶ Shock- and vibration-proof
- ▶ Optimal for mobile use
- ▶ Suitable ATU available



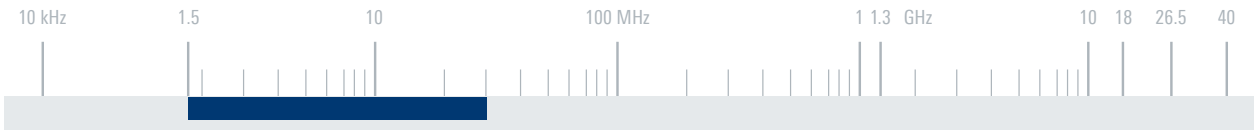

Specifications

Frequency range	transmission (with ATU)	1.5 MHz to 30 MHz
Polarization		linear/vertical
Max. input power		150 W CW/150 W PEP
Horizontal radiation pattern		omnidirectional
Connector		clamp
MTBF		> 100 000 h
Operating temperature range		-30°C to +55°C
Max. wind speed	without ice deposit	150 km/h
Height of antenna		approx. 5 m (16 ft)
Disassembly possible		yes
Weight		approx. 4 kg (9 lb)

Ordering information

Ordering information	Type	Order No.
HF whip antenna	R&S®HA104/512	0156.2039.02

Recommended extra

Antenna tuning unit	R&S®FK3150	6095.5855.02
---------------------	------------	--------------

R&S®HA230/403 HF RECEIVING ANTENNA

1.5 MHz to 30 MHz

Also for polarization-diversity reception



The R&S®HA230/403 HF receiving antenna is a versatile shortwave antenna for both horizontally and vertically polarized waves.

The antenna consists of a mast head with a vertical monopole and two horizontal dipoles mounted at a 90° angle. The antenna is installed on a 6 m mast.

Made up of electrically isolated and decoupled radiators, the antenna is particularly suitable for polarization-diversity reception.

Key facts

- ▶ Radiators for horizontal reception
- ▶ Radiator for vertical reception
- ▶ Individual radiators decoupled from each other
- ▶ Suitable for polarization-diversity reception



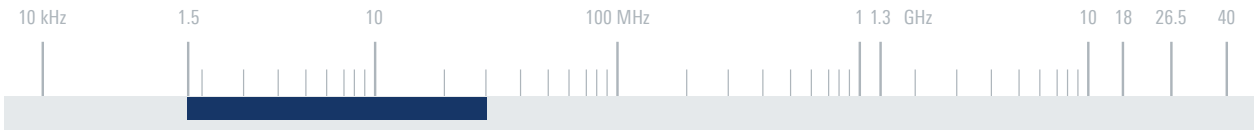

Specifications

Frequency range	1.5 MHz to 30 MHz	
Polarization	horizontal and vertical	
Input impedance	50 Ω	
Connectors	3 × N female	
MTBF	> 100 000 h	
Operating temperature range	-40°C to +65°C	
Max. wind speed	without ice deposit	150 km/h
Dimensions	length of radiators	approx. 5 m (16 ft)
	height	approx. 11 m (36 ft)
Weight (incl. mast)	approx. 85 kg (187 lb)	

Ordering information

	Type	Order No.
HF receiving antenna (stationary)	R&S®HA230/403	0101.1176.02
Consists of:		
Antenna head	R&S®HA230Z	0138.6313.00
Mast, length: 6 m	R&S®HA230M	0138.6342.00

Typical vertical radiation patterns for horizontal polarization

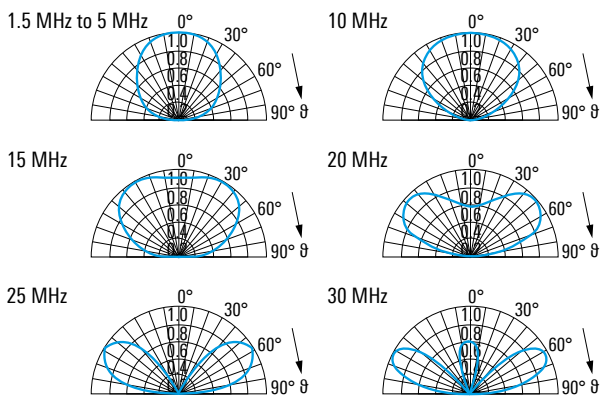

$h/\lambda = 0.03$ to 0.6

Vertical pattern of the relative field strength of the R&S®HA230/403 HF receiving antenna with horizontal polarization at an angle of 0° for ideally conducting ground (calculated).

Typical vertical radiation patterns for vertical polarization

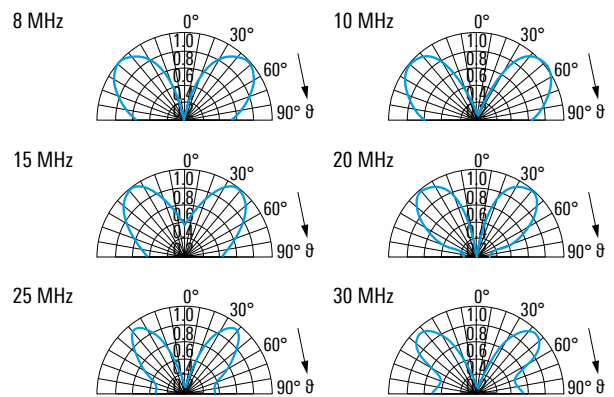

$h/\lambda = 0.16$ to 0.6

Vertical pattern of the relative field strength of the R&S®HA230/403 HF receiving antenna with vertical polarization for ideally conducting ground (calculated).

R&S®AK503 MOBILE HF ANTENNA

1.5 MHz to 30 MHz

Highly reliable HF antenna for mobile use



The R&S®AK503 mobile HF antenna has been designed especially for mobile use. Short installation and disassembly times and low space requirements for installation and transportation have been combined with good electrical characteristics.

Through optimized design with a focus on propagation conditions in the medium-wave and shortwave range, the antenna provides high reliability in radiocommunications.

The automatic R&S®FK3150 antenna tuning unit ensures optimum antenna tuning in the entire operating frequency range.

Switching between the three operating modes (optimized for specific frequency and distance ranges) is performed manually at the antenna head.

Key facts

- ▶ Coverage of all distance ranges
- ▶ No skip zone
- ▶ Omnidirectional coverage with high-angle radiation (NVIS)
- ▶ Omnidirectional coverage up to 1000 km due to null fill
- ▶ Installation time approx. 10 min

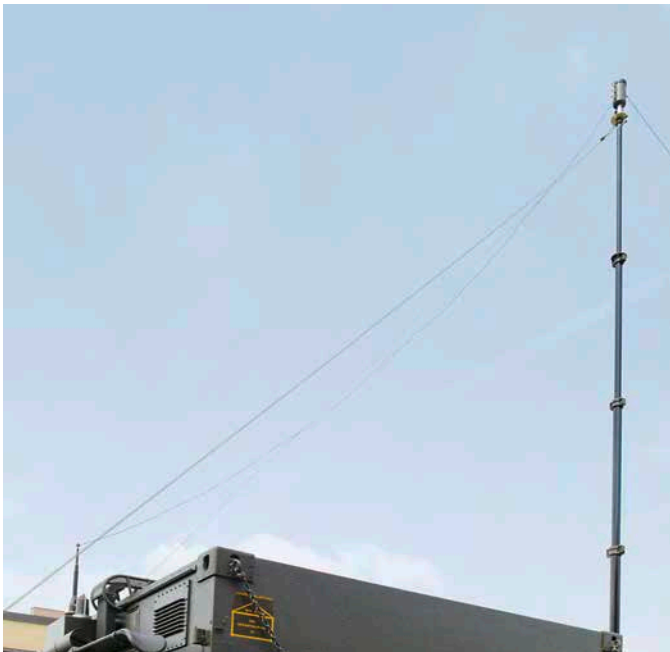

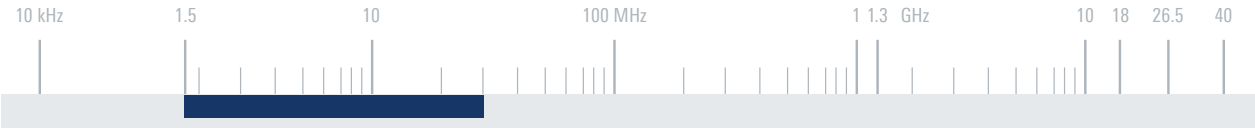

Specifications

Frequency range		1.5 MHz to 30 MHz
Max. input power		150 W CW
Recommended operating range	mode 1	1.5 MHz to 6 MHz
	mode 2	6 MHz to 30 MHz (optimized)
	mode 3	1.5 MHz to 30 MHz for ground-wave communications and distances > 2000 km
Connector		clamp
MTBF		> 100 000 h
Operating temperature range		-40°C to +55°C
Max. wind speed	without ice deposit	120 km/h
Dimensions	length including guy rope	approx. 35 m (115 ft)
	height	approx. 7 m to 11 m (23 ft to 36 ft)
Weight		approx. 4 kg (9 lb)

Ordering information	Type	Order No.
Mobile HF antenna	R&S®AK503	0448.3226.02

Recommended extras		
Antenna tuning unit	R&S®FK3150	6095.5855.02
Mast, length: 6 m, can be disassembled	R&S®KM011	0273.9116.02
Mast adapter for R&S®AK503 on R&S®KM011	R&S®KM011Z3	4021.7700.02

Typical azimuth patterns for various elevation angles

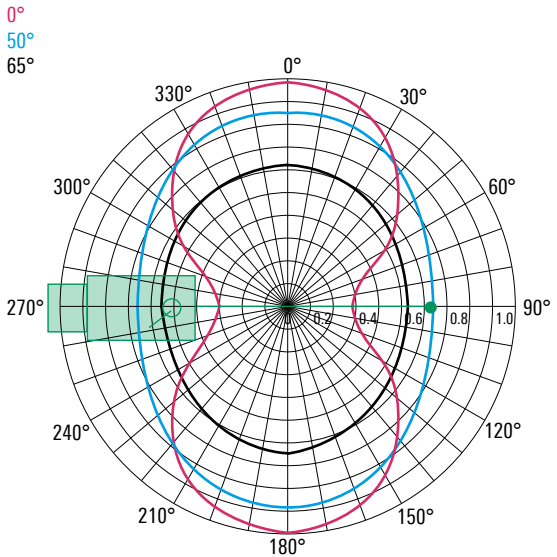

System overview with description of individual components

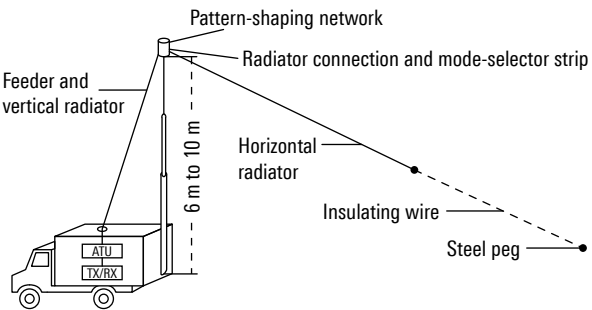

R&S®HX002H0 HF DIPOLE WITH ATU

1.6 MHz to 30 MHz

For stationary use and 1 kW transmit power

New



The R&S®HX002H0 HF dipole with ATU permits optimum coverage of all distance ranges. It is particularly useful for radiocommunications over short and medium distances, since below 1000 km vertical rod antennas do not ensure sufficient transmission reliability because of the skip zone.

The fully automatic ATU integrated in the antenna provides perfect matching to the transmitting system so that full RF output power capabilities are available. The high efficiency of the antenna is obtained because the matching network is directly located at the feed point of the dipole.

Together with the R&S®GX002, the R&S®HX002H0 can be seamlessly integrated into the R&S®Series4100 and R&S®M3TR radio systems. Furthermore, the R&S®HX002H0 can be controlled by a third-party system controller via LAN interface or it works fully automatically with a third-party transceiver when in autonomous mode.

Lightning protection circuitry is provided in the antenna head, at multiple locations inside the ATU and in the balun section.

Key facts

- ▶ High RF power at small antenna (1 kW, 5 m radiator radius)
- ▶ Omnidirectional coverage with high-angle radiation (NVIS), no skip zone
- ▶ Very compact dimensions, setup close to neighboring antennas possible
- ▶ High efficiency (no resistive loading)
- ▶ RF-cable-only interface
- ▶ Single supporting mast
- ▶ Cosite robust, fast tuning with low or zero RF power
- ▶ Transceiver-independent control interface and power supply (via R&S®GX002)
- ▶ Fully automatic operation possible (autonomous mode)



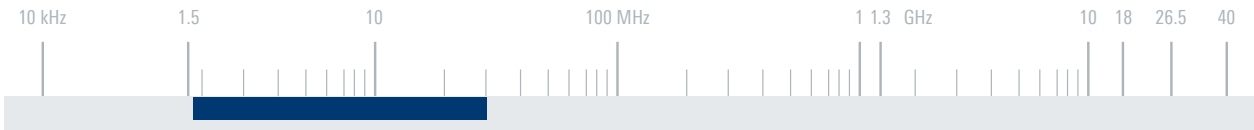

Specifications		
Frequency range		1.6 MHz to 30 MHz
Max. permissible RF input power		1 kW
Input impedance		50 Ω
VSWR	after tuning	≤ 1.8; typ. ≤ 1.3
Tuning time	silent tune/bypass activation	< 35 ms
	active tune	< 25 s; typ. < 8 s
	initial learning of whole frequency range	< 90 min
Tuning power	integrated antenna analyzer	≤ 1 W
Efficiency	at 2 MHz	> 20%
	f > 5 MHz	> 75%
Gain	depends on frequency, ground properties and mast height	-3.3 dBi to 7.8 dBi (typ.)
RF interface (with DC supply and control information)	to R&S®GX002	N female
Protection class		IPx6, waterproof, in line with IEC 60529
Max. wind speed	without ice deposit	275 km/h
Dimensions	ATU housing (W × D × H)	approx. 0.5 m × 0.5 m × 1.3 m (19.7 in × 19.7 in × 51.2 in)
	radiator-tip rectangle	approx. 9.6 m × 4.1 m (31.5 ft × 13.5 ft)
Weight		approx. 155 kg (341.7 lb)

Ordering information	Type	Order No.
HF dipole with ATU	R&S®HX002H0	4102.7009.02
Recommended extras		
Junction unit	R&S®GX002	4106.0009.02
Mast, length: 5 m, for roof mounting	R&S®KM002Z0	4115.9005.02
Tilt kit, for R&S®KM002Z0 mast	R&S®KM002Z0-K	4115.9505.02
Lattice mast, length: 10 m	R&S®KM451B1	4028.3351.02
Lattice mast, length: 15 m	R&S®KM451B2	4028.3400.02
Isolating rope set, for R&S®KM451B1/B2	R&S®KM002Z3	4115.9540.02
Legacy mast adapter, for e.g. old R&S®HX002Z1 mast	R&S®KM002Z2	4115.9640.02

Typical horizontal radiation pattern for various elevation angles θ

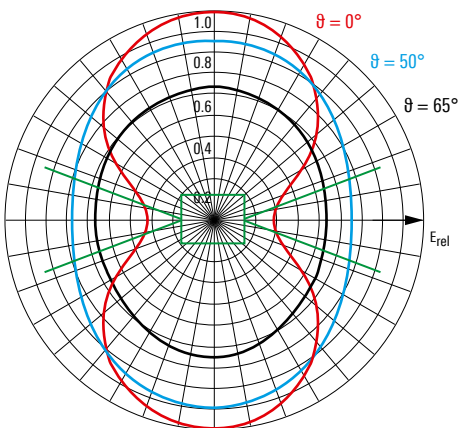

Typical vertical radiation pattern (12 m above an ideal conductive plane)

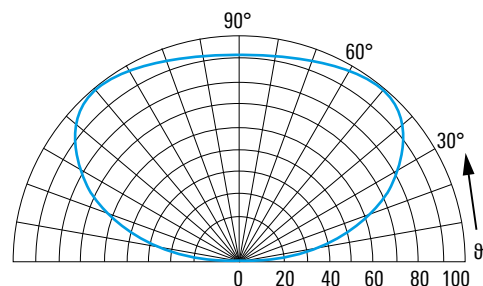

R&S®HX002H1 150 W HF DIPOLE

1.5 MHz to 30 MHz

With integrated antenna tuning unit for stationary applications



The R&S®HX002H1 150 W HF dipole is suitable for setting up radio links over any distance. In particular, the optimized omnidirectional coverage ensures high transmission reliability over short and medium distances.

The R&S®HX002H1 can be directly connected to R&S®M3SR Series4100 HF transceivers by means of the R&S®GK4102 fiber-optic control cable.

The antenna enables silent tuning over the entire frequency range from 1.5 MHz to 30 MHz. The integrated tuning unit must first learn the correct tuning settings for the antenna in a user-defined frequency range. The antenna then achieves tuning times of < 5 ms.

Special attention was paid to lightning protection. The integrated antenna tuning unit is protected against lightning strikes and was tested with 10 kV/10 kA discharges.

Key facts

- ▶ Omnidirectional coverage with high-angle radiation (NVIS)
- ▶ No skip zone
- ▶ Integrated antenna tuning unit for support of fast frequency hopping in line with R&S®SECOM-H
- ▶ Silent tuning
- ▶ Compatible with R&S®M3SR Series4100 HF transceivers
- ▶ Setup close to neighboring antennas possible



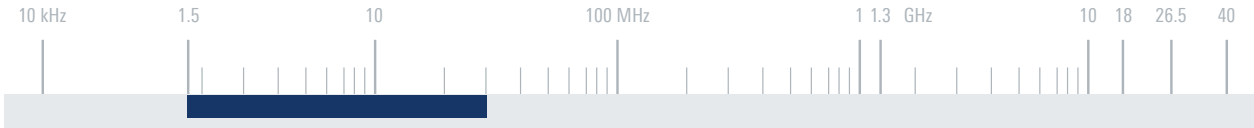

Specifications		
Frequency range		1.5 MHz to 30 MHz
Polarization	mainly vertical	1.5 MHz to 2 MHz
	mainly horizontal	2 MHz to 30 MHz
Input impedance		50 Ω
VSWR		< 1.5; typ. < 1.3
Max. input power		100 W CW/150 W PEP
Tuning time	initial tuning	< 4 s; typ. 1.5 s
	repeated tuning	typ. < 0.2 s
	silent tuning	< 5 ms
Tuning power		30 W ± 1 dB
Connector		N female
Operating temperature range		-30°C to +55°C ¹⁾
Protection class		IP66
Max. wind speed (survival)	without ice deposit	250 km/h
	with 20 mm radial ice deposit	130 km/h
Dimensions	W × L	approx. 4.4 m × 10.7 m (14 ft × 35 ft)
Weight		approx. 43 kg (95 lb)

¹⁾ Partial power reduction at > +35°C.

Ordering information	Type	Order No.
150 W HF dipole	R&S®HX002H1	6120.7000.02
Recommended extras		
Fiber-optic control cable	R&S®GK4102	
10 m		6120.5707.10
25 m		6120.5707.25
50 m		6120.5707.50
Tiltable mast, length: 5 m, for roof mounting	R&S®KM002A1	4035.7359.02
Lattice mast, length: 10 m	R&S®KM451B1	4028.3351.02
Lattice mast, length: 15 m	R&S®KM451B2	4028.3400.02
Isolating rope set, for R&S®KM451B1/B2	R&S®KM002Z3	4115.9540.02
Mast adapter, for R&S®HX002A1/HX002H1 on R&S®KM451B1/B2/B3	R&S®KM451Z5	4039.8308.03

Typical gain on a 5 m mast above perfectly conducting ground

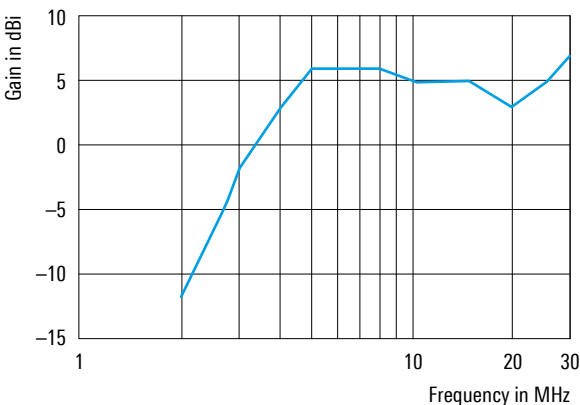

Typical vertical radiation patterns on a 5 m mast above perfectly conducting ground

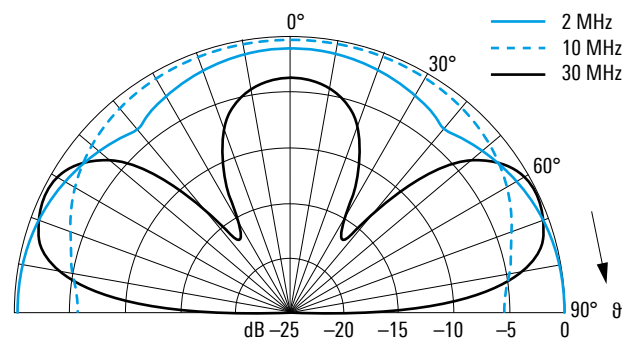

R&S®HX002H2 150 W HF DIPOLE

1.5 MHz to 30 MHz

With integrated antenna tuning unit optimized for shipboard applications



The R&S®HX002H2 150 W HF dipole is suitable for setting up radio links over any distance. In particular, the optimized omnidirectional coverage ensures high transmission reliability over short and medium distances.

The R&S®HX002H2 can be directly connected to R&S®M3SR Series4100 HF transceivers by means of the R&S®GK4102 fiber-optic control cable.

The antenna enables silent tuning over the entire frequency range from 1.5 MHz to 30 MHz. The integrated tuning unit must first learn the correct tuning settings for the antenna in a user-defined frequency range. The antenna then achieves tuning times of < 5 ms.

Special attention was paid to lightning protection. The integrated antenna tuning unit is protected against direct lightning strikes and was tested with 10 kV/10 kA discharges.

Key facts

- ▶ Omnidirectional coverage with high-angle radiation (NVIS)
- ▶ No skip zone
- ▶ Integrated antenna tuning unit for support of fast frequency hopping in line with R&S®SECOM-H
- ▶ Silent tuning
- ▶ Compatible with R&S®M3SR Series4100 HF transceivers
- ▶ Setup close to neighboring antennas possible
- ▶ Optimized for use on ships



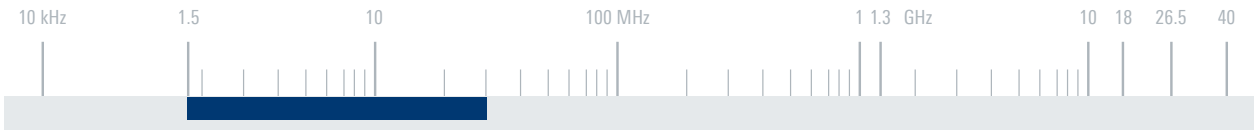

Specifications		
Frequency range		1.5 MHz to 30 MHz
Polarization	mainly vertical	1.5 MHz to 2 MHz
	mainly horizontal	2 MHz to 30 MHz
Input impedance		50 Ω
VSWR		< 1.5; typ. < 1.3
Max. input power		100 W CW/150 W PEP
Tuning time	initial tuning	< 4 s; typ. 1.5 s
	repeated tuning	typ. < 0.2 s
	silent tuning	< 5 ms
Tuning power		30 W ± 1 dB
Connector		N female
Operating temperature range		-30°C to +55°C ¹⁾
Protection class		IP66
Max. wind speed (survival)	without ice deposit	250 km/h
	with 20 mm radial ice deposit	140 km/h
Dimensions	W × L	approx. 2.2 m × 5.2 m (7 ft × 17 ft)
Weight		approx. 32 kg (71 lb)

¹⁾ Partial power reduction at > +35°C.

Ordering information	Type	Order No.
150 W HF dipole	R&S®HX002H2	6120.8006.02
Recommended extra		
Fiber-optic control cable	R&S®GK4102	
10 m		6120.5707.10
25 m		6120.5707.25
50 m		6120.5707.50

Typical three-dimensional radiation patterns above perfectly conducting ground

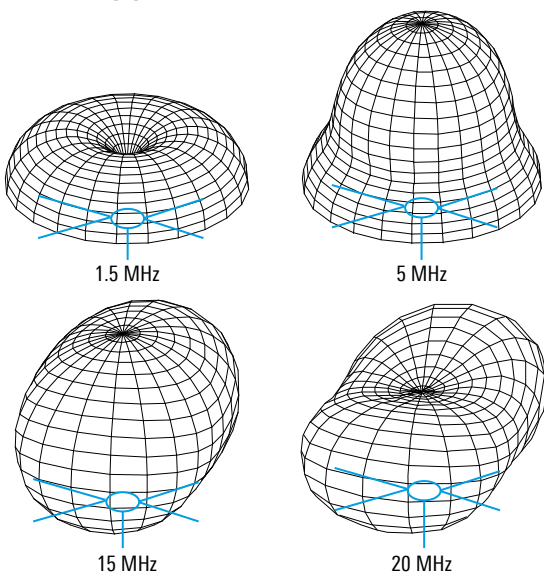

Typical gain on a 5 m mast above perfectly conducting ground

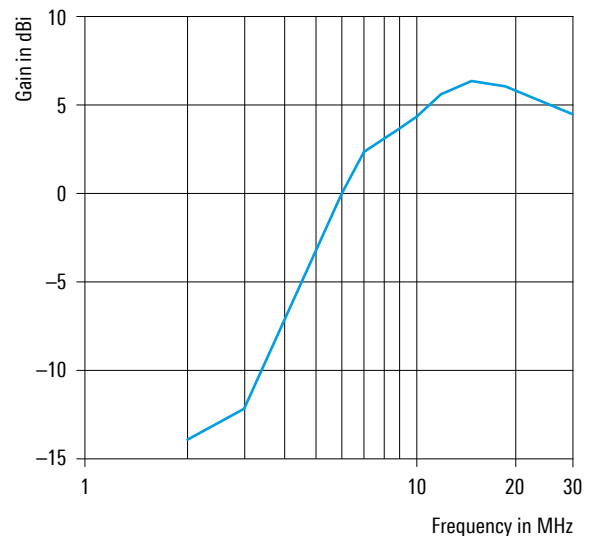

R&S®HX002H3/ R&S®HX002H3M HF DIPOLE WITH ATU

1.5 MHz to 30 MHz

For stationary use or for shipboard applications

New



The R&S®HX002H3 HF dipole with ATU permits optimum coverage of all distance ranges. It is particularly useful for radiocommunications over short and medium distances, since below 1000 km vertical rod antennas do not ensure sufficient transmission reliability because of the skip zone.

The fully automatic ATU integrated in the antenna provides perfect matching to the transmitting system so that full RF output power capabilities are available. The high efficiency of the antenna is obtained because the matching network is directly located at the feed point of the dipole.

Together with R&S®GX002, the R&S®HX002H3 can be seamlessly integrated into the R&S®Series4100 and R&S®M3TR radio systems. Furthermore, the R&S®HX002H3 can be controlled by a third-party system controller via LAN interface or it works fully automatically with a third-party transceiver when in autonomous mode.

Lightning protection circuitry is provided at multiple locations inside the ATU.

The R&S®HX002H3M is especially optimized for naval applications.

Key facts

- ▶ Suitable for transmitter powers up to 150 W
- ▶ Omnidirectional coverage with high-angle radiation (NVIS), no skip zone
- ▶ Integrated antenna tuning unit with support of fast frequency hopping in line with R&S®SECOM-H
- ▶ High efficiency (no resistive loading)
- ▶ Very compact dimensions, setup close to neighboring antennas possible
- ▶ RF-cable-only interface
- ▶ Single supporting mast
- ▶ Cosite robust, fast tuning with low or zero RF power
- ▶ Transceiver-independent control interface and power supply (via R&S®GX002)
- ▶ Fully automatic operation possible (autonomous mode)



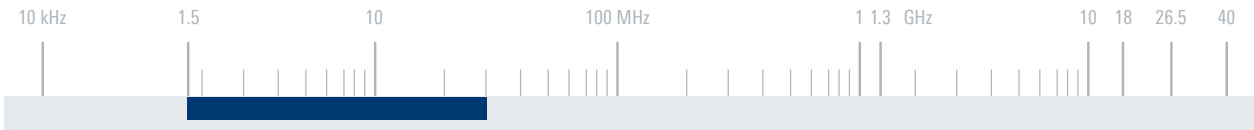

Specifications		
Frequency range		1.5 MHz to 30 MHz
Max. permissible RF input power		100 W CW, 150 W PEP
Input impedance		50 Ω
VSWR	after tuning	≤ 1.8; typ. ≤ 1.3
Tuning time	silent tune/bypass activation	< 5 ms
	active tune	< 5 s
Tuning power	integrated antenna analyzer	≤ 1 W
Gain	depends on frequency, ground properties and mast height	-3.3 dBi to 7.8 dBi (typ.)
RF interface (with DC supply and control information)	to R&S®GX002	N female
Operating temperature range		-40°C to +65°C
Protection class		IPx6, waterproof
Max. wind speed	without ice deposit	275 km/h
Dimensions (W × D × H)	R&S®HX002H3	approx. 9.5 m × 4 m × 1.8 m (31.2 ft × 13.1 ft × 5.9 ft)
	R&S®HX002H3M	approx. 4.5 m × 2.5 m × 1.8 m (14.8 ft × 8.2 ft × 5.9 ft)
Weight	R&S®HX002H3	approx. 50 kg (110.2 lb)
	R&S®HX002H3M	approx. 35 kg (77.2 lb)

Ordering information	Type	Order No.
HF dipole with ATU	R&S®HX002H3	4015.6003.02
HF dipole with ATU	R&S®HX002H3M	4015.6003.12
Recommended extras		
Junction unit	R&S®GX002	4106.0009.02
Tiltable mast, length: 5 m, for roof mounting	R&S®KM002A1	4035.7359.02
Lattice mast, length: 10 m	R&S®KM451B1	4028.3351.02
Lattice mast, length: 15 m	R&S®KM451B2	4028.3400.02
Isolating rope set, for R&S®KM451B1/B2	R&S®KM002Z3	4115.9540.02
Mast adapter, for R&S®HX002A1/HX002H1 on R&S®KM451B1/B2/B3	R&S®KM451Z5	4039.8308.03

Typical gain on a 5 m mast above perfectly conducting ground

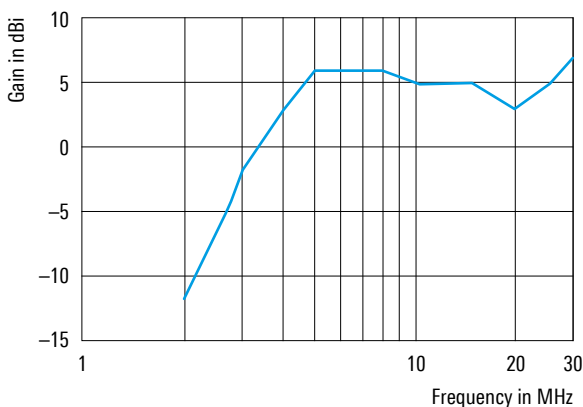

Typical vertical radiation patterns above perfectly conducting ground

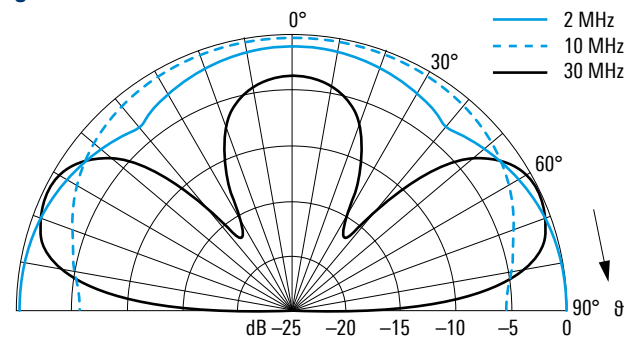

R&S®FK002H0 ANTENNA TUNING UNIT (1 KW)

1.5 MHz to 30 MHz

For stationary, land-mobile and shipboard applications

New



The R&S®FK002H0 is a standalone antenna tuning unit (ATU). It can match the impedance of a radiator to 50 Ω for every frequency from 1.5 MHz and 30 MHz.

The R&S®FK002H0 is powered and controlled by the R&S®GX002 junction unit.

The R&S®FK002H0 can be operated under harsh environmental conditions and continuous 24-hour operation. The rugged, waterproof and dustproof construction of the R&S®FK002H0 allows its use in stationary, land-mobile and shipboard applications.

Together with the R&S®GX002, the R&S®FK002H0 is seamlessly integrable into the R&S®Series4100 radio systems. Furthermore, the R&S®FK002H0 can be controlled by a third-party system controller via LAN interface or it works fully automatically with a third-party transceiver when in autonomous mode.

For cooling, the R&S®FK002H0 is provided with a sophisticated internal air circulation system.

Key facts

- ▶ High RF power at small antennas (1 kW RF power at rod antennas starting at 7 m)
- ▶ High efficiency (no resistive loading)
- ▶ HF-cable-only interface
- ▶ Cosite robust, fast tuning with low RF power (active tune) or zero RF power (silent tune)
- ▶ Transceiver-independent control interface and power supply (via R&S®GX002)
- ▶ Fully automatic operation possible (autonomous mode)



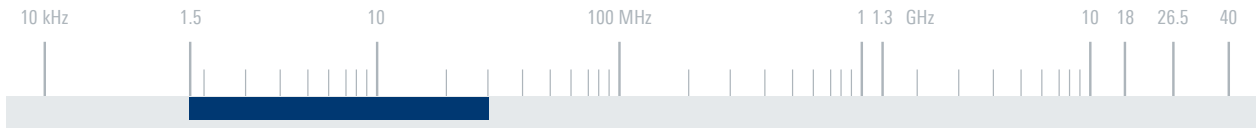

Specifications

Frequency range	1.5 MHz to 30 MHz	
Max. permissible RF input power	1 kW	
Input impedance	nom. 50 Ω	
Permissible antennas	monopole antennas with radiator length from 7 m to 12 m (e.g. R&S®HA175) wire antennas with radiator length from 8 m to 30 m (e.g. R&S®AK503)	
VSWR after tuning	≤ 1.8 ; typ. ≤ 1.3	
Tuning time	silent tune/bypass activation	< 35 ms
	active tune	< 25 s; typ. < 8 s
Tuning power	integrated antenna analyzer	≤ 1 W
Efficiency	depends on frequency and connected antenna	20% to 90% (typ.)
Power supply	via R&S®GX002	max. 150 W
Protection class	IPx6, waterproof, in line with IEC 60529	
Dimensions	L x W x H	approx. 0.45 m x 0.45 m x 0.58 m (17.7 in x 17.7 in x 22.8 in)
Weight	approx. 54.5 kg (120.2 lb)	

Ordering information

Ordering information	Type	Order No.
Antenna tuning unit (1 kW)	R&S®FK002H0	4105.8006.02
Recommended extras		
Junction unit	R&S®GX002	4106.0009.02
HF rod antenna	R&S®HA175	0101.1101.02

Typical efficiency for rod antenna at height of 7 m to 10 m

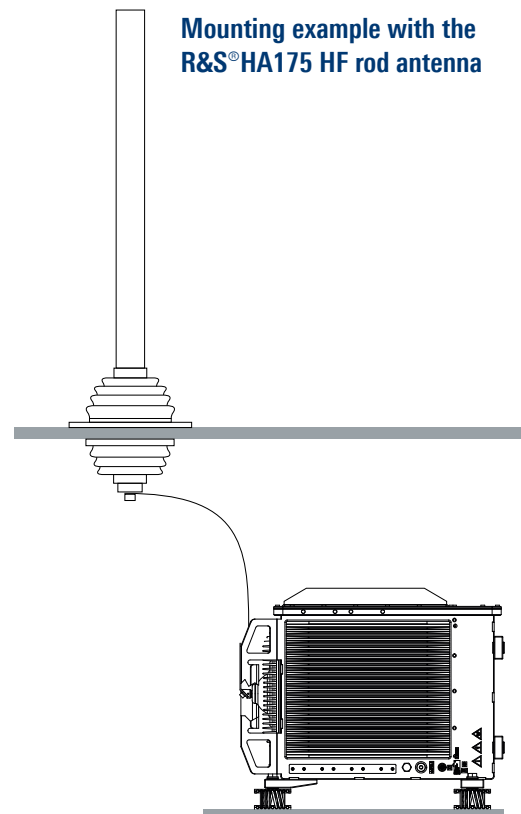
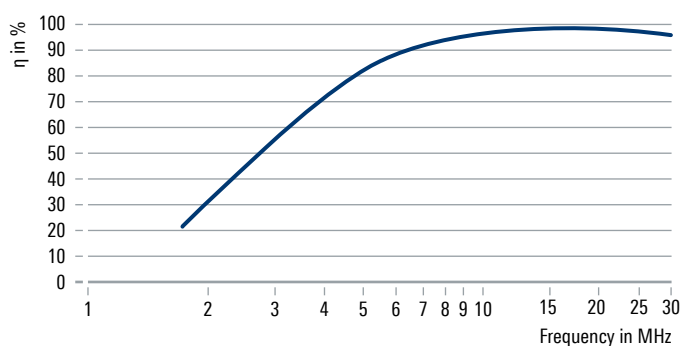

R&S®HL451 LOG-PERIODIC HF ANTENNA

2 MHz to 30 MHz

Transmission and reception of horizontally polarized waves over medium and long distances



The compact, rotatable R&S®HL451 log-periodic HF antenna can be used for transmission and reception of horizontally polarized waves.

The antenna's transmission frequency range from 5 MHz to 30 MHz makes it particularly suitable for communications over medium and long distances. Reception is possible from 2 MHz so that all distances can be covered.

The antenna has been optimized for small size, low weight and minimum maintenance.

Key facts

- ▶ Reception from 2 MHz
- ▶ Transmission from 5 MHz
- ▶ Unshortened half-wave elements for high gain despite extremely small size
- ▶ Easy and quick assembly
- ▶ Low maintenance
- ▶ Suitable for roof mounting



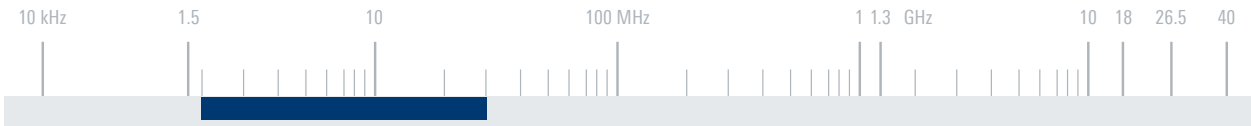

Specifications

Frequency range		
Reception		2 MHz to 30 MHz
Transmission		5 MHz to 30 MHz
Polarization		linear/horizontal
Input impedance		50 Ω
VSWR	5 MHz to 30 MHz	≤ 2
Max. input power		1 kW CW/2 kW PEP
Gain (on 15 m mast)	5 MHz to 30 MHz	6 dBi to 12.5 dBi
Max. wind speed	without ice deposit	180 km/h
Connector		N female
MTBF		> 100 000 h
Operating temperature range		-30°C to +50°C
Dimensions of antenna array	W × L	approx. 16 m × 15 m (53 ft × 49 ft)
Weight of antenna array		approx. 260 kg (573 lb)

Ordering information

Ordering information	Type	Order No.
Log-periodic HF antenna	R&S®HL451	0733.8507.02

Recommended extras

Lattice mast, length: 15 m (standard)	R&S®KM451B2	4028.3400.02
Lattice mast, length: 10 m (for roof mounting)	R&S®KM451B1	4028.3351.02
Hazard light	R&S®KM451F1	4028.3500.02
Antenna rotator	R&S®RD130	4059.8503.02
Rotary joint/adaption set	R&S®RD008Z1	0720.6400.02
Control unit	R&S®GB130	4059.8755.02
Set of cables (connecting R&S®GB130 to R&S®RD130, lengths: 50/80/120/200 m)	R&S®GK130	4059.8855.0x (x = 2/3/4/5)

Other configurations on request.

Typical radiation patterns on a 15 m mast

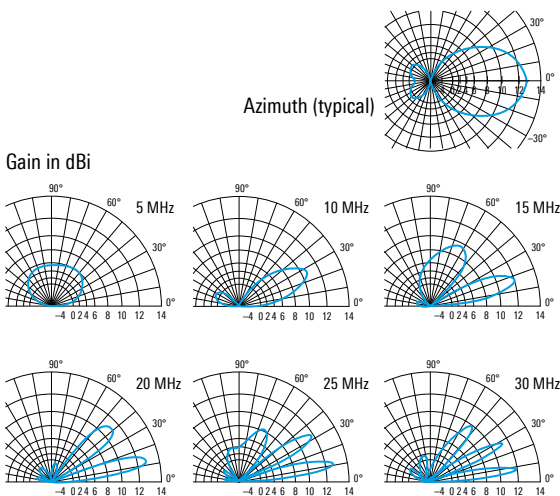

Typical gain

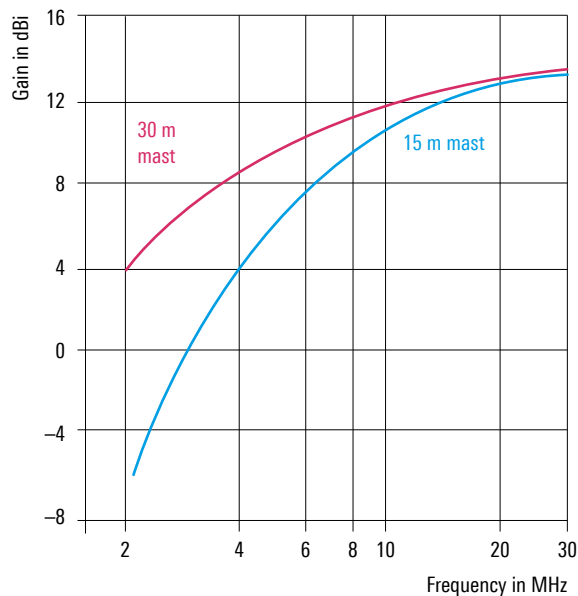

R&S®HL471 LOG-PERIODIC HF ANTENNA

5 MHz to 30 MHz

Transmission and reception of horizontally polarized waves over long distances



The compact, rotatable R&S®HL471 log-periodic HF antenna can be used for transmission and reception of horizontally polarized waves.

The antenna's transmission frequency range from 7 MHz to 30 MHz makes it particularly suitable for communications over long distances. Reception is possible from 5 MHz so that all distances can be covered.

The antenna has been optimized for small size, low weight and minimum maintenance.

Key facts

- ▶ Reception from 5 MHz
- ▶ Transmission from 7 MHz
- ▶ Extremely small size
- ▶ Low weight
- ▶ Easy and quick assembly
- ▶ Low maintenance
- ▶ Suitable for roof mounting



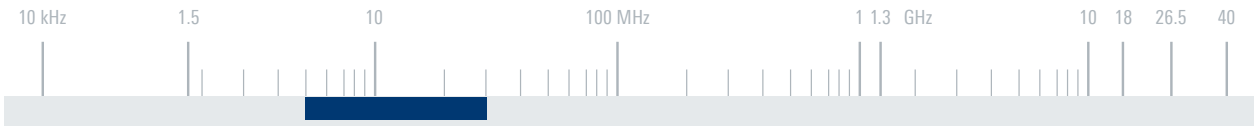

Specifications

Frequency range	reception	5 MHz to 30 MHz
	transmission	7 MHz to 30 MHz
Polarization		linear/horizontal
Input impedance		50 Ω
VSWR	7 MHz to 30 MHz	≤ 2
Max. input power		1 kW CW/2 kW PEP
Gain (on 15 m mast)	7 MHz to 8 MHz	0 dBi to 6 dBi
	8 MHz to 30 MHz	6 dBi to 12.5 dBi
Max. wind speed	without ice deposit	180 km/h
Connector		N female
MTBF		> 100 000 h
Operating temperature range		-30°C to +50°C
Dimensions of antenna array	W x L	approx. 11 m x 8.8 m (36 ft x 29 ft)
Weight of antenna array		approx. 100 kg (221 lb)

Ordering information

Ordering information	Type	Order No.
Log-periodic HF antenna	R&S®HL471	0755.3008.02

Recommended extras

Lattice mast, length: 15 m (standard)	R&S®KM451B2	4028.3400.02
Lattice mast, length: 10 m (for roof mounting)	R&S®KM451B1	4028.3351.02
Hazard light	R&S®KM451F1	4028.3500.02
Antenna rotator	R&S®RD130	4059.8503.02
Rotary joint/adaption set	R&S®RD008Z1	0720.6400.02
Control unit	R&S®GB130	4059.8755.02
Set of cables (connecting R&S®GB130 to R&S®RD130, lengths: 50/80/120/200 m)	R&S®GK130	4059.8855.0x (x = 2/3/4/5)
Other configurations on request.		

Typical radiation patterns on a 15 m mast

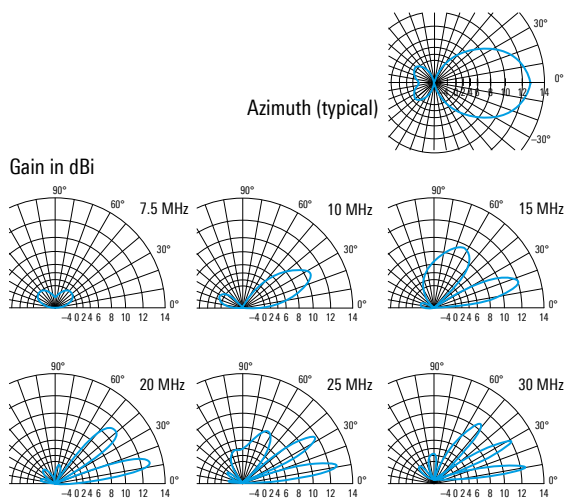

Typical directivity on a 15 m mast

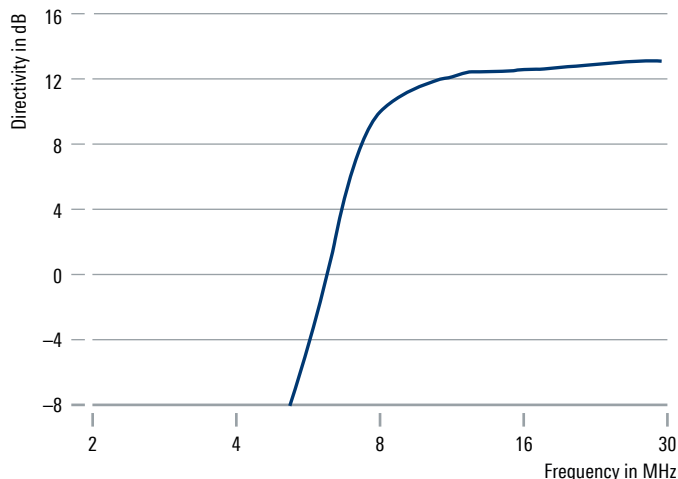

R&S®HL210A3 LOG-PERIODIC HF ANTENNA

1.5 MHz to 30 MHz

For high-sensitivity radiomonitoring through reception of ground waves and vertically polarized skywaves



The R&S®HL210A3 log-periodic HF antenna is suitable for the reception of ground waves and vertically polarized skywaves and allows even very weak signals to be detected.

According to the physical characteristics of vertically polarized waves, maximum sensitivity is obtained at low and medium elevation angles. The radiation pattern of the R&S®HL210A3 is optimally suited for this purpose. The azimuth range of the R&S®HL210A3 of about 120° can be enhanced up to 360° by adding two further antennas.

The antenna can be adapted to customer requirements regarding frequency range, environmental data and size.

For additional reception of horizontally polarized waves and high-angle radiation (predominantly horizontally polarized), the antenna can be combined with the R&S®HL410A3 log-periodic HF antenna.

Key facts

- ▶ Extremely wide frequency range
- ▶ Very high efficiency through dipole structure
- ▶ Reception of even very weak signals
- ▶ High directivity
- ▶ Small antenna size for 1.5 MHz to 30 MHz range
- ▶ No ground net required
- ▶ Low maintenance

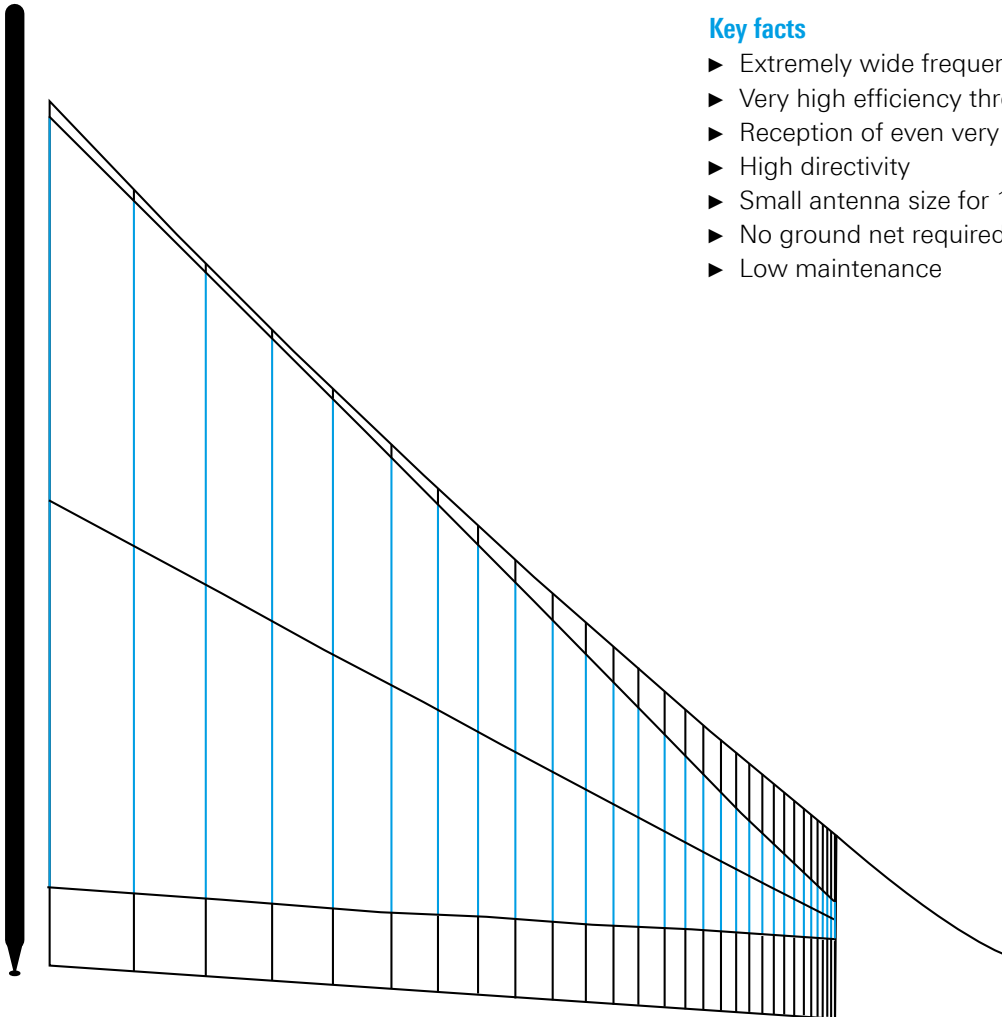

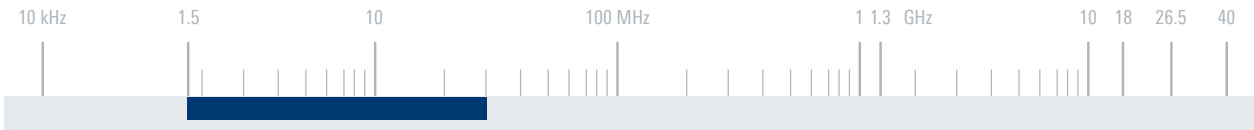

Specifications (exemplary data only)

Frequency range	1.5 MHz to 30 MHz	
Polarization	linear/vertical	
Input impedance	50 Ω	
VSWR	1.5 MHz to 2 MHz	< 6
	2 MHz to 30 MHz	< 2.5; typ. < 2.0
Directivity	1.5 MHz to 2 MHz	8 dBi to 10.5 dBi
	2 MHz to 30 MHz	10.5 dBi to 12 dBi
Efficiency	> 90%	
Connector	N female	
MTBF	≥ 100000 h	
Operating temperature range	-40°C to +70°C	
Max. wind speed	survival	225 km/h
	with ice deposit	135 km/h
	operational	130 km/h
Permissible ice deposit	20 mm radial	on wires with diameter > 7 mm
	2 × diameter	on wires with diameter < 7 mm
Dimensions	length of antenna array	approx. 97 m (318 ft)
	height of supporting mast	approx. 90 m (295 ft)

Ordering information	Type	Order No.
Log-periodic HF antenna	R&S®HL210A3	on request

Typical vertical and horizontal radiation patterns (only half of the horizontal radiation pattern displayed)

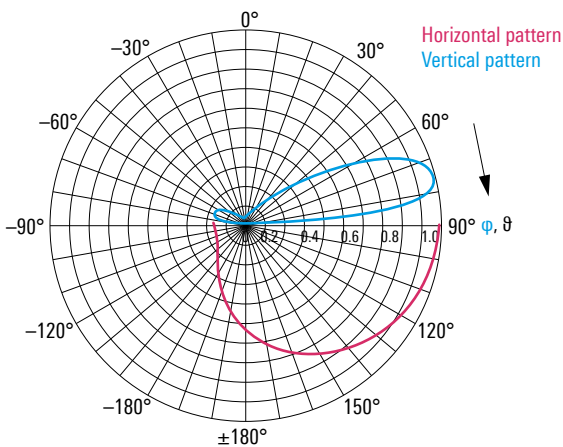

Typical horizontal reception characteristic of a system with three R&S®HL210A3

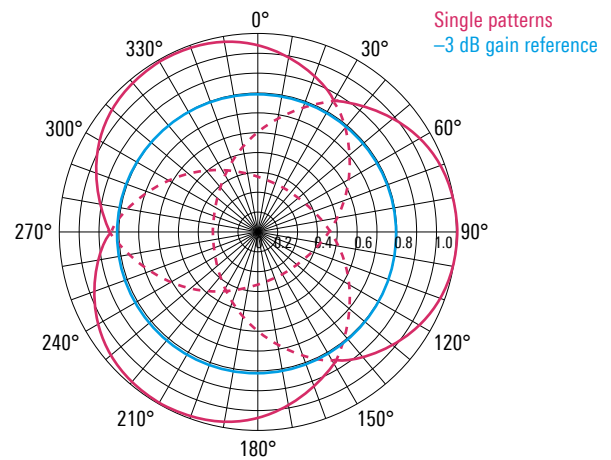

R&S®HL410A3 LOG-PERIODIC HF ANTENNA

1.5 MHz to 30 MHz

For extremely high sensitivity radiomonitoring over short, medium and global distances



The R&S®HL410A3 log-periodic HF antenna is suitable for the reception of horizontally polarized waves and allows even very weak signals to be detected.

The vertical pattern is shaped taking into account the transmission characteristics in the ionosphere. In conjunction with the extremely wide frequency range from 1.5 MHz to 30 MHz, the antenna allows reception over short, medium and global distances.

The antenna can be adapted to customer requirements regarding frequency range, vertical pattern, environmental data and size.

The half-power beamwidth of the horizontal radiation pattern of about 70° can be enhanced up to 360° by adding five further antennas. For the reception of vertically polarized waves, the antenna can be combined with the R&S®HL210A3 log-periodic HF antenna.

Key facts

- ▶ Extremely wide frequency range
- ▶ Very high efficiency through dipole structure
- ▶ Reception of even very weak signals
- ▶ High directivity
- ▶ No skip zone
- ▶ Small antenna size for 1.5 MHz to 30 MHz range
- ▶ Low maintenance

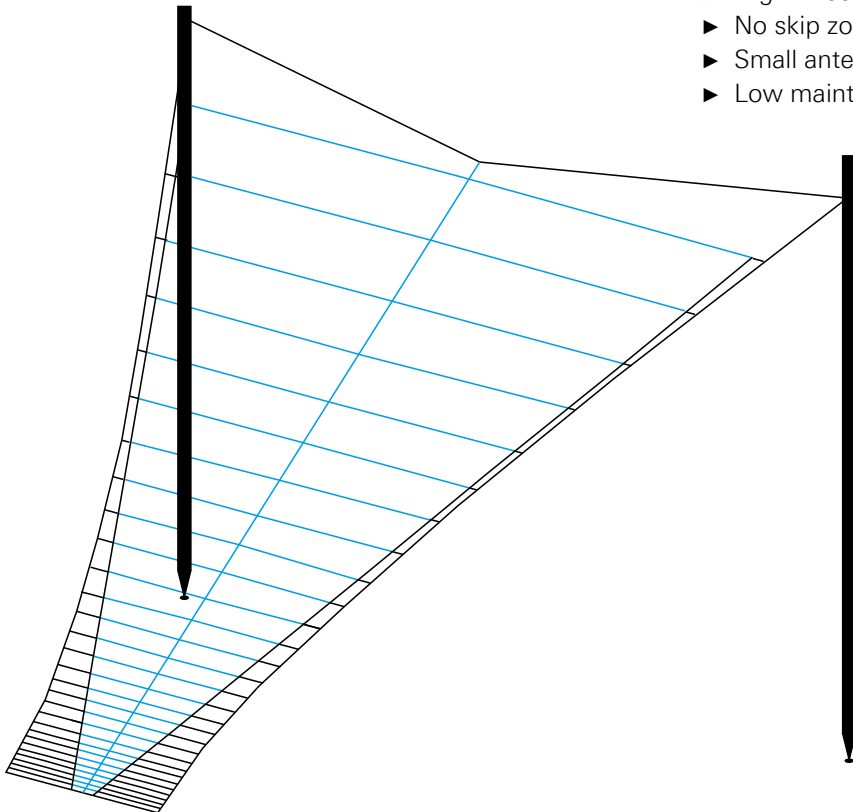

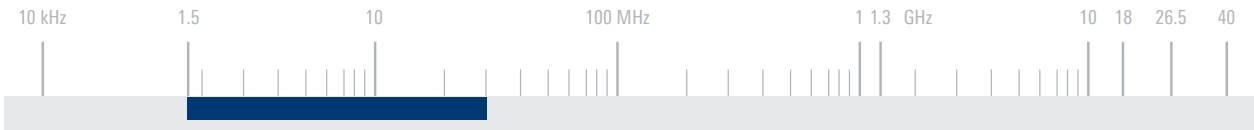

Specifications (exemplary data only)

Frequency range	1.5 MHz to 30 MHz	
Polarization	linear/horizontal	
Input impedance	50 Ω	
VSWR	1.5 MHz	< 6
	2 MHz to 30 MHz	< 2.5; typ. < 2.0
Directivity	at 1.5 MHz	7.5 dBi
	1.6 MHz to 30 MHz	8 dBi to 12 dBi
Efficiency	> 90%	
Connector	N female	
MTBF	≥ 100000 h	
Operating temperature range	-40°C to +70°C	
Max. wind speed	survival	225 km/h
	with ice deposit	135 km/h
	operational	130 km/h
Permissible ice deposit	20 mm radial	on wires with diameter > 7 mm
	2 × diameter	on wires with diameter < 7 mm
Dimensions of antenna array	W × L	approx. 88 m × 94 m (289 ft × 308 ft)
	height of supporting mast	approx. 66 m (217 ft)

Ordering information	Type	Order No.
Log-periodic HF antenna	R&S®HL410A3	on request

Typical vertical and horizontal radiation patterns (only half of the horizontal radiation pattern displayed)

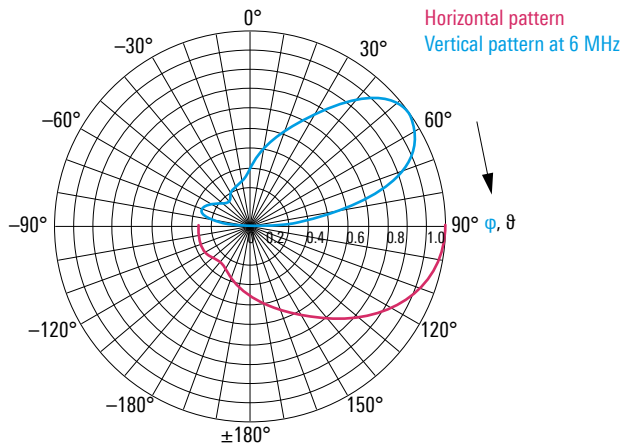

Typical horizontal reception characteristic of a system with six R&S®HL410A3

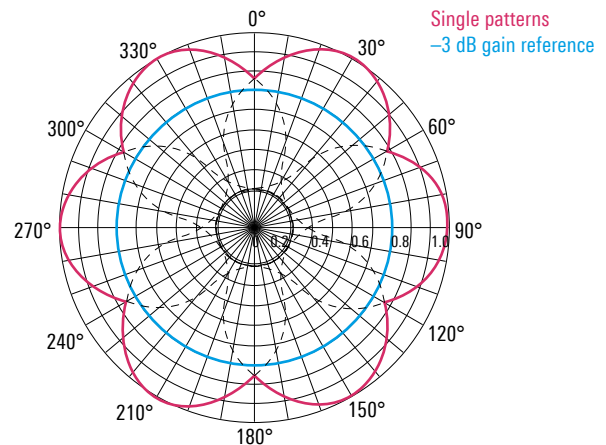

R&S®HFH2-Z2E ACTIVE LOOP ANTENNA

8.3 kHz to 30 MHz

Broadband active loop antenna for measuring magnetic field-strength components



The R&S®HFH2-Z2E active loop antenna measures the magnetic field strength in the LF, MF and HF range. It can be used for EMI measurements in line with various standards (i.e. CISPR, MIL, FCC, ANSI, ETSI).

Each antenna is individually calibrated.

It is characterized by an almost frequency-independent antenna factor and very high sensitivity.

In strong field environments, an attenuator can be activated to reduce distortion. An integrated RF detector with a threshold circuit reports overload of the antenna.

The antenna is supplied via a coaxial cable using the optional R&S®IN600 bias unit.

Key facts

- ▶ Wide frequency range
- ▶ High sensitivity
- ▶ Wide dynamic range
- ▶ Compact design
- ▶ Integrated overload warning
- ▶ R&S®IN600 bias unit for power supply via coaxial cable available
- ▶ No batteries needed
- ▶ Individual calibration certificate supplied with antenna
- ▶ Virtually constant antenna factor



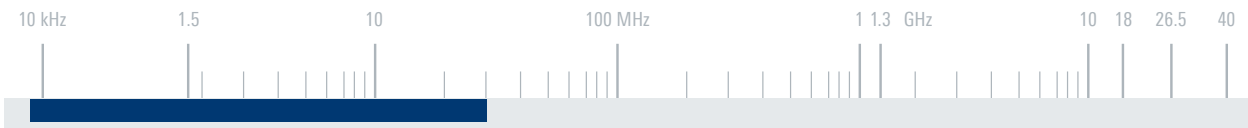

Specifications		
Frequency range		8.3 kHz to 30 MHz
Polarization		linear
Nominal impedance		50 Ω
VSWR	8.3 kHz to 20 kHz	< 1.8
	> 20 kHz to 30 MHz	< 1.6
Antenna connector		N female
Antenna factor		
Normal mode	8.3 kHz to 20 kHz	20 dB (1/m) ± 2 dB
	> 20 kHz to 30 MHz	20 dB (1/m) ± 1.5 dB
Attenuation mode	8.3 kHz to 20 kHz	30 dB (1/m) ± 2 dB
	> 20 kHz to 30 MHz	30 dB (1/m) ± 1.5 dB
Lower limit magnetic field strength in normal mode	8.3 kHz to 1.5 MHz	see diagram
	> 1.5 MHz to 30 MHz	< -70 dB(μA/m/Hz) (meas.)
Upper limit magnetic field strength	normal mode	typ. 85 dB(μA/m)
	attenuation mode	typ. 95 dB(μA/m)
Destructive field strength	8.3 kHz to 30 MHz	> 30 V/m
	> 30 MHz to 2 GHz	> 10 V/m
	MTBF	> 100000 h
Power supply (via coaxial cable)		+24 V DC -3 V/+1 V (max. 150 mA)
Operating temperature range		+5°C to +40°C
Dimensions	W × D × H	approx. 596 mm × 90 mm × 822 mm (24 in × 4 in × 32 in)
	loop diameter	approx. 600 mm (24 in)
Weight		approx. 3 kg (7 lb)

Ordering information	Type	Order No.
Active loop antenna	R&S®HFH2-Z2E	4110.2002.02
Recommended extras		
Bias unit	R&S®IN600	4094.3004.13
Transport case	R&S®HFH2-Z7	4110.2925.02
Tripod	R&S®HFH2-Z8	4110.2902.02
3D adapter for X, Y, Z plane measurements on R&S®HFH2-Z8	R&S®HFH2-Z9	4110.2919.02
Height adaptation set	R&S®HFH2-Z11	4110.2948.02

Lower limit field strength level (for SNR = 1) in normal mode (meas.)

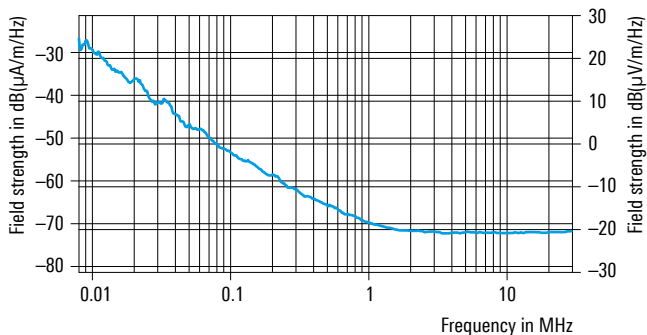

R&S®HFH2-Z6E ACTIVE ROD ANTENNA

8.3 kHz to 30 MHz

Broadband active rod antenna for measuring electrical field components in EMI test setups



The R&S®HFH2-Z6E active rod antenna measures the electrical field strength in the LF, MF and HF range. It can be used for EMI measurements in line with various standards (i.e. CISPR, MIL, FCC, ANSI, ETSI).

Individual calibration in line with CISPR/ANSI standards available.

It is characterized by an almost frequency-independent antenna factor and very high sensitivity.

In strong field environments, an attenuator can be activated to reduce distortion. An integrated RF detector with a threshold circuit reports overload of the antenna.

The antenna is supplied via a coaxial cable using the optional R&S®IN600 bias unit.

Key facts

- ▶ Wide frequency range
- ▶ High sensitivity
- ▶ Wide dynamic range
- ▶ Compact design
- ▶ Integrated overload warning
- ▶ R&S®IN600 bias unit for power supply via coaxial cable available
- ▶ No batteries needed
- ▶ Individual calibration certificate supplied with antenna
- ▶ Virtually constant antenna factor



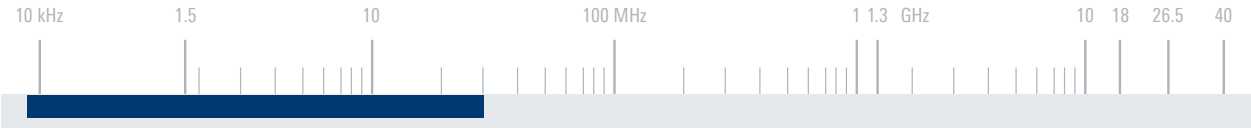

Specifications		
Frequency range		8.3 kHz to 30 MHz
Polarization		linear/vertical
Nominal impedance		50 Ω
VSWR		< 1.6
RF connector		N female
Antenna factor in		
Normal mode	8.3 kHz to 20 kHz	10 dB(1/m) ± 2 dB
	> 20 kHz to 30 MHz	10 dB(1/m) ± 1.5 dB
Attenuation mode	8.3 kHz to 20 kHz	20 dB(1/m) ± 2 dB
	> 20 kHz to 30 MHz	20 dB(1/m) ± 1.5 dB
Lower limit field strength in normal mode		
	8.3 kHz to 1 MHz	see diagram
	> 1 MHz to 30 MHz	< -40 dB(μV/m/Hz) (meas.)
Upper limit field strength	normal mode	typ. 125 dB(μV/m)
	attenuation mode	typ. 135 dB(μV/m)
Destructive field strength	8.3 kHz to 30 MHz	> 50 V/m
	> 30 MHz to 2 GHz	> 10 V/m
MTBF		> 100000 h
Power supply (via coaxial cable)		+24 V DC -3 V/+1 V (max. 150 mA)
Operating temperature range		+5°C to +40°C
Dimensions	base (W × L × H)	approx. 600 mm × 600 mm × 100 mm (24 in × 24 in × 4 in)
	rod height	approx. 1000 mm (39 in)/1040 mm (41 in)
Weight		approx. 6.5 kg (14 lb)

Ordering information	Type	Order No.
Active rod antenna	R&S®HFH2-Z6E	4110.1006.02
Recommended extras		
Calibration adapter	R&S®HFH2-Z10	4110.1570.02
Bias unit	R&S®IN600	4094.3004.13
Wooden tripod	R&S®HZ-1	0837.2310.02
Rod antenna stand	R&S®RAS	5611.5035.02

Lower limit field strength level (for SNR = 1) in normal mode (meas.)

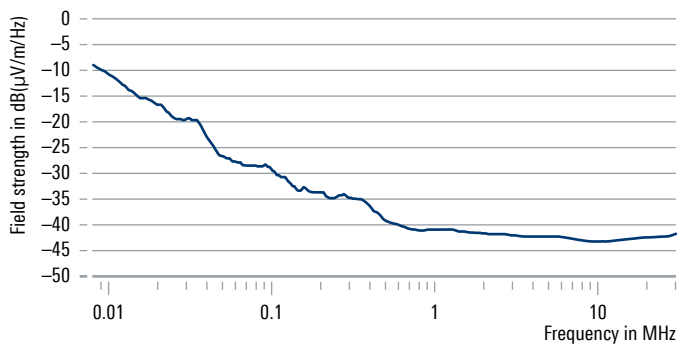

CHAPTER 2

VHF/UHF ANTENNAS

Type	Designation	Page
R&S°AM524 Update	Low-noise active antenna system	62
R&S°HF214	Omnidirectional antenna	64
R&S°HF902	Omnidirectional antenna	66
R&S°HK309	Passive receiving dipole	68
R&S°HE309E	Active vertical dipole	70
R&S°HE302 Update	Active receiving dipole	72
R&S°HE202 Update	Active receiving dipole	74
R&S°HE314A1	Active omnidirectional antenna	76
R&S°HE400 Update	Handheld directional antenna	78
R&S°HE400DC New	Handheld directional antenna with downconverter	80
R&S°HE400MW New	Microwave handheld directional antenna	82
R&S°HE400BC New	Basic handheld directional antenna	84
R&S°HE500	Active receiving antenna	86
R&S°HE600	Active omnidirectional receiving antenna	88
R&S°HK116E	Biconical antenna	90
R&S°HL007A2	Crossed log-periodic antenna	92
R&S°HL033	Log-periodic broadband antenna	94
R&S°HL040E	Log-periodic broadband antenna	96
R&S°HL047 New	High gain log-periodic antenna	98
R&S°HL223	Log-periodic antenna	100
R&S°HL562E	ULTRALOG	102
R&S°AD033V3	Omnidirectional UHF antenna	104
R&S°AD066FW	Broadband VHF/UHF communications antenna system	106
R&S°AD066ST	Omnidirectional UHF antenna	108
R&S°HK001E	UHF coaxial dipole	110
R&S°HK012E	VHF coaxial dipole	112
R&S°HK014E	VHF/UHF coaxial dipole	114
R&S°HK033	VHF/UHF coaxial dipole	116
R&S°HK055S1	Omnidirectional broadband antenna	118
R&S°HK055L1	Broadband mobile antenna	120
R&S°HK056	Broadband mobile antenna	122
R&S°HK060	Broadband manpack antenna	124
R&S°HK061	Vehicular broadband communications antenna	126
R&S°AU600	Active omnidirectional receiving antenna system	128

R&S®AM524 LOW-NOISE ACTIVE ANTENNA SYSTEM

100 Hz to 1 GHz; optional 26.5 GHz

For measuring low-level signals in anechoic chambers

Update



The R&S®AM524 low-noise active antenna system has been designed for measuring low-level signals in anechoic chambers. Criteria for dimensioning such antennas are different from those of active antennas used outside shielded rooms.

The R&S®AM524 features maximum sensitivity, small dimensions and the capacity to handle large signal emissions from the EUT.

Individual calibration in line with ANSI standards available.

Key facts

- ▶ Extremely high sensitivity
- ▶ Excellent large-signal characteristics
- ▶ Wide frequency range
- ▶ Especially suitable for TEMPEST measurements

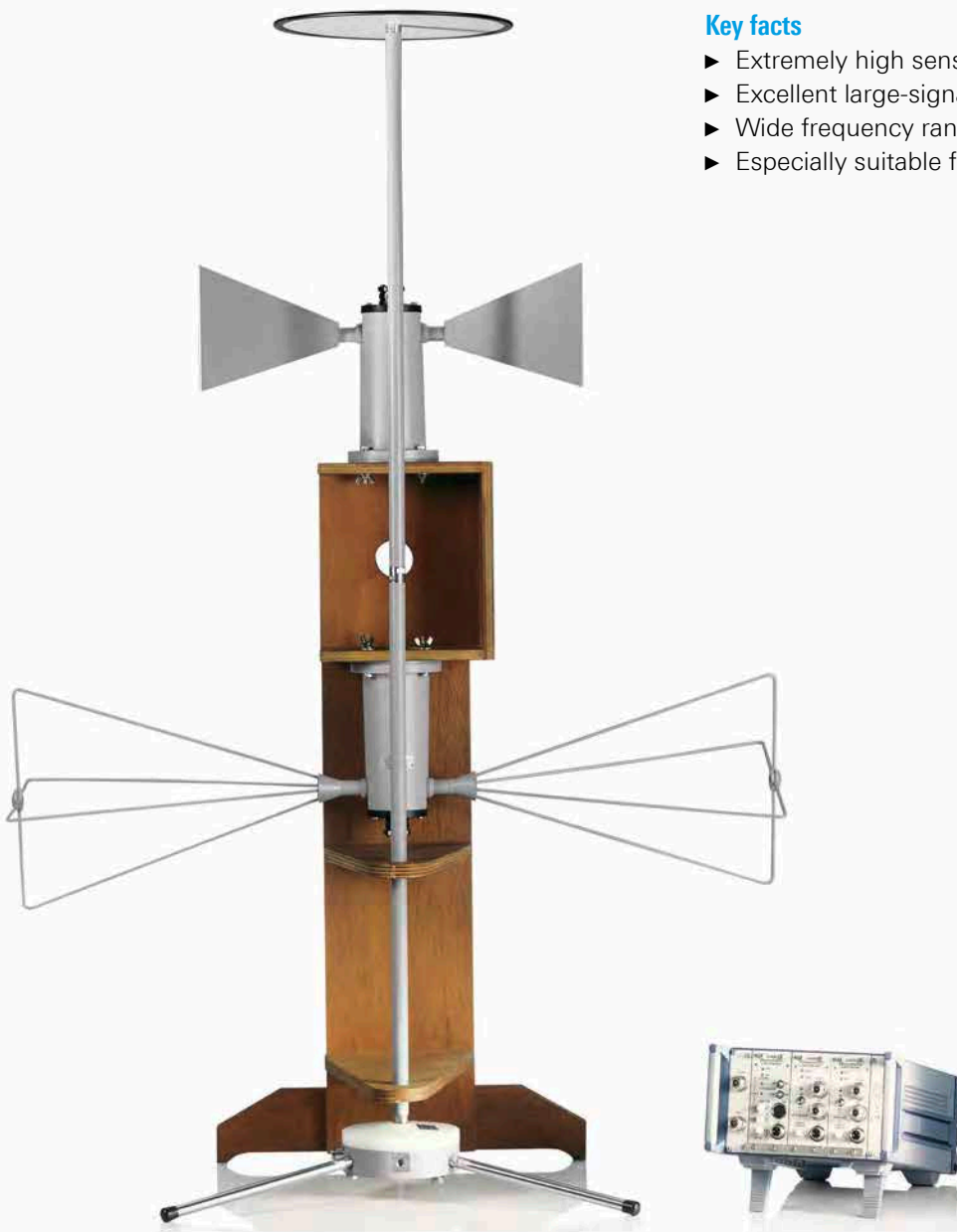



Specifications

Frequency range	100 Hz to 1 GHz (in three subranges)	
	850 MHz to 26.5 GHz (optional with R&S®HL050S7)	
Input impedance	50 Ω	
Antenna factor ¹⁾	100 Hz to 30 MHz	-2 dB/m to 0 dB/m
	100 MHz	-10 dB/m to -4 dB/m
	1 GHz	-5 dB/m to 19 dB/m
Field strength sensitivity (Δf = 1 Hz, S/N = 0 dB)	100 Hz	0 dB(μV/m) (typ.)
	100 kHz	-43 dB(μV/m) (typ.)
	30 MHz	-51 dB(μV/m) (typ.)
	100 MHz	-54 dB(μV/m) (typ.)
	1 GHz	-37 dB(μV/m) (typ.)
Power supply	AC	100/120/220/230/240 V ± 10%, 47 Hz to 63 Hz
	DC	22 V to 28 V, max. 0.7 A
Connectors	N female	
MTBF	> 15000 h	
Operating temperature range	-10°C to +55°C	
Dimensions (W × H)	R&S®HE525	approx. 0.3 m × 1.5 m (11.8 in × 59.1 in)
	R&S®HE526	approx. 1 m × 0.3 m (39.4 in × 11.8 in)
	R&S®HE527	approx. 0.5 m × 0.25 m (19.7 in × 9.9 in)
Weight	R&S®HE525	approx. 5 kg (11.0 lb)
	R&S®HE526	approx. 1.7 kg (3.8 lb)
	R&S®HE527	approx. 1.6 kg (3.5 lb)

¹⁾ Without attenuator or amplifier.

Ordering information	Type	Order No.
Low-noise active antenna system	R&S®AM524	4015.7001.02
Recommended extras		
Open switch and control platform without touchscreen	R&S®OSP-220	1528.3105.02
Open switch and control platform with touchscreen	R&S®OSP-230	1528.3105.03
Module for R&S®OSP, for controlling R&S®AM524	R&S®OSP-BS524	4118.6007.02
Log-periodic directional antenna with preamplifier	R&S®HL050S7	4064.6040.02

Overview of system components

Shielded room

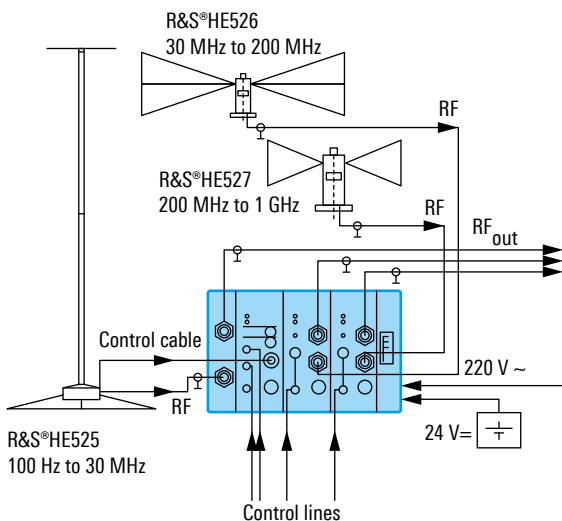

Typical field strength sensitivity

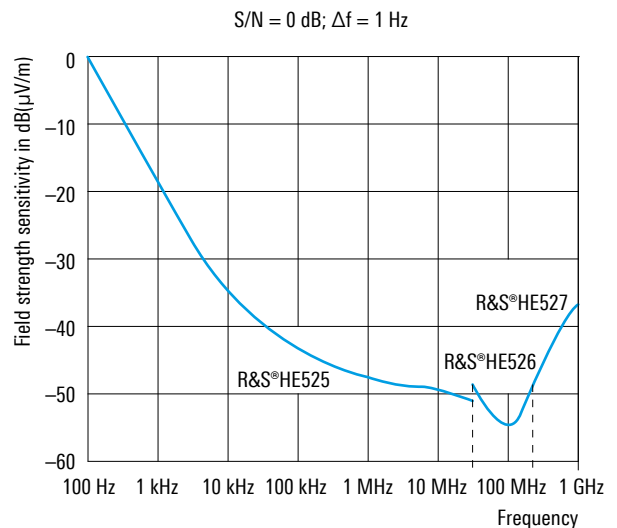

R&S®HF214 OMNIDIRECTIONAL ANTENNA

500 MHz to 1.3 GHz

Reception of horizontally polarized waves



The R&S®HF214 omnidirectional antenna has been designed for the reception of horizontally polarized waves. It is ideal for broadband detection and monitoring of RF signals in the frequency range from 500 MHz to 1.3 GHz.

With a diameter of only 0.31 m and a height of 0.49 m, the compact broadband antenna is particularly suitable for applications where the available space is limited.

A compact omnidirectional receiving system for horizontally and vertically polarized waves in the frequency range from 20 MHz to 3 GHz is obtained by combining the R&S®HF214 with the R&S®HE309E, R&S®HE314A1 and R&S®HF902 antennas.

Key facts

- ▶ Broadband frequency range
- ▶ Easy integration into broadband antenna systems due to cable feedthrough
- ▶ Small size
- ▶ Rugged design
- ▶ Suitable for mobile use
- ▶ Ideal for detection and monitoring of horizontally polarized signals



Antenna without radome

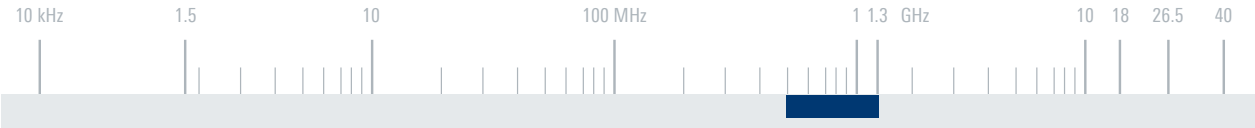

Specifications

Frequency range	500 MHz to 1.3 GHz	
Polarization	linear/horizontal	
Input impedance	50 Ω	
VSWR	typ. < 3	
Gain	see diagram	
Uncircularity of horizontal radiation pattern	±3 dB	
Connector	N female	
MTBF	> 50 000 h	
Operating temperature range	-40°C to +65°C	
Protection class	IP55	
Max. wind speed	without ice deposit	188 km/h
	with 30 mm radial ice deposit	130 km/h
Dimensions	Ø × H	approx. 310 mm × 490 mm (12 in × 19 in)
Weight	approx. 10 kg (22 lb)	

Ordering information

Ordering information	Type	Order No.
Omnidirectional antenna	R&S®HF214	4042.7009.02

Recommended extras

Active vertical dipole	R&S®HE309E	4098.0000.02
Active omnidirectional antenna	R&S®HE314A1	4027.6505.02
Omnidirectional antenna	R&S®HF902	4042.8005.02

Typical gain

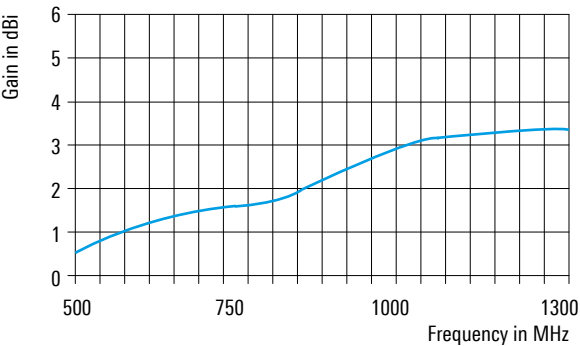

Typical VSWR

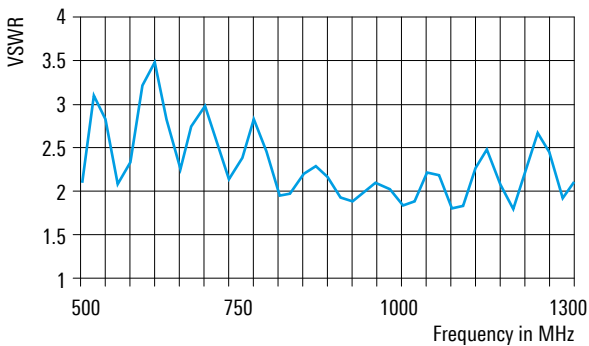

R&S®HF902 OMNIDIRECTIONAL ANTENNA

1 GHz to 3 GHz

Reception of vertically and horizontally polarized waves



The R&S®HF902 omnidirectional antenna has been designed for the reception of vertically and horizontally polarized waves. It is ideal for broadband detection and monitoring of RF signals in the frequency range from 1 GHz to 3 GHz.

With a diameter of only 0.31 m and a height of 0.49 m, the compact broadband antenna is particularly suitable for applications where the available space is limited.

A compact omnidirectional receiving system for horizontally and vertically polarized waves in the frequency range from 20 MHz to 3 GHz is obtained when combining the R&S®HF902 with the R&S®HE309E, R&S®HE314A1 and R&S®HF214 antennas.

Key facts

- ▶ Broadband frequency range
- ▶ Easy integration into broadband antenna systems due to cable feedthrough
- ▶ Compact
- ▶ Rugged design
- ▶ Suitable for mobile use
- ▶ Ideal for detection and monitoring of horizontally and vertically polarized signals

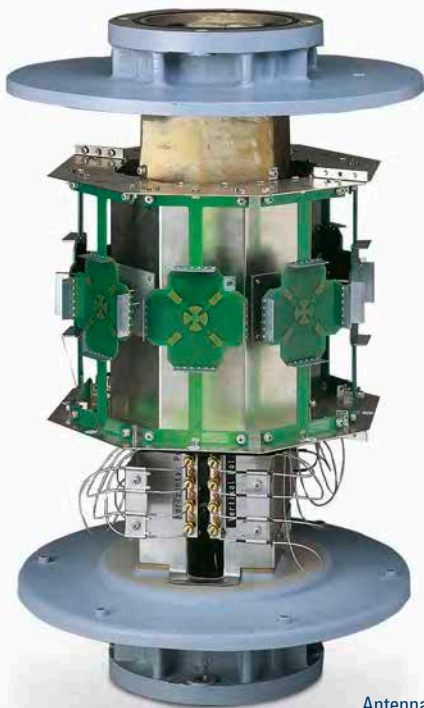

Antenna without radome

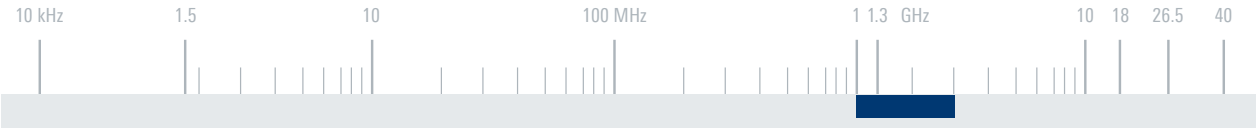

Specifications

Frequency range		1 GHz to 3 GHz
Polarization		linear/horizontal and vertical
Input impedance		50 Ω
VSWR		see diagram
Gain		see diagram
Connector		2 × N female
MTBF		> 50 000 h
Operating temperature range		-40°C to +65°C
Protection class		IP55
Max. wind speed	without ice deposit	188 km/h
	with 30 mm radial ice deposit	130 km/h
Dimensions	Ø × H	approx. 310 mm × 490 mm (12 in × 19 in)
Weight		approx. 10 kg (22 lb)

Ordering information	Type	Order No.
Omnidirectional antenna	R&S®HF902	4042.8005.02

Recommended extras		
Active vertical dipole	R&S®HE309E	4098.0000.02
Active omnidirectional antenna	R&S®HE314A1	4027.6505.02
Omnidirectional antenna	R&S®HF214	4042.7009.02

Typical gain

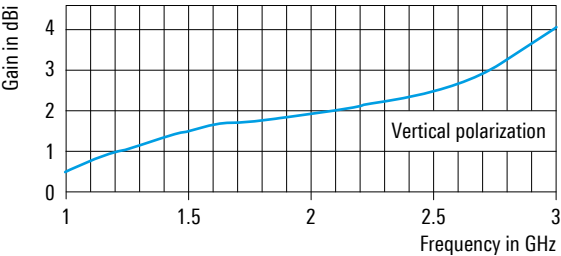
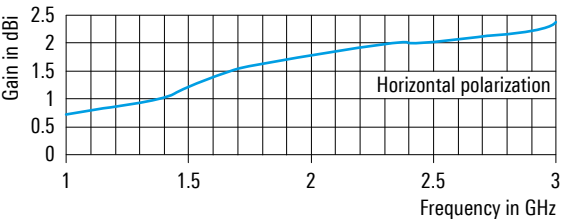

Typical VSWR

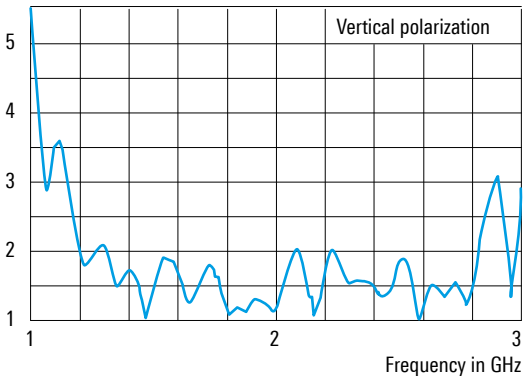
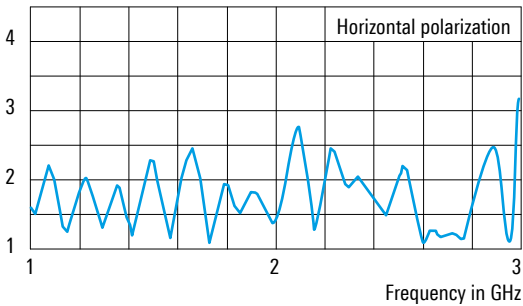

R&S®HK309 PASSIVE RECEIVING DIPOLE

20 MHz to 1.3 GHz

Passive broadband receiving dipole for vertically polarized signals and high field strengths



Its extremely wide bandwidth and high sensitivity make the R&S®HK309 particularly suitable for reception tasks in communications, reconnaissance and measurement.

Compact design, a minimum number of distribution and switching units and a high S/N ratio are essential features for these applications.

The broadband characteristic of the R&S®HK309 passive receiving dipole is ensured by eight impedance elements which suppress nulls in the main direction of reception.

Key facts

- ▶ Extremely wide frequency range
- ▶ High sensitivity
- ▶ High large-signal immunity
- ▶ High protection against lightning strikes in the vicinity
- ▶ Small size (dipole length only 1.7 m)
- ▶ Low weight

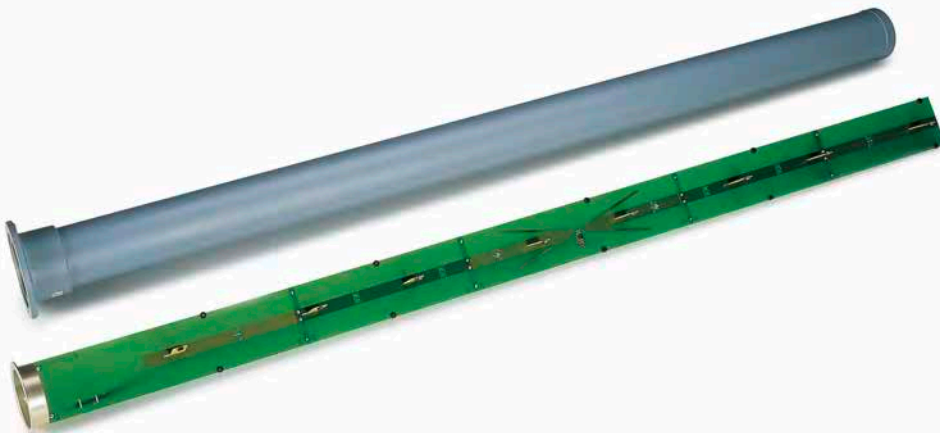

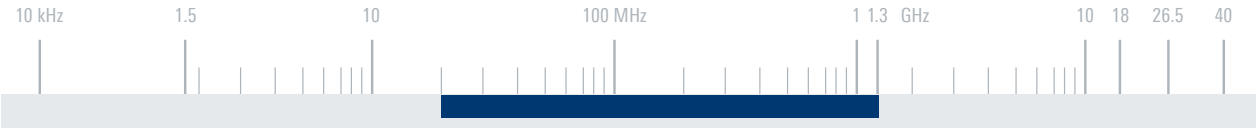

Specifications

Frequency range	20 MHz to 1.3 GHz	
Polarization	linear/vertical	
Horizontal radiation pattern	omnidirectional	
Input impedance	50 Ω	
VSWR	typ. < 3	
Gain	-24 dBi to -2 dBi (typ.)	
Connector	N female	
Operating temperature range	-40°C to +70°C	
Max. wind speed	without ice deposit	180 km/h
MTBF	> 100000 h	
Dimensions	Ø × L	approx. 100 mm × 1710 mm (4 in × 67 in)
Weight	approx. 4 kg (9 lb)	

Ordering information	Type	Order No.
Passive receiving dipole	R&S®HK309	4054.2007.02

Typical gain

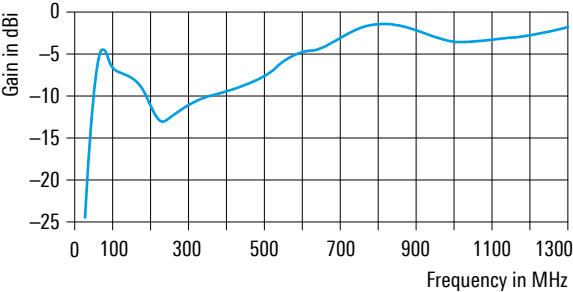

Typical VSWR

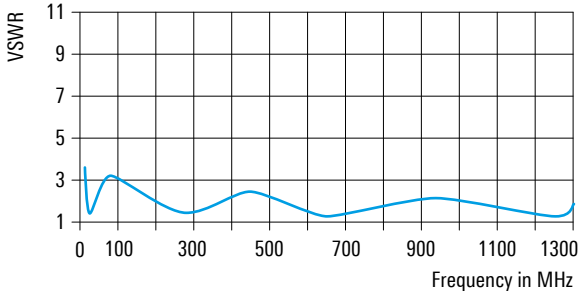

R&S®HE309E ACTIVE VERTICAL DIPOLE

20 MHz to 1.3 GHz

High sensitivity, large bandwidth and wide dynamic range



The R&S®HE309E active vertical dipole is designed to receive vertically polarized signals in the frequency range from 20 MHz to 1.3 GHz.

The lightweight and compact antenna is accommodated in a weatherproof and rugged fiberglass-reinforced plastic (GRP) radome that fully protects the receiving dipole against the effects of weathering.

Characterized by its small dimensions, it is ideal for use in mobile systems and provides optimum reception results even if space is limited.

A large bandwidth, wide dynamic range and excellent field strength sensitivity make the R&S®HE309E suitable for all receiving tasks that might occur in the field of communications, radiomonitoring and radiolocation.

Key facts

- ▶ Extremely wide frequency range
- ▶ High sensitivity (low inherent noise)
- ▶ High linearity and spurious-free dynamic range
- ▶ Compact dimensions
- ▶ Rugged and weatherproof design
- ▶ No deterioration of the radiation pattern due to divided dipole design



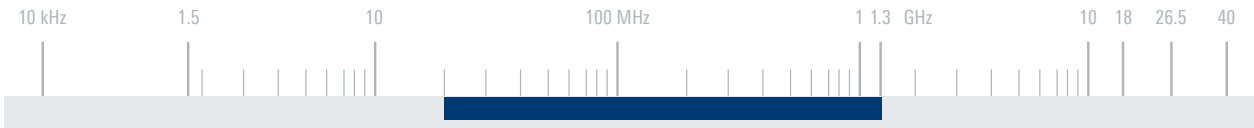

Specifications

Frequency range		20 MHz to 1.3 GHz
Polarization		linear vertical
Input impedance		50 Ω
VSWR		< 3.0; typ. 2.5
Circularity of horizontal pattern		typ. 3 dB
IP2		typ. 60 dBm
IP3		typ. 30 dBm
Power supply		24 V DC (-3 V/+1 V) (max. 350 mA)
RF connector		N female
MTBF		> 100 000 h
Operating temperature range		-40°C to +70°C
Storage temperature range		-40°C to +85°C
Protection class		IPx5, in line with EN 60259
Max. wind speed	without ice deposit	200 km/h
	with 30 mm ice deposit	180 km/h
Dimensions	Ø × L	approx. 1.21 m × 0.16 m (48 in × 5 in)
Weight		approx. 3 kg (7 lb)

Ordering information

Ordering information	Type	Order No.
Active vertical dipole	R&S®HE309E	
Color: squirrel gray (RAL 7000)		4098.0000.02
Color: bronze green (RAL 6031)		4098.0000.03
Color: light ivory (RAL 1015)		4098.0000.04
Recommended extra		
Bias unit	R&S®IN600	4094.3004.xx

Typical field strength sensitivity at antenna output (bandwidth = 1 Hz, SNR = 0 dB)

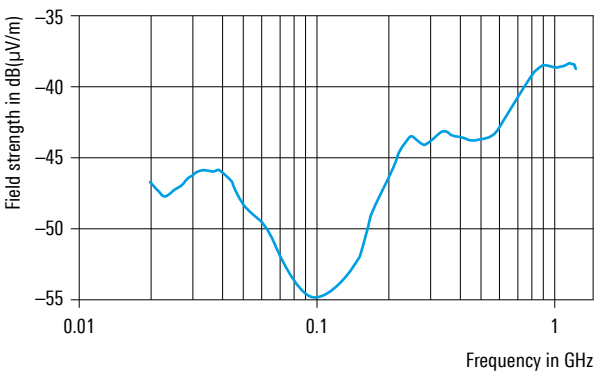

Typical field patterns in the E plane

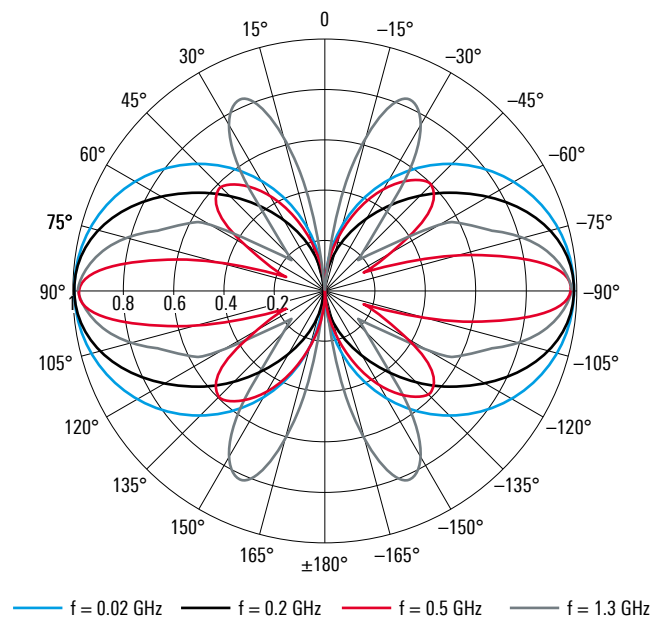

R&S®HE302 ACTIVE RECEIVING DIPOLE

20 MHz to 500 MHz

Optimized for high sensitivity and small size

Update



The R&S®HE302 active receiving dipole features a very wide frequency range and small size. Its high input sensitivity is the result of optimized matching of the passive antenna structure to the active circuitry.

These characteristics allow several passive antennas to be replaced by an R&S®HE302.

Similar to a passive antenna with high-grade preamplifiers, the active antenna is highly insensitive to nonlinear distortion.

Individual calibration in line with CISPR/ANSI standards available.

Key facts

- ▶ Wide frequency range
- ▶ High immunity to nonlinear distortion
- ▶ High immunity to lightning strikes in the vicinity
- ▶ Low weight
- ▶ Extremely compact
- ▶ Shock- and vibration-proof



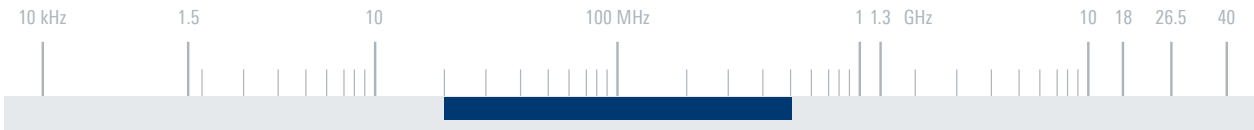

Specifications

Frequency range		20 MHz to 500 MHz
Polarization		linear
Input impedance		50 Ω
VSWR		< 2.5
Electronic gain		-11 dB to +8 dB
Realized gain		-9 dB to +10 dB
Directivity		2 dB (average)
Antenna factor		0 dB/m to 14 dB/m
Noise figure	20 MHz	28 dB
	500 MHz	9 dB
Field strength sensitivity (Δf = 1 kHz; S/N: 0 dB (typ.))	20 MHz	-15 dB(μV/m)
	500 MHz	-6 dB(μV/m)
IP2		> 60 dBm
IP3		> 30 dBm
Power supply		18 V to 30 V DC (170 mA (typ.))
Connector		N female
MTBF		> 50 000 h
Operating temperature range		-40°C to +75°C
Max. wind speed	without ice deposit	180 km/h
Dimensions	L × H	approx. 1 m × 240 mm (39.4 in × 9.5 in)
Weight		approx. 2.5 kg (5.5 lb)

Ordering information

Ordering information	Type	Order No.
Active receiving dipole	R&S®HE302	0644.1114.02
Active receiving dipole, calibrated	R&S®HE302	0644.1114.03

Recommended extra

Bias unit	R&S®IN600	4094.3004.xx
-----------	-----------	--------------

Typical realized gain

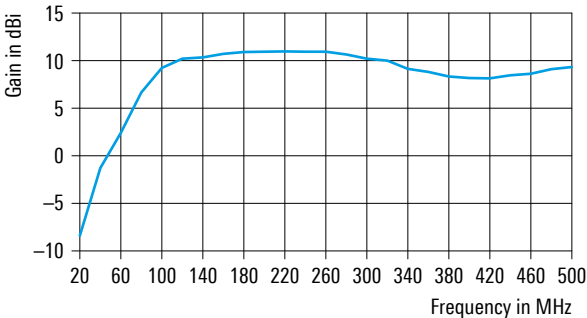

Typical radiation pattern in the E plane at 200 MHz

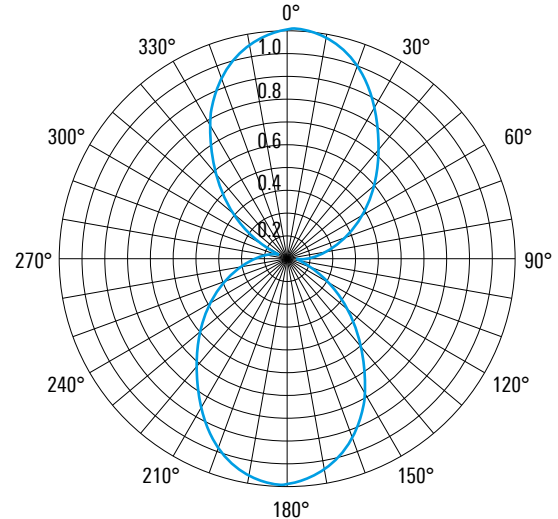

R&S®HE202 ACTIVE RECEIVING DIPOLE

200 MHz to 1 GHz

Optimized for high sensitivity and small size

Update



The R&S®HE202 active receiving dipole features a very wide frequency range and small size. Its high input sensitivity is the result of optimized matching of the passive antenna structure to the active circuitry.

These characteristics allow several passive antennas to be replaced by an R&S®HE202.

Similar to a passive antenna with high-grade preamplifiers, the active antenna is highly insensitive to nonlinear distortion.

Individual calibration in line with CISPR standards available.

Key facts

- ▶ Wide frequency range
- ▶ High immunity to nonlinear distortion
- ▶ High immunity to lightning strikes in the vicinity
- ▶ Low weight
- ▶ Extremely compact
- ▶ Shock- and vibration-proof



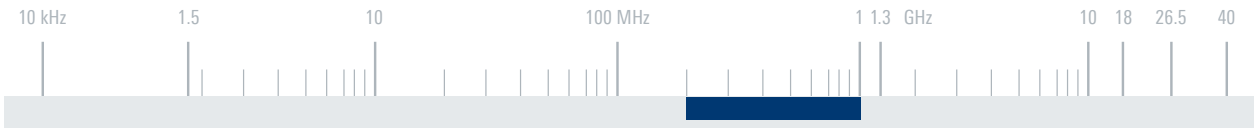

Specifications

Frequency range		200 MHz to 1 GHz
Polarization		linear
Input impedance		50 Ω
VSWR		< 2.5 (typ.)
Electronic gain		5 dB to 9 dB
Realized gain		7 dB to 11 dB
Directivity		2 dB (average)
Antenna factor		10 dB/m to 22 dB/m
Noise figure	200 MHz	6 dB
	2 GHz	7 dB
Field strength sensitivity ($\Delta f = 1$ kHz; S/N: 0 dB (typ.))	200 MHz	-17 dB(μ V/m)
	2 GHz	-2 dB(μ V/m)
IP2		> 55 dBm
IP3		> 30 dBm
Power supply		18 V to 30 V DC (max. 200 mA)
Connector		N female
MTBF		> 50 000 h
Operating temperature range		-40°C to +75°C
Max. wind speed	without ice deposit	180 km/h
Dimensions	L x H	approx. 510 mm x 240 mm (20.1 in x 9.5 in)
Weight		approx. 2.1 kg (4.6 lb)

Ordering information

Ordering information	Type	Order No.
Active receiving dipole	R&S®HE202	0630.0310.02
Active receiving dipole, calibrated	R&S®HE202	0630.0310.03

Recommended extra

Bias unit	R&S®IN600	4094.3004.xx
-----------	-----------	--------------

Typical realized gain

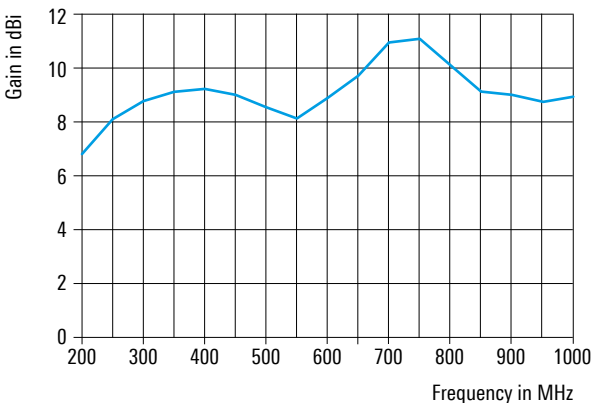

Typical radiation pattern in the E plane at 500 MHz

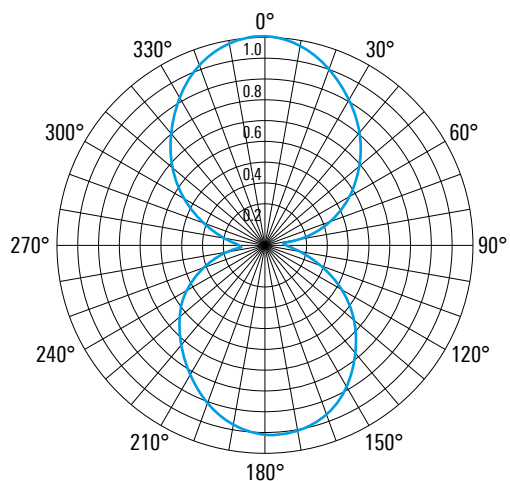

R&S®HE314A1

ACTIVE

OMNIDIRECTIONAL

ANTENNA

20 MHz to 500 MHz

Active omnidirectional reception of horizontally polarized waves



The R&S®HE314A1 is a turnstile antenna consisting of two active receiving dipoles connected via a 90° hybrid coupler.

The antenna is used for the reception of horizontally polarized signals; the horizontal radiation pattern is optimized for omnidirectional reception.

The R&S®HE314A1 can be extended for omnidirectional reception of vertically polarized waves by using, for example, an R&S®HE309E active vertical dipole mounted at the top.

Key facts

- ▶ High sensitivity
- ▶ Wide frequency range
- ▶ Omnidirectional reception of horizontally polarized waves
- ▶ Small size
- ▶ Ideal for mobile or semi-mobile receiving systems



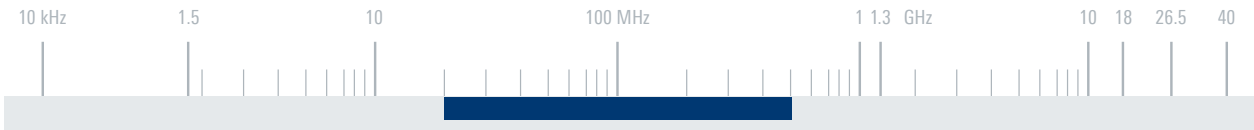

Specifications

Frequency range	20 MHz to 500 MHz	
Polarization	at horizon	linear horizontal
	at 90° elevation	right-hand circular
Input impedance	50 Ω	
VSWR	< 2.5	
Realized gain	-14 dB to +5 dB	
Antenna factor	2 dB (1/m) to 20 dB (1/m) (see diagram)	
Field strength sensitivity ($\Delta f = 1$ Hz; S/N: 0 dB)	20 MHz	-42 dB(μ V/m)
	500 MHz	-33 dB(μ V/m)
IP2	> 60 dBm	
IP3	> 30 dBm	
Power supply	18 V to 30 V DC (typ. 340 mA)	
Connector	N female	
MTBF	> 25000 h	
Operating temperature range	-40°C to +70°C	
Max. wind speed	without ice deposit	180 km/h
Dimensions	W x H x L	approx. 1 m x 0.33 m x 1 m (39 in x 13 in x 39 in)
Weight	approx. 8 kg (18 lb)	

Ordering information

Ordering information	Type	Order No.
Active omnidirectional antenna	R&S®HE314A1	4027.6505.02

Recommended extras

Bias unit	R&S®IN600	4094.3004.xx
Active vertical dipole	R&S®HE309E	4098.0000.02

Typical realized gain

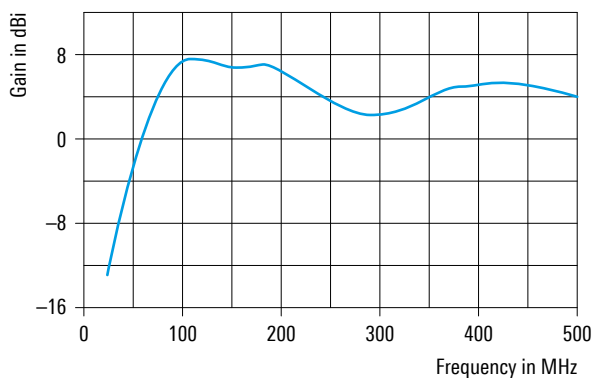

Typical antenna factor

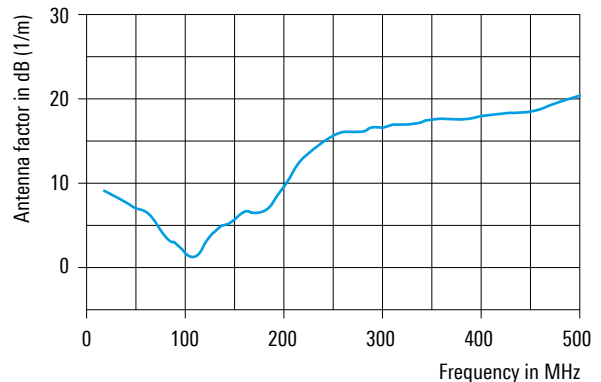

R&S®HE400 HANDHELD DIRECTIONAL ANTENNA

8.3 kHz to 8 GHz
For locating transmitters and interference sources

Update



The R&S®HE400 handheld directional antenna is used to locate transmitters and interference sources. Bearings are found by manually pointing the antenna in the direction where the signal is strongest.

The antenna is optimized to be used with the R&S®PR200 portable monitoring receiver, the R&S®PR100 portable receiver or the R&S®FSH and the R&S®Spectrum Rider FPH handheld spectrum analyzers as well as R&S®Cable Rider ZPH cable and antenna analyzer.

It consists of an antenna handle, receiver-customized cable sets and different antenna modules that can easily be attached using a locking ring. Seven different antenna modules are available, allowing the reception of vertically or horizontally polarized signals. The type of module and its orientation is detected by the antenna handle.

A built-in low-noise amplifier (LNA) can be activated in order to increase system sensitivity. In passive mode, the amplifier is bypassed and the antenna can also be used in the vicinity of strong transmitters.

The integrated electronic compass delivers exact azimuth and elevation data. Together with the sensitive GNSS receiver in the antenna handle, precise location accuracy is provided by triangulation.

The integrated trigger button can be used to externally trigger a receiver-configurable action.

Key facts

- ▶ Distinct directional pattern
- ▶ Wide dynamic range due to switchable active and passive mode (LNA on/off)
- ▶ Very wide frequency range in a compact size
- ▶ Automatic antenna module and polarization detection
- ▶ Trigger button for external triggering of the receiver
- ▶ Fatigue-free operation due to antenna design and materials used, which keep weight to a minimum
- ▶ GNSS receiver and electronic compass included
- ▶ Tripod thread and adapter thread for smartphone/tablet cradle
- ▶ Exchangeable cable set between antenna and receiver



R&S®HE400CEL



R&S®HE400SCB



R&S®HE400UWB



R&S®HE400LP



R&S®HE400HF



R&S®HE400SHF



R&S®HE400VHF

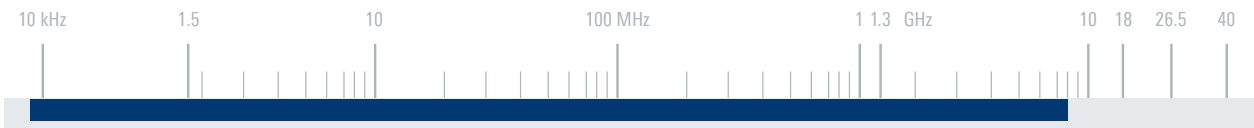

Specifications

RF specification of antenna handle

Frequency range	8.3 kHz to 8 GHz
Nominal impedance	50 Ω
VSWR (1 MHz to 8 GHz)	< 2.5; typ. 2

RF specification of antenna modules

Frequency range	<ul style="list-style-type: none"> ▶ R&S®HE400HF ▶ R&S®HE400VHF ▶ R&S®HE400UWB ▶ R&S®HE400LP ▶ R&S®HE400CEL ▶ R&S®HE400SCB ▶ R&S®HE400SHF 	<ul style="list-style-type: none"> ▶ 8.3 kHz to 30 MHz ▶ 20 MHz to 200 MHz ▶ 30 MHz to 6 GHz ▶ 450 MHz to 8 GHz ▶ 700 MHz to 2500 MHz ▶ 1.7 GHz to 6 GHz ▶ 5 GHz to 20 GHz¹⁾
	Polarization	adjustable, linear horizontal or vertical
Nominal impedance	50 Ω	
VSWR	< 3.5; typ. 2.0 except R&S®HE400HF module	
Dimensions	with R&S®HE400UWB antenna module	approx. 600 × 285 × 60 mm (24 × 11 × 2 in)
Weight	approx. 1.0 kg (2 lb)	

¹⁾ Can be used up to 8 GHz with R&S®HE400 antenna handle.

Ordering information

	Type	Order No.
Handheld directional antenna (antenna handle)	R&S®HE400	4104.6000.02
HF antenna module, 8.3 kHz to 30 MHz	R&S®HE400HF	4104.8002.02
VHF antenna module, 20 MHz to 200 MHz	R&S®HE400VHF	4104.8202.02
UWB antenna module, 30 MHz to 6 GHz	R&S®HE400UWB	4104.6900.02
Log-periodic antenna module, 450 MHz to 8 GHz	R&S®HE400LP	4104.8402.02
Cellular antenna module, 700 MHz to 2500 MHz	R&S®HE400CEL	4104.7306.02
S/C band antenna module, 1.7 GHz to 6 GHz	R&S®HE400SCB	4104.7606.02
SHF antenna module, 5 GHz to 20 GHz	R&S®HE400SHF	4104.8602.02
Cable set, for connecting R&S®HE400/R&S®HE400MW to R&S®PR100/FSH/FPH/ZPH	R&S®HE400-K	4104.7770.02
Serial to USB adapter, for connecting R&S®HE400/R&S®HE400MW to R&S®FPH	R&S®HE300USB	4080.9440.02
Cable set, for connecting R&S®HE400 to R&S®PR200	R&S®HE400-K	4104.7770.03

Recommended extras

Transport bags/cases are available for different configurations.

Tripod, for R&S®HE400 antenna family	R&S®HE400Z4	4104.9109.02
--------------------------------------	-------------	--------------

Measured realized gain of the R&S®HE400UWB

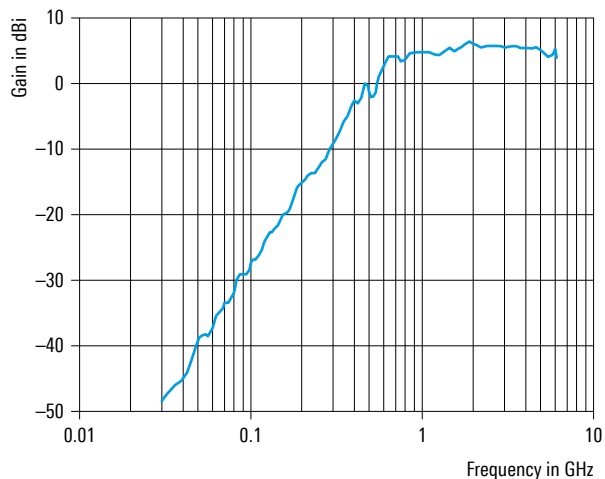

Meas. field patterns of the R&S®HE400UWB in the H plane

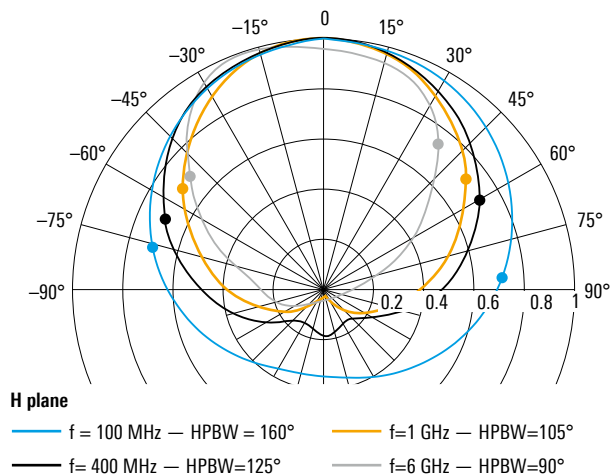

R&S®HE400DC HANDHELD DIRECTIONAL ANTENNA WITH DOWNCONVERTER

20 MHz to 20 GHz

For locating transmitters and interference sources

New



R&S®HE400VHF



R&S®HE400CEL



R&S®HE400LP



R&S®HE400UWB



R&S®HE400SCB



The R&S®HE400DC handheld directional antenna with downconverter extends the frequency range of the R&S®PR200 portable monitoring receiver from 8 GHz to 20 GHz. The antenna together with the R&S®PR200 is used to locate transmitters and interference sources. Bearings are found by manually pointing the antenna in the direction where the signal is strongest.

The antenna consists of an antenna handle, a receiver-customized cable set and different antenna modules that can easily be attached using a locking ring. Six different antenna modules are available, allowing the reception of vertically or horizontally polarized signals. The antenna handle detects the type of module and its orientation.

The integrated downconverter separates the frequency range from 8 GHz to 20 GHz into two bands (bands 1 and 2). Frequencies below 8 GHz (band 0) are bypassed.

A built-in low-noise amplifier (LNA) can be activated in order to increase system sensitivity. In passive mode, the amplifier is bypassed and the antenna can also be used in the vicinity of strong transmitters.

The integrated electronic compass delivers exact azimuth and elevation data. Together with the sensitive GNSS receiver in the antenna handle, precise location accuracy is provided by triangulation.

The integrated trigger button can be used to externally trigger a receiver-configurable action.

Key facts

- ▶ Distinct directional pattern
- ▶ Wide dynamic range due to switchable active and passive mode (LNA on/off)
- ▶ Very wide frequency range in a compact size
- ▶ Automatic antenna module and polarization detection
- ▶ Trigger button for external triggering of the receiver
- ▶ Fatigue-free operation due to antenna design and materials used, which keep weight to a minimum
- ▶ GNSS receiver and electronic compass included
- ▶ Tripod thread and adapter thread for smartphone/tablet cradle
- ▶ Exchangeable cable set between antenna and receiver

R&S®HE400SHF

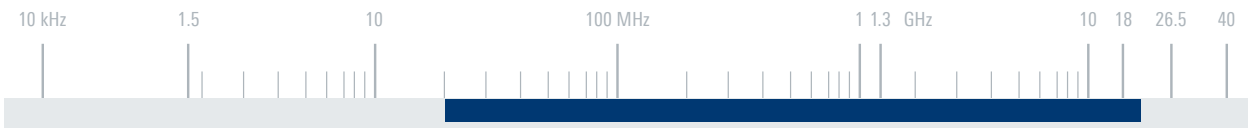

Specifications

RF specification of antenna handle

Frequency range		20 MHz to 20 GHz
Input frequency range	<ul style="list-style-type: none"> ▶ band 0 ▶ band 1 ▶ band 2 	<ul style="list-style-type: none"> ▶ 20 MHz to 8 GHz ▶ 8 GHz to 13.5 GHz ▶ 13.5 GHz to 20 GHz
Intermediate frequency range	<ul style="list-style-type: none"> ▶ band 0 (bypass) ▶ band 1 ▶ band 2 	<ul style="list-style-type: none"> ▶ 20 MHz to 8 GHz ▶ 6.4 GHz to 0.9 GHz ▶ 7.3 GHz to 0.8 GHz
Nominal impedance		50 Ω
VSWR		typ. 2.5

RF specification of antenna modules

Frequency range	<ul style="list-style-type: none"> ▶ R&S®HE400VHF ▶ R&S®HE400UWB ▶ R&S®HE400LP ▶ R&S®HE400CEL ▶ R&S®HE400SCB ▶ R&S®HE400SHF 	<ul style="list-style-type: none"> ▶ 20 MHz to 200 MHz ▶ 30 MHz to 6 GHz ▶ 450 MHz to 8 GHz ▶ 700 MHz to 2500 MHz ▶ 1.7 GHz to 6 GHz ▶ 5 GHz to 20 GHz
Polarization		adjustable, linear horizontal or vertical
Nominal impedance		50 Ω
VSWR		< 3.5; typ. 2.0
Dimensions	with R&S®HE400SHF antenna module	approx. 500 × 255 × 235 mm (20 × 10 × 9 in)
Weight		approx. 1.5 kg (3 lb)

Ordering information	Type	Order No.
Handheld directional antenna with downconverter (antenna handle)	R&S®HE400DC	4104.6000.05
VHF antenna module, 20 MHz to 200 MHz	R&S®HE400VHF	4104.8202.02
UWB antenna module, 30 MHz to 6 GHz	R&S®HE400UWB	4104.6900.02
Log-periodic antenna module, 450 MHz to 8 GHz	R&S®HE400LP	4104.8402.02
Cellular antenna module, 700 MHz to 2500 MHz	R&S®HE400CEL	4104.7306.02
S/C band antenna module, 1.7 GHz to 6 GHz	R&S®HE400SCB	4104.7606.02
SHF antenna module, 5 GHz to 20 GHz	R&S®HE400SHF	4104.8602.02
Cable set, for connecting R&S®HE400DC to R&S®PR200	R&S®HE400-K	4104.7770.05

Recommended extras

Transport bags/cases are available for different configurations.

Tripod, for R&S®HE400 antenna family	R&S®HE400Z4	4104.9109.02
--------------------------------------	-------------	--------------

Measured realized gain of R&S®HE400SHF

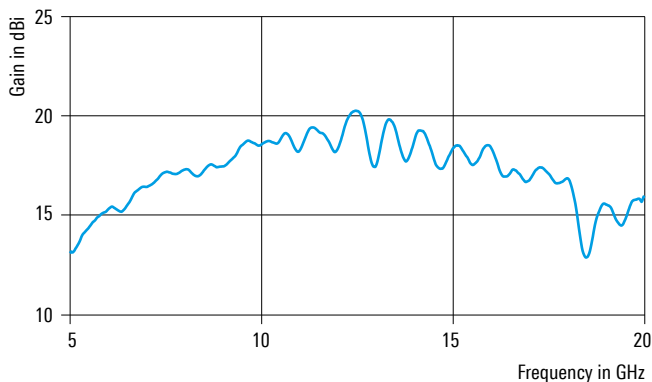

Measured field patterns of the R&S®HE400SHF in the H plane

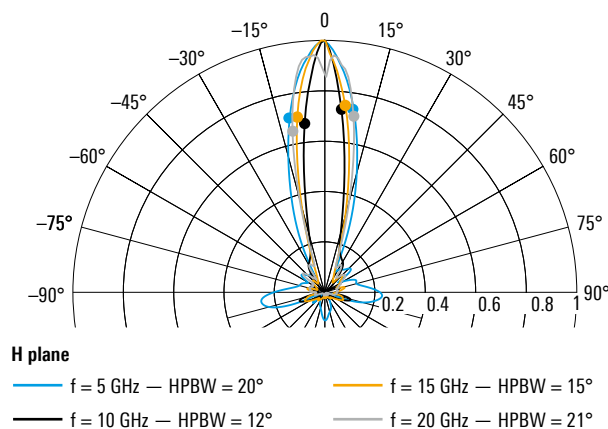

R&S®HE400MW MICROWAVE HANDHELD DIRECTIONAL ANTENNA

20 MHz to 20 GHz

For locating transmitters and interference sources



The R&S®HE400MW microwave handheld directional antenna is used to locate transmitters and interference sources. Bearings are found by manually pointing the antenna in the direction where the signal is strongest.

The antenna is optimized to be used with the R&S®FSH and the R&S®Spectrum Rider FPH handheld spectrum analyzers as well as R&S®Cable Rider ZPH cable and antenna analyzer.

It consists of an antenna handle, a receiver-customized cable set and different antenna modules that can easily be attached using a locking ring. Six different antenna modules are available, allowing the reception of vertically or horizontally polarized signals. The type of module and its orientation is detected by the antenna handle.

A built-in low-noise amplifier (LNA) can be activated in order to increase system sensitivity. In passive mode, the amplifier is bypassed and the antenna can also be used in the vicinity of strong transmitters.

The integrated electronic compass delivers exact azimuth and elevation data. Together with the sensitive GNSS receiver in the antenna handle, precise location accuracy is provided by triangulation.

The integrated trigger button can be used to externally trigger a receiver-configurable action.

Key facts

- ▶ Distinct directional pattern
- ▶ Wide dynamic range due to switchable active and passive mode (LNA on/off)
- ▶ Very wide frequency range in a compact size
- ▶ Automatic antenna module and polarization detection
- ▶ Trigger button for external triggering of the receiver
- ▶ Fatigue-free operation due to antenna design and materials used, which keep weight to a minimum
- ▶ GNSS receiver and electronic compass included
- ▶ Tripod thread and adapter thread for smartphone/tablet cradle
- ▶ Exchangeable cable set between antenna and receiver

New



R&S®HE400VHF



R&S®HE400CEL



R&S®HE400LP



R&S®HE400UWB



R&S®HE400SCB



R&S®HE400SHF

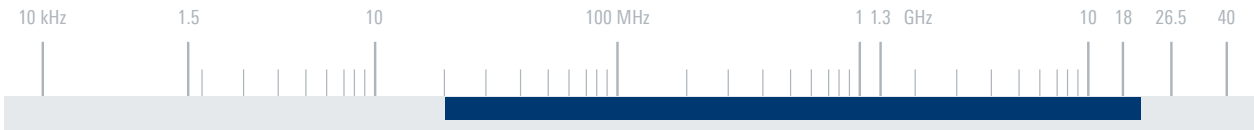

Specifications

RF specification of antenna handle

Frequency range	20 MHz to 20 GHz
Nominal impedance	50 Ω
VSWR	< 3.0; typ. 2.0

RF specification of antenna modules

Frequency range	<ul style="list-style-type: none"> ▶ R&S®HE400VHF ▶ R&S®HE400UWB ▶ R&S®HE400LP ▶ R&S®HE400CEL ▶ R&S®HE400SCB ▶ R&S®HE400SHF 	<ul style="list-style-type: none"> ▶ 20 MHz to 200 MHz ▶ 30 MHz to 6 GHz ▶ 450 MHz to 8 GHz ▶ 700 MHz to 2500 MHz ▶ 1.7 GHz to 6 GHz ▶ 5 GHz to 20 GHz
	Polarization	adjustable, linear horizontal or vertical
Nominal impedance	50 Ω	
VSWR	< 3.5; typ. 2.0	
Dimensions	with R&S®HE400UWB antenna module	approx. 600 × 285 × 60 mm (24 × 11 × 2 in)
Weight	approx. 1.0 kg (2 lb)	

Ordering information

	Type	Order No.
Microwave handheld directional antenna (antenna handle)	R&S®HE400MW	4104.6000.03
VHF antenna module, 20 MHz to 200 MHz	R&S®HE400VHF	4104.8202.02
UWB antenna module, 30 MHz to 6 GHz	R&S®HE400UWB	4104.6900.02
Log-periodic antenna module, 450 MHz to 8 GHz	R&S®HE400LP	4104.8402.02
Cellular antenna module, 700 MHz to 2500 MHz	R&S®HE400CEL	4104.7306.02
S/C band antenna module, 1.7 GHz to 6 GHz	R&S®HE400SCB	4104.7606.02
SHF antenna module, 5 GHz to 20 GHz	R&S®HE400SHF	4104.8602.02
Cable set, for connecting R&S®HE400/HE400MW to R&S®PR100/FSH/FPH/ZPH	R&S®HE400-K	4104.7770.02
Serial to USB adapter, for connecting R&S®HE400/HE400MW to R&S®FPH	R&S®HE300USB	4080.9440.02

Recommended extras

Transport bags/cases are available for different configurations.		
Tripod, for R&S®HE400 antenna family	R&S®HE400Z4	4104.9109.02

Measured realized gain of R&S®HE400SHF

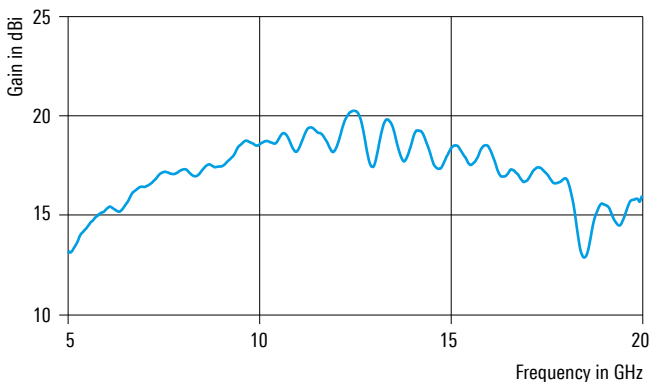

Measured field patterns of the R&S®HE400SHF in the H plane

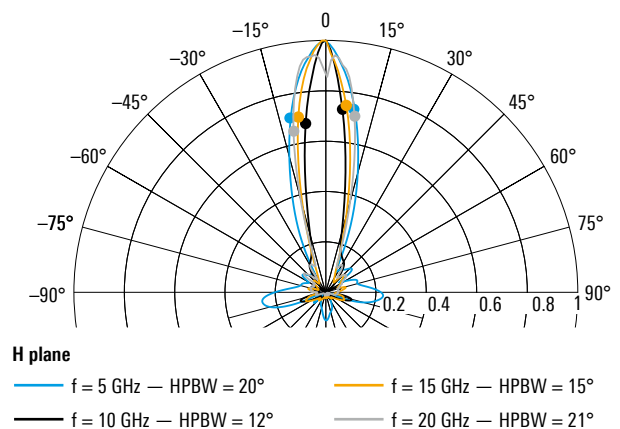

R&S®HE400BC BASIC HANDHELD DIRECTIONAL ANTENNA

8.3 kHz to 20 GHz

For locating transmitters and interference sources



The R&S®HE400BC basic handheld directional antenna is used to locate transmitters and interference sources. Bearings are found by manually pointing the antenna in the direction where the signal is strongest.

The antenna is optimized to be used with the R&S®PR200 portable monitoring receiver, the R&S®PR100 portable receiver or the R&S®FSH and the R&S®Spectrum Rider FPH handheld spectrum analyzers as well as R&S®Cable Rider ZPH cable and antenna analyzer.

It consists of an antenna handle, a receiver-customized cable set and different antenna modules that can easily be attached using a locking ring. Five different antenna modules are available, allowing the reception of vertically or horizontally polarized signals.

The R&S®HE400BC is fully passive, offers lowest insertion loss and uses a manual compass. The antenna handle has no LNA, so no power supply is required.

The antenna handle offers a cost effective solution for Rohde&Schwarz receivers and analyzers as well as third-party receivers.

Key facts

- ▶ Distinct directional pattern
- ▶ Very wide frequency range in a compact size
- ▶ Fatigue-free operation due to antenna design and materials used, which keep weight to a minimum
- ▶ Tripod thread and adapter thread for smartphone/tablet cradle
- ▶ Exchangeable cable set between antenna and receiver



R&S®HE400HF



R&S®HE400SHF



R&S®HE400UWB



R&S®HE400LP



R&S®HE400VHF

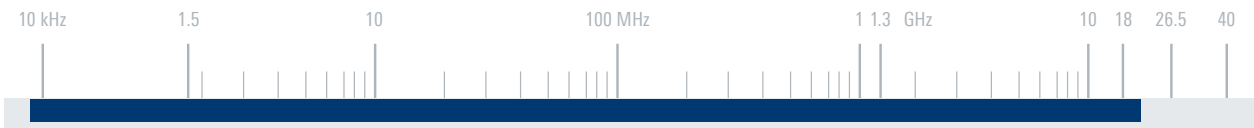

Specifications

RF specification of antenna handle

Frequency range	8.3 kHz to 20 GHz
Nominal impedance	50 Ω
VSWR	< 2.0; typ. 1.5

RF specification of antenna modules

Frequency range	<ul style="list-style-type: none"> ▶ R&S®HE400HF ▶ R&S®HE400VHF ▶ R&S®HE400UWB ▶ R&S®HE400LP ▶ R&S®HE400SHF 	<ul style="list-style-type: none"> ▶ 8.3 kHz to 30 MHz ▶ 20 MHz to 200 MHz ▶ 30 MHz to 6 GHz ▶ 450 MHz to 8 GHz ▶ 5 GHz to 20 GHz
Polarization	adjustable, linear horizontal or vertical	
Nominal impedance	50 Ω	
VSWR	< 3.5; typ. 2.0 except R&S®HE400HF module	
Dimensions	with R&S®HE400UWB antenna module	approx. 600 mm × 285 mm × 60 mm (24 in × 11 in × 2 in)
Weight	approx. 1.0 kg (2 lb)	

Ordering information

Ordering information	Type	Order No.
Basic handheld directional antenna (antenna handle)	R&S®HE400BC	4104.6000.04
HF antenna module, 8.3 kHz to 30 MHz	R&S®HE400HF	4104.8002.02
VHF antenna module, 20 MHz to 200 MHz	R&S®HE400VHF	4104.8202.02
UWB antenna module, 30 MHz to 6 GHz	R&S®HE400UWB	4104.6900.02
Log-periodic antenna module, 450 MHz to 8 GHz	R&S®HE400LP	4104.8402.02
SHF antenna module, 5 GHz to 20 GHz	R&S®HE400SHF	4104.8602.02
RF cable, for connecting R&S®HE400BC to R&S®PR200/R&S®PR100/FSH/FPH/ZPH or third-party receivers	R&S®HE400-KB	4104.7770.04

Recommended extras

Transport bags/cases are available for different configurations.

Tripod, for R&S®HE400 antenna family	R&S®HE400Z4	4104.9109.02
--------------------------------------	-------------	--------------

Measured realized gain of R&S®HE400SHF

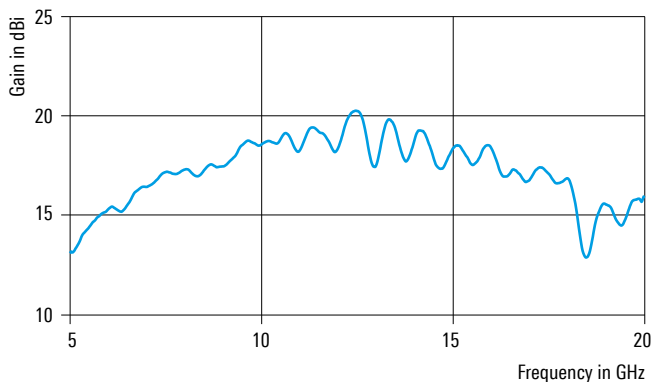

Measured field patterns of the R&S®HE400SHF in the H plane

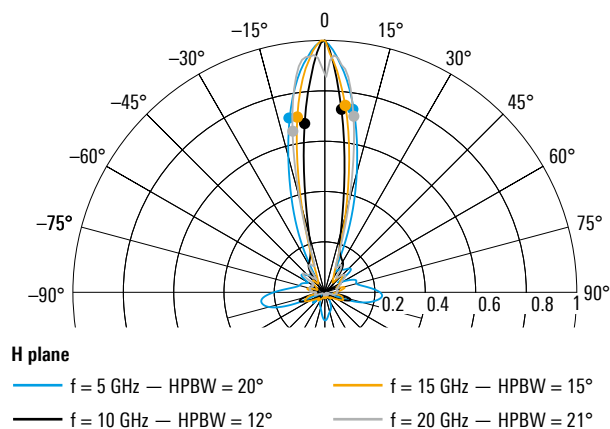

R&S®HE500 ACTIVE RECEIVING ANTENNA

20 MHz to 3 GHz

Good reception results in a compact size



The R&S®HE500 active receiving antenna has been designed as a monitoring antenna for vertical polarization and omnidirectional reception in the frequency range from 20 MHz to 3 GHz.

The antenna features a compact design and low weight, making it ideal for use in mobile systems and environments where space is at a premium.

A sturdy, composite radome protects the antenna and its electronics against the effects of weather and high wind speeds.

Key facts

- ▶ Extremely broadband
- ▶ Omnidirectional radiation pattern
- ▶ Low weight
- ▶ Compact size
- ▶ Weatherproof housing



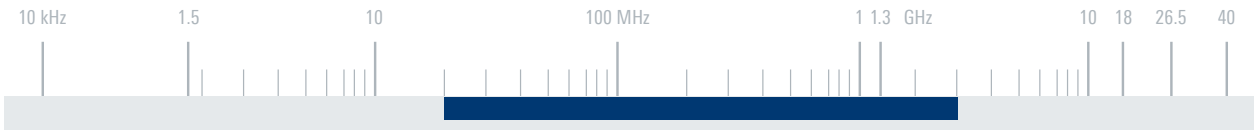

Specifications

Frequency range	20 MHz to 3 GHz	
Polarization	linear/vertical	
Input impedance	50 Ω	
VSWR	typ. < 3	
Horizontal radiation pattern	omnidirectional	
Antenna factor	see diagram	
Field strength sensitivity (S/N = 0 dB, Δf = 1 Hz)	20 MHz to 1.3 GHz	typ. -23 dB(μV/m)
	1.3 GHz to 3 GHz	typ. -20 dB(μV/m)
Destructive field strength	typ. > 50 V/m	
IP2	20 MHz to 900 MHz	typ. > 50 dBm
	> 900 MHz to 3 GHz	typ. > 30 dBm
IP3	typ. > 25 dBm	
Power supply	18 V to 32 V DC (max. 180 mA)	
Connector	N female	
MTBF	> 50000 h	
Operating temperature range	-40°C to +65°C	
Max. wind speed	model .02	250 km/h
	model .14	600 km/h (only on narrow side)
Dimensions	W × H × L	approx. 65 mm × 365 mm × 170 mm (3 in × 14 in × 7 in)
Weight	approx. 1.2 kg (3 lb)	

Ordering information

Ordering information	Type	Order No.
Active receiving antenna	R&S®HE500	4059.2005.02
Active receiving antenna, for use on aircraft	R&S®HE500	4059.2005.14

Recommended extra

Bias unit	R&S®IN600	4094.3004.xx
-----------	-----------	--------------

Typical antenna factor

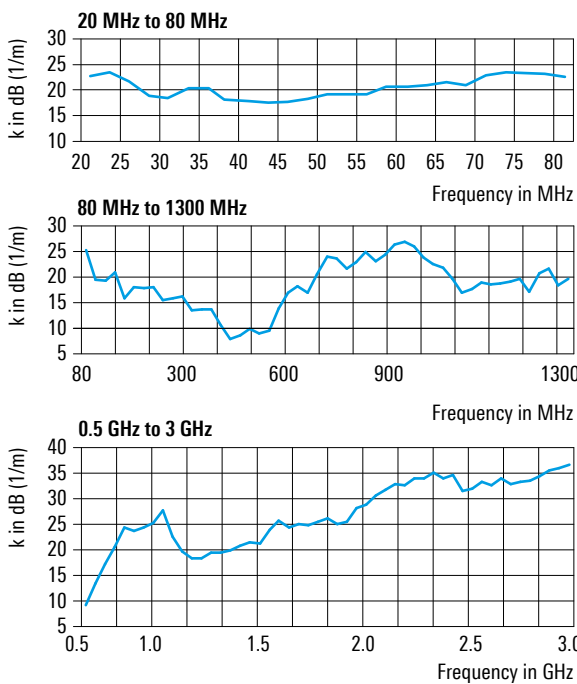

Typical VSWR characteristic

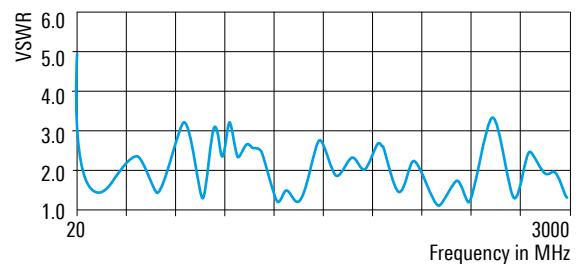

R&S®HE600 ACTIVE OMNIDIRECTIONAL RECEIVING ANTENNA

20 MHz to 8 GHz

Sensitive monitoring in stationary and mobile installations



The R&S®HE600 active omnidirectional receiving antenna is designed as a monitoring antenna for vertical polarization in the frequency range from 20 MHz to 8 GHz.

The integrated preamplifier provides good reception results in a compact size.

The dipole concept delivers superior radiation characteristics even without the presence of a ground plane.

A low-attenuation, weather-resistant radome makes the antenna suitable for operation under harsh environmental conditions.

Key facts

- ▶ Extremely wide frequency range
- ▶ Vertical polarization
- ▶ High sensitivity
- ▶ Low weight
- ▶ Compact size
- ▶ Suitable for operation under harsh environmental conditions



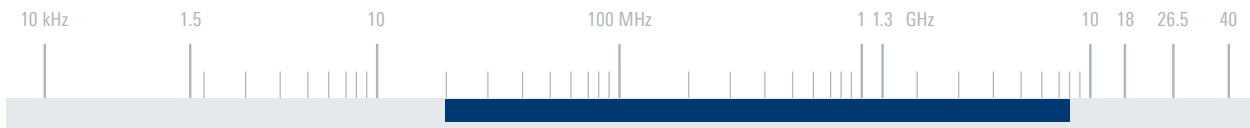

Specifications

Frequency range		20 MHz to 8 GHz
Polarization		linear/vertical
RF connector		N female, 50 Ω
VSWR		typ. < 2
Gain and antenna factor		see diagram
Field strength sensitivity		see diagram
Circularity of azimuth pattern		typ. < 3 dB
IP3	20 MHz to 1.1 GHz	typ. > 28 dBm
	> 1.1 GHz to 3 GHz	typ. > 22 dBm
	> 3 GHz	typ. > 20 dBm
IP2	20 MHz to 1.1 GHz	typ. > 50 dBm
	> 1.1 GHz to 3 GHz	typ. > 38 dBm
	> 3 GHz	typ. > 32 dBm
Destructive field strength		> 50 V/m
Power supply (via coaxial cable)		15 V to 28 V DC (typ. 24 V, max. 180 mA)
Operating temperature range		-40°C to +65°C
Storage temperature range		-40°C to +85°C
Protection class		IP55
Max. wind speed	without ice deposit	275 km/h
	with 30 mm ice deposit	200 km/h
MTBF		> 100000 h
Dimensions	Ø × H	approx. 135 mm × 550 mm (5 in × 22 in)
Weight		approx. 2 kg (4 lb)

Ordering information

Type

Order No.

Active omnidirectional receiving antenna	R&S®HE600	
Color: squirrel gray (RAL 7000)		4094.9002.02
Color: bronze green (RAL 6031)		4094.9002.03
Color: light ivory (RAL 1015)		4094.9002.04
Recommended extras		
Bias unit	R&S®IN600	4094.3004.xx
Mast and tripod adapter	R&S®KM011Z9	4095.0750.02
Wooden tripod	R&S®HZ-1	0837.2310.02

Typical gain and antenna factor

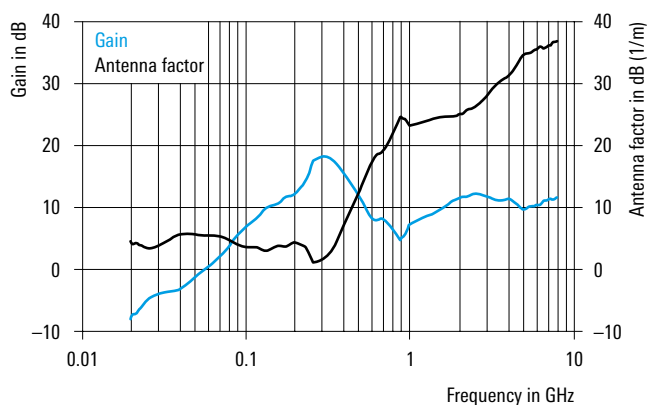

Typical field strength sensitivity at antenna output (Δf = 1 Hz, S/N = 0 dB)

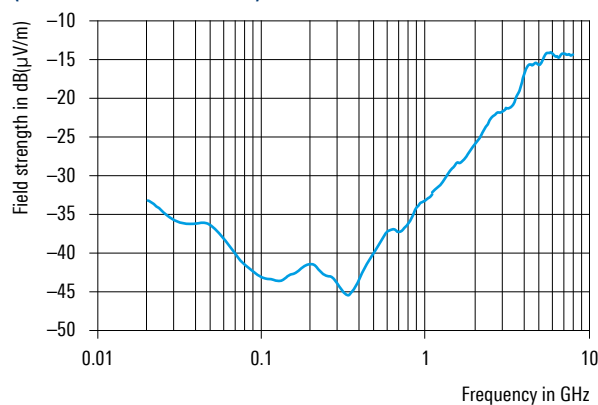

R&S®HK116E BICONICAL ANTENNA

20 MHz to 300 MHz

For radiated emission measurements



The R&S®HK116E is a biconical dipole antenna for linearly polarized waves.

The antenna features a wide frequency range, a radiation pattern virtually independent of frequency and low weight.

The mounting system of the biconical radiators ensures fixed orientation of the crossbars leading to high reproducibility of electrical performance (in line with recommendation in CISPR 16-1-6).

Key facts

- ▶ Wide frequency range
- ▶ Low frequency dependence of the radiation pattern
- ▶ Compliant with requirements for balun imbalance and cross-polar performance given in CISPR 16-1-4 Ed. 4.0
- ▶ Dimensions in line with MIL-STD-461G
- ▶ Easy and quick way to mount/demount the biconical radiators
- ▶ Low uncertainty antenna as defined by CISPR 16-1-4
- ▶ Very low cross-polarization for accurate determination of the electrical field vector
- ▶ Individual calibrations in line with ANSI C63.5, CISPR 16-1-6 and SAE ARP958
- ▶ Accredited calibration available on request

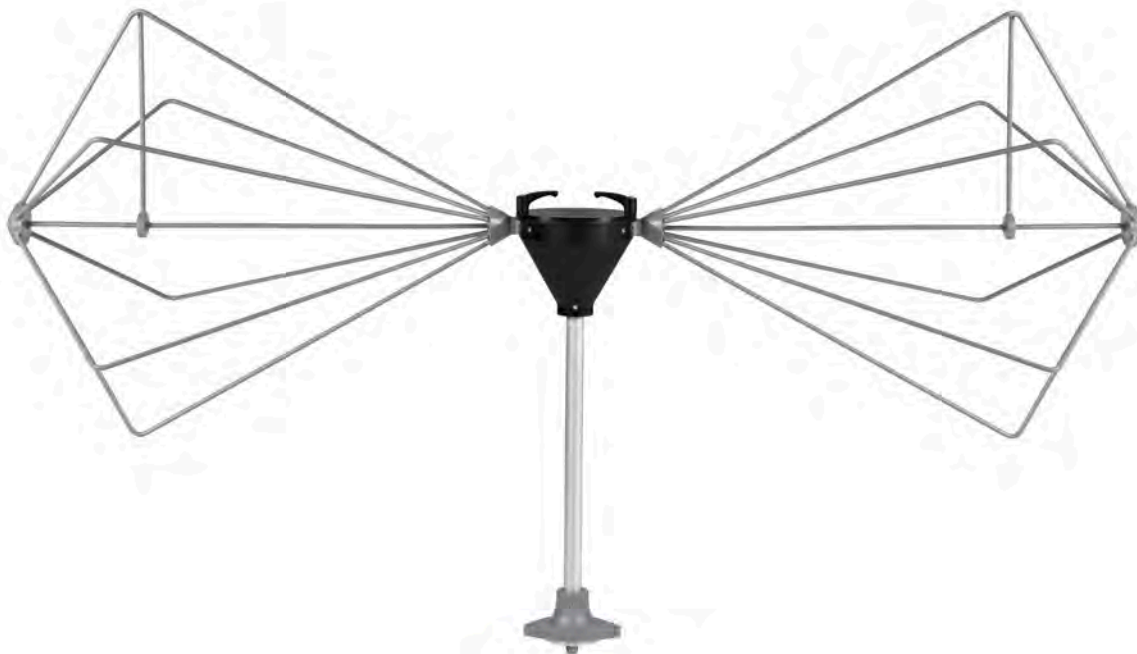

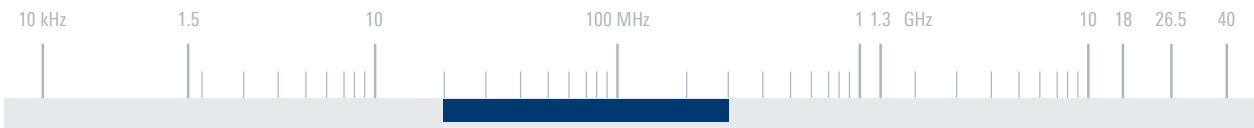

Specifications

Frequency range	20 MHz to 300 MHz	
Polarization	linear	
Nominal impedance	50 Ω	
VSWR	see diagram	
Permissible input power	75 W CW	
Cross-polarization	< -20 dB; typ. -25 dB	
RF connector	N female	
MTBF	>100000 h	
Operating temperature range	-40°C to +55°C	
Storage temperature range	-40°C to +70°C	
Dimensions	W × H × L	approx. 0.53 m × 0.78 m × 1.37 m (21 in × 31 in × 54 in)
Weight	approx. 3 kg (7 lb)	

Ordering information

Ordering information	Type	Order No.
Biconical antenna	R&S®HK116E	4099.9000.02

Recommended extras

Wooden tripod	R&S®HZ-1	0837.2310.02
Adapter for use on R&S®HZ-1	R&S®KM011Z10	4100.1703.02

Typical VSWR

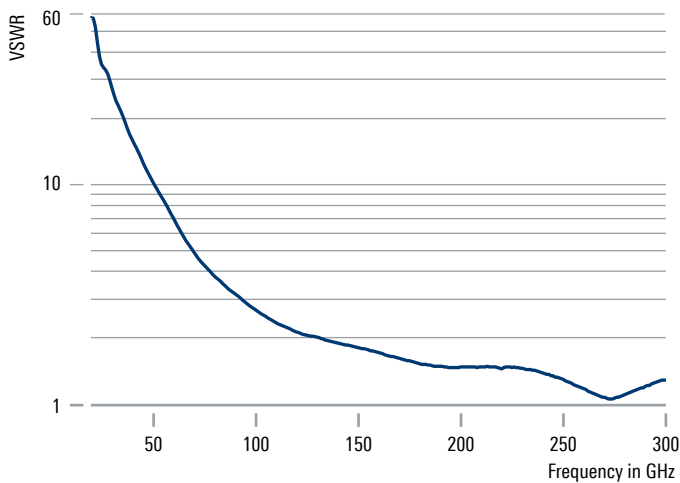

Typical E plane pattern

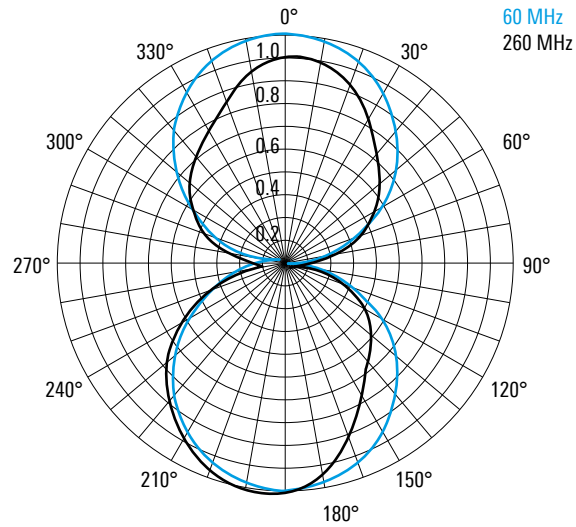

R&S®HL007A2 CROSSED LOG- PERIODIC ANTENNA

80 MHz to 1.3 GHz

Monitoring and measurement of RF signals



The R&S®HL007A2 log-periodic antenna with crossed elements is particularly suitable for monitoring and measuring RF signals.

The antenna features a virtually frequency-independent radiation pattern and allows horizontally and vertically polarized signals to be received.

Polarization switching (optional) can also be remote controlled.

Key facts

- ▶ Wide frequency range
- ▶ Virtually frequency-independent radiation pattern
- ▶ Polarization horizontal and vertical (selectable with R&S®ZS107 option)
- ▶ Remote controlled polarization switching with R&S®GB016 and R&S®ZS107 or R&S®OSP220/OSP230 with R&S®OSP-BS016 and R&S®ZS107



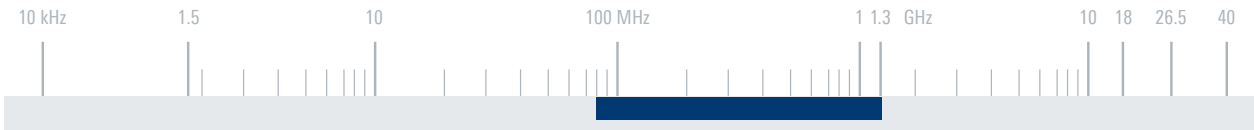

Specifications		
Frequency range		80 MHz to 1.3 GHz
Polarization		linear horizontal, vertical (optional ±45°)
Input impedance		50 Ω
VSWR		≤ 2.5
Gain		typ. 6 dBi
Antenna connector		2 × N female
Operating temperature range		-40°C to +50°C
Max. wind speed	without ice deposit	180 km/h
MTBF		> 100 000 h
Dimensions	W × H × L	approx. 2 m × 2.2 m × 1.7 m (7 ft × 7 ft × 6 ft)
Weight		approx. 18 kg (40 lb)

Ordering information	Type	Order No.
Crossed log-periodic antenna	R&S®HL007A2	4025.8700.03
Recommended extras		
Polarization network switch for horizontal/vertical polarization	R&S®ZS107	0428.2853.04
Control unit	R&S®GB016	4056.7006.03
Antenna remote control software (ARCOS)	R&S®CP001	4069.6384.05
Module for R&S®OSP, for controlling R&S®HL024Sx and R&S®HL050S7	R&S®OSP-BS016	4118.6007.03
Open switch and control platform, without touchscreen	R&S®OSP-220	1528.3105.02
Open switch and control platform, with touchscreen	R&S®OSP-230	1528.3105.03

Typical gain and polarization decoupling

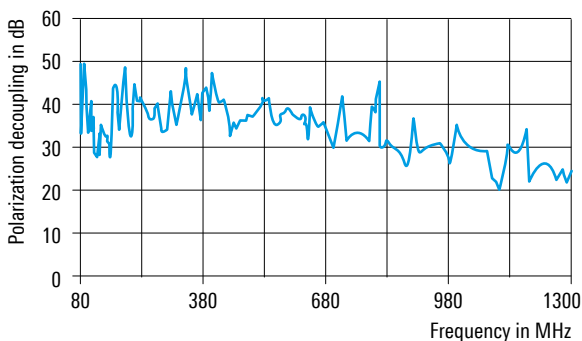
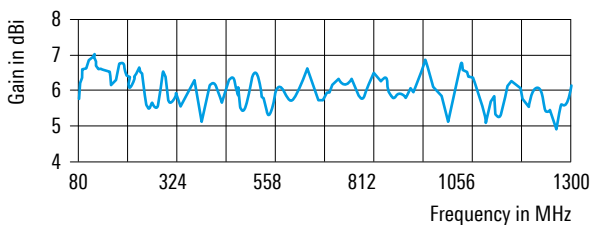

Typical radiation patterns

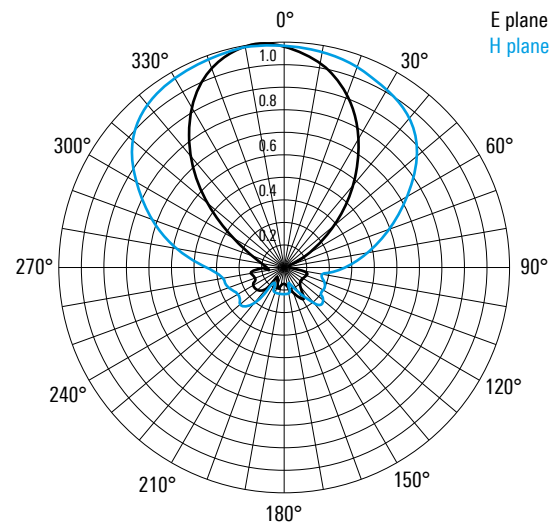

R&S®HL033 LOG-PERIODIC BROADBAND ANTENNA

80 MHz to 2 GHz

Detection and measurement of RF signals



In conjunction with a test or monitoring receiver, the R&S®HL033 log-periodic broadband antenna can be used for versatile applications, e.g. field strength measurements or determination of direction of incidence and signal polarization.

The R&S®HL033 can also be used as a transmit antenna over the entire frequency range.

Key facts

- ▶ Extremely broadband
- ▶ Only one antenna required to cover a wide frequency range
- ▶ Low frequency-dependence of radiation patterns and input impedance
- ▶ Usable as transmit antenna
- ▶ Metal parts electrically connected to mast flange for protection against electric charges and lightning
- ▶ Highly weatherproof
- ▶ Stable installation due to optional adapter for center support
- ▶ Individual calibrations in line with ANSI C63.5 and CISPR 16-1-6
- ▶ Accredited calibration available on request



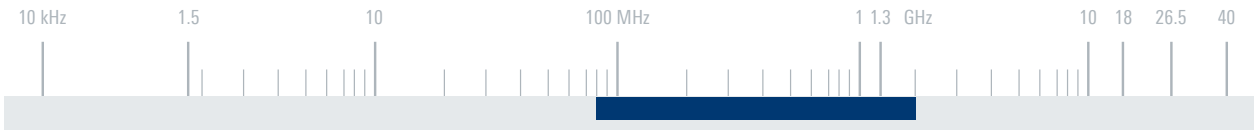

Specifications

Frequency range		80 MHz to 2 GHz
Polarization		linear
Input impedance		50 Ω
VSWR		typ. ≤ 2
Max. input power (T _A = +30°C)	80 MHz	460 W + 100% AM
	100 MHz	430 W + 100% AM
	500 MHz	210 W + 100% AM
	1000 MHz	160 W + 100% AM
	1500 MHz	140 W + 100% AM
	2000 MHz	120 W + 100% AM
Gain		typ. 6.5 dBi (see diagram)
Connector		N female
MTBF		> 100 000 h
Operating temperature range		-40°C to +50°C
Max. wind speed	without ice deposit	150 km/h
Dimensions	W × L	approx. 1.96 m × 1.8 m (6 ft × 6 ft)
Weight		approx. 6 kg (13 lb)

Ordering information

Ordering information	Type	Order No.
Log-periodic broadband antenna	R&S®HL033	4062.6608.03

Recommended extra

Adapter for center support	R&S®HL033M	4062.7585.03
----------------------------	------------	--------------

Typical gain

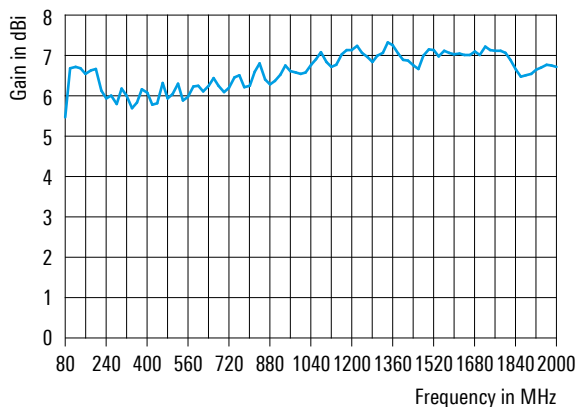

Typical radiation patterns

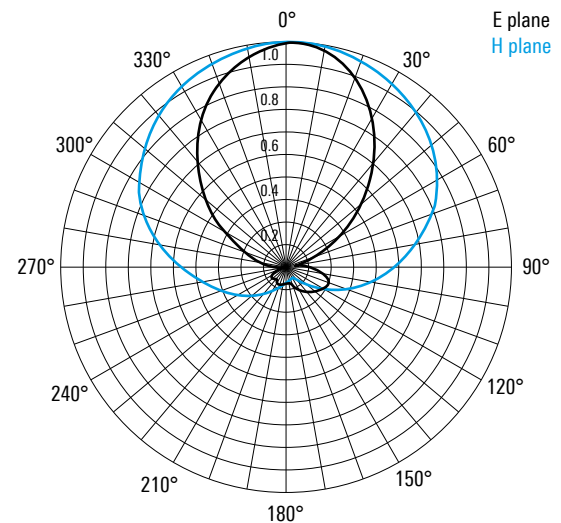

R&S®HL040E LOG-PERIODIC BROADBAND ANTENNA

400 MHz to 6 GHz

For broadband transmission and reception under open-field and laboratory conditions



The linearly polarized R&S®HL040E log-periodic broadband antenna provides broadband transmission and reception in the frequency range from 400 MHz to 6 GHz.

Precise construction and optionally available individual calibration make the antenna suitable for field strength and EMI measurements.

Power rating and matching (VSWR) allow its use in EMS measurements where field strengths of 10 V/m or higher are required.

Key facts

- ▶ Wide frequency range
- ▶ Suitable for susceptibility and emission measurements
- ▶ Stable radiation patterns over frequency range ensure optimum illumination of EUT
- ▶ Low cross-polarization
- ▶ Compact size, low weight
- ▶ Ease of handling
- ▶ Sturdy design
- ▶ Individual calibrations in line with ANSI C63.5 and CISPR 16-1-6
- ▶ Accredited calibration available on request



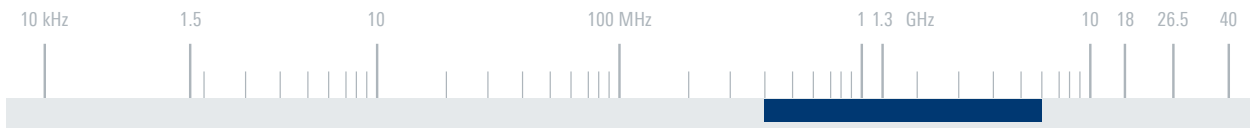

Specifications

Frequency range		400 MHz to 6 GHz
Polarization		linear
Nominal impedance		50 Ω
VSWR		< 2.0
Gain		typ. 5.5 dBi
Cross-polarization		typ. -25 dB
Front-to-back-ratio	400 MHz to 4.5 GHz	> 20 dB
	4.5 GHz to 6 GHz	> 15 dB
Maximum input power (at +40°C)	400 MHz	100 W CW
	1 GHz	90 W CW
	3 GHz	50 W CW
	6 GHz	35 W CW
RF connector		N female
MTBF		> 100 000 h
Operating temperature range		-40°C to +70°C
Protection class		IP55
Max. wind speed	without ice deposit	275 km/h
Dimensions	W × H × L	approx. 0.43 m × 0.13 m × 0.55 m (17 in × 5 in × 22 in)
Weight		approx. 2.5 kg (6 lb)

Ordering information

	Type	Order No.
Log-periodic broadband antenna, without calibration	R&S®HL040E	4099.8004.02
Log-periodic broadband antenna, with factory standard calibration	R&S®HL040E	4099.8004.12

Recommended extras

Wooden tripod	R&S®HZ-1	0837.2310.02
Adapter for R&S®HZ-1	R&S®HL025Z1	4053.4006.03

Typical VSWR

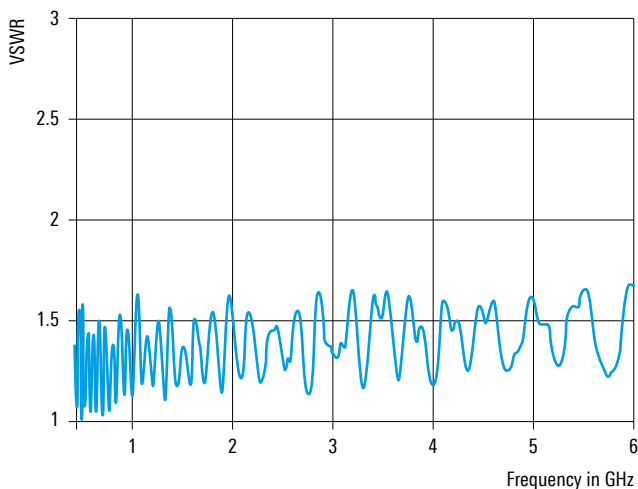

Typical antenna factor

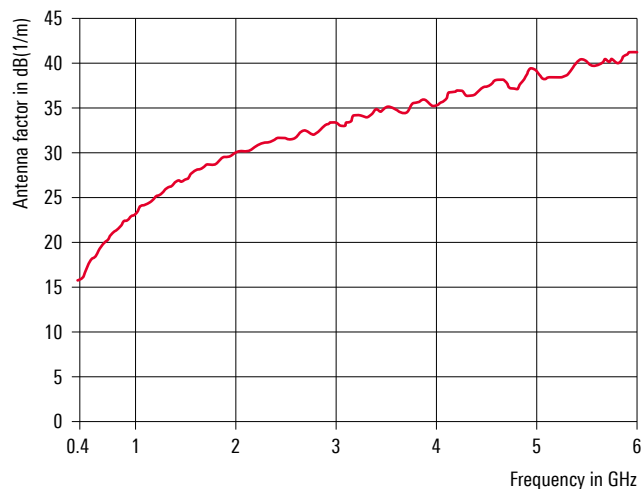

R&S®HL047 HIGH GAIN LOG- PERIODIC ANTENNA

80 MHz to 6 GHz

Log-periodic antenna for EMS measurements

New



The R&S®HL047 high gain log-periodic antenna offers excellent broadband characteristics and a radiation pattern that is approximately rotation-symmetrical, making it particularly suitable for EMS immunity testing.

The high antenna gain means that in comparison with existing systems, the required field strengths can be achieved with a lower amplifier power.

The end radiators are detachable to reduce the antenna dimensions and weight for easy transportation and storage. Operation at frequencies above 200 MHz is possible without the end radiators.

Its compact size, extremely wide frequency range and detachable radiators make the antenna ideal for use in test chambers.

Key facts

- ▶ High antenna gain, i.e. low amplifier power required
- ▶ Suitable for susceptibility and emission measurements
- ▶ No change of antennas needed over wide frequency range
- ▶ Uniform object irradiation due to optimized radiation patterns
- ▶ Compact size
- ▶ Antenna gain approximately constant over the whole frequency range
- ▶ Detachable radiator structure allows measurements with smaller antenna for frequencies above 200 MHz



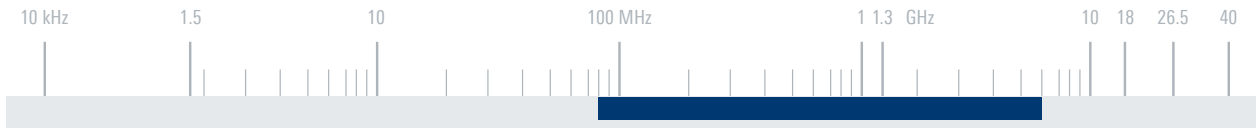

Specifications

Frequency range	80 MHz to 6 GHz, without rear radiators 200 MHz to 6 GHz	
Polarization	linear	
Input impedance	50 Ω	
VSWR	typ. < 2	
Realized gain	typ. 9 dBi	
Max. input power (T = +40°C)	80 MHz	1400 W CW
	1 GHz	500 W CW
	3 GHz	300 W CW
	6 GHz	200 W CW
Connector	N female	
Operating temperature range	+5°C to +40°C, in line with MIL-STD-810E	
Class of application	laboratory, anechoic chamber	
Dimensions (W × H × L)	without tripod	approx. 1.07 m × 1.89 m × 1.96 m (42 in × 74 in × 77 in)
	without rear radiators	approx. 0.71 m × 0.97 m × 1.3 m (28 in × 38 in × 51 in)
	with tripod	approx. 1.07 m × 2.15 m × 1.96 m (42 in × 85 in × 77 in)
	without rear radiators	approx. 0.71 m × 1.69 m × 1.3 m (28 in × 67 in × 51 in)
Weight	without tripod	approx. 10 kg (20 lb)
	with tripod	approx. 22 kg (45 lb)

Ordering information

	Type	Order No.
High gain log-periodic antenna	R&S®HL047	4108.8007.02
Recommended extra		
Movable tripod	R&S®HL047Z1	4108.8820.02

Typical VSWR

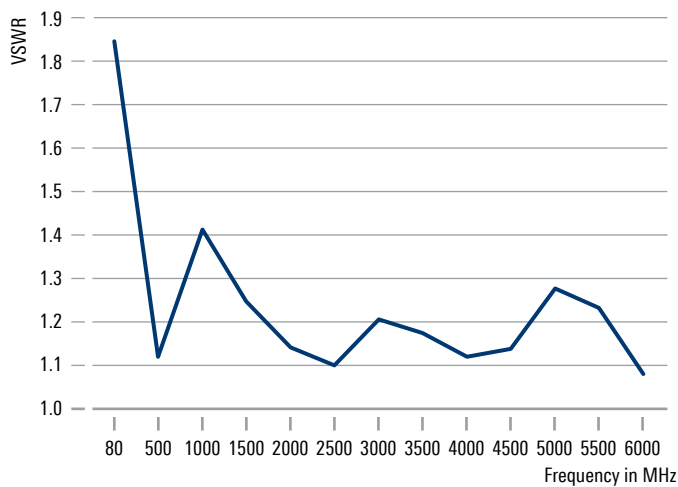

R&S®HL223 LOG-PERIODIC ANTENNA

200 MHz to 1.3 GHz

Optimized for radiomonitoring and measurements



With its broadband characteristics and virtually frequency-independent radiation patterns, the R&S®HL223 log-periodic antenna covers a very wide frequency range.

The sturdy construction makes the antenna suitable for stationary and mobile applications.

Each antenna is supplied with an individual calibration certificate so that it can be used for measurements and for monitoring and transmitting applications.

Key facts

- ▶ Excellent broadband characteristics
- ▶ Virtually frequency-independent radiation pattern
- ▶ Only one antenna required to cover a wide frequency range
- ▶ Sturdy construction
- ▶ Suitable for mobile use
- ▶ Adapter for R&S®HZ-1 wooden tripod supplied with antenna
- ▶ Individual calibrations in line with ANSIC63.5, CISPR 16-1-6 and SAEARP958
- ▶ Accredited calibration available on request



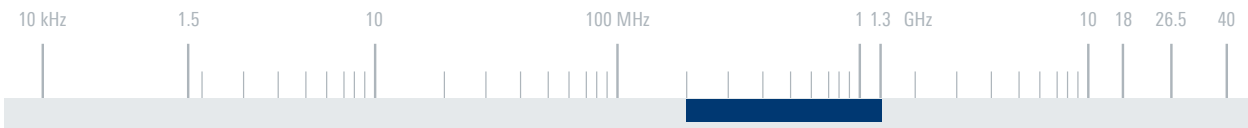

Specifications

Frequency range	200 MHz to 1.3 GHz	
Polarization	linear	
Input impedance	50 Ω	
VSWR	typ. < 2	
Max. input power (at +20°C)	1500 W to 600 W CW	
Gain	typ. ≥ 6 dBi	
Connector	N female	
MTBF	100000 h	
Operating temperature range	-40°C to +50°C	
Max. wind speed	without ice deposit	200 km/h
Dimensions	W × H × L	approx. 765 mm × 120 mm × 710 mm (30 in × 5 in × 28 in)
Weight	approx. 2 kg (4 lb)	

Ordering information

Ordering information	Type	Order No.
Log-periodic antenna	R&S®HL223	4001.5501.02

Recommended extra

Wooden tripod	R&S®HZ-1	0837.2310.02
---------------	----------	--------------

Typical gain

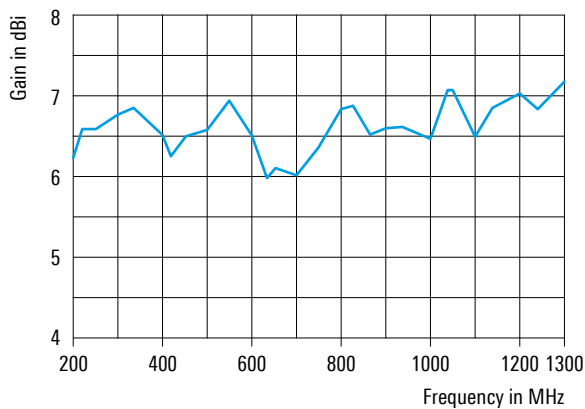

Typical directional radiation patterns at 750 MHz

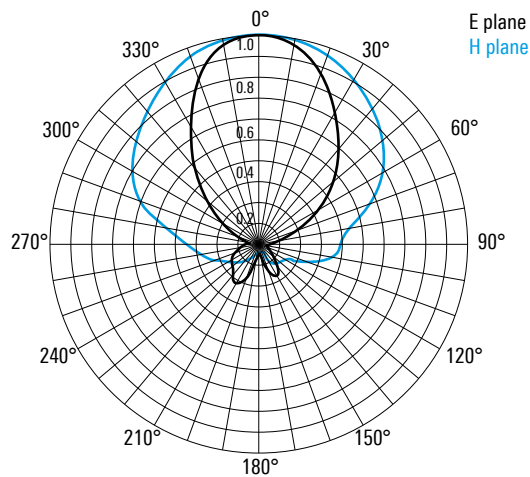

R&S®HL562E ULTRALOG

30 MHz to 6 GHz

Ultrabroadband antenna for EMI and
EMS applications



The R&S®HL562E ULTRALOG is used for emission measurements and immunity tests in the wide frequency range from 30 MHz to 6000 MHz. Measurement times are considerably reduced since it is not necessary to change antennas. Symmetry of radiation patterns and matching (VSWR) of the R&S®HL562E allow its use in EMS measurements where field strengths of 10 V/m or higher are required.

The R&S®HL562E combines the characteristics of a biconical and a log-periodic antenna. The log-periodic part of the antenna is V-shaped in order to increase gain and to achieve an almost rotation-symmetrical radiation pattern (above 200 MHz).

The ULTRALOG is supplied without a tripod; the tripod shown is available as an extra.

Key facts

- ▶ Suitable for immunity tests and emission measurements
- ▶ No change of antennas needed throughout the whole frequency range
- ▶ Radiation patterns in E and H plane practically rotationally symmetrical (from 200 MHz to 6000 MHz)
- ▶ Compact size, low weight
- ▶ High gain, low antenna factor
- ▶ Movable tripod optionally available
- ▶ Factory standard calibration included
- ▶ Individual calibrations in line with ANSIC63.5, CISPR 16-1-6 and SAE ARP958
- ▶ Accredited calibration available on request



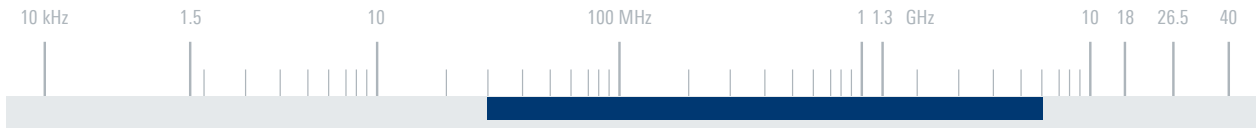

Specifications

Frequency range	30 MHz to 6 GHz	
Polarization	linear	
Cross-polarization	typ. < -25 dB	
VSWR	above 200 MHz	typ. < 2
RF connector	N female	
Nominal impedance	50 Ω	
Gain	above 200 MHz	typ. 8.5 dBi
MTBF	> 100 000 h	
Max input power	30 MHz	225 W CW
	80 MHz	900 W CW
	250 MHz	750 W CW
	1 GHz	420 W CW
	3 GHz	270 W CW
	6 GHz	150 W CW
Operating temperature range	-40°C to +40°C	
Class of operation	laboratory, anechoic chamber, outdoor use up to 20 km/h wind speed	
Dimensions (W × H × L)	approx. 0.57 m × 1.43 m × 1.65 m (22 in × 56 in × 65 in)	
Weight	approx. 5 kg (11 lb)	

Ordering information

Ordering information	Type	Order No.
ULTRALOG	R&S®HL562E	4100.0007.03
Recommended extras		
Movable tripod	R&S®HL562Z1	4041.3900.02
Attenuator, 4 dB, 2 W (hybrid antenna impedance matching pad (HAIMP))	R&S®HL562E-ATT	4100.0536.00

Typical antenna factor

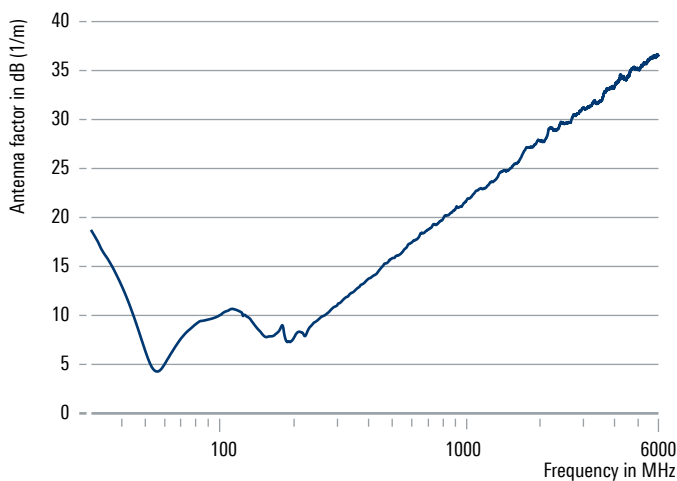

Typical radiation patterns

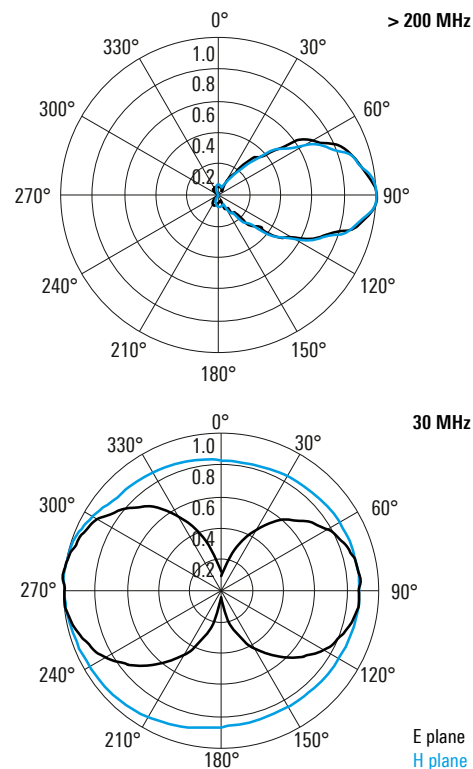

R&S®AD033V3 OMNIDIRECTIONAL UHF ANTENNA

225 MHz to 450 MHz

Compact UHF transmitting/receiving antenna for
naval applications



The R&S®AD033V3 is an omnidirectional UHF antenna for naval applications. The antenna can be used for transmitting or for receiving only.

Eight vertically polarized dipoles are circularly arranged around a center support structure and combined to one output, resulting in an excellent omnidirectional behavior.

The R&S®AD033V3 can fit around mast diameters of up to 670 mm. The antenna is delivered in two prefitted half-shells for easy mounting to existing masts. Even refitting to existing ship structures is possible.

Key facts

- ▶ Excellent omnidirectionality
- ▶ High input power for simultaneous use of multiple radio lines
- ▶ Stackable antenna design
- ▶ Reduced RCS
- ▶ Protected against lightning strikes by DC grounding
- ▶ For naval applications



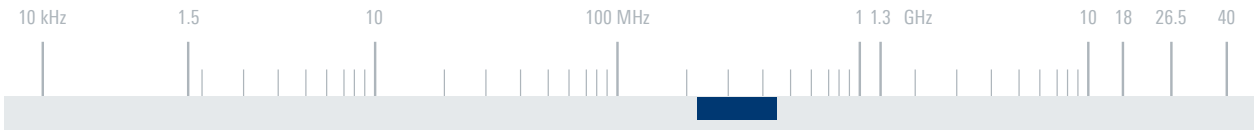

Specifications

Frequency range		225 MHz to 450 MHz
Connector		7/16 (female), 50 Ω
VSWR		typ. 2.0
Gain		typ. 2 dBi
Polarization		linear, vertical
Polarization decoupling		≥ 20 dB
Input power		max. 600 W CW
Azimuth pattern		omnidirectional
Max. deviation from circularity	225 MHz to 400 MHz	typ. < ±0.75 dB
	> 400 MHz to 450 MHz	typ. < ±1 dB
Operating temperature range		-30°C to +55°C
Protection class		IP56
Max. wind speed	without ice deposit	275 km/h
	with 30 mm ice deposit	180 km/h
Dimensions	diameter × height	approx. 1270 mm × 1000 mm (50 in × 39 in)
	inner diameter	approx. 670 mm (26 in)
Weight		approx. 85 kg (187 lb)

Ordering information	Type	Order No.
Omnidirectional UHF antenna, color: squirrel gray (RAL 7000)	R&S®AD033V3	4091.0004.02

Typical antenna gain

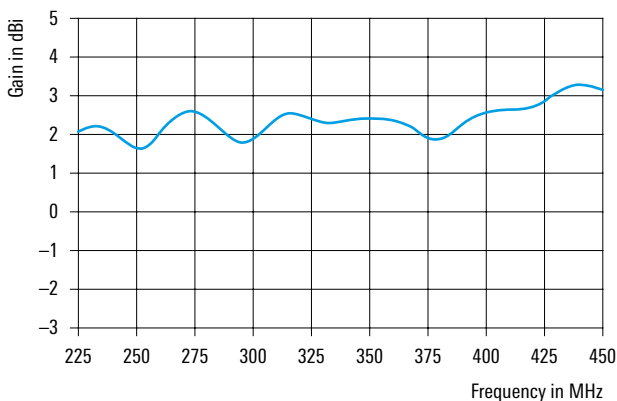

Typical radiation patterns at 300 MHz

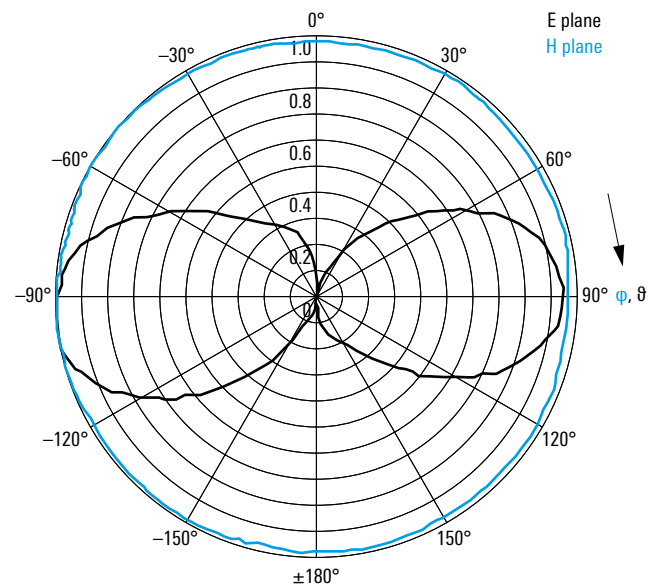

R&S® AD066FW BROADBAND VHF/UHF COMMUNICATIONS ANTENNA SYSTEM

118 MHz to 453 MHz

Compact VHF/UHF transmitting/receiving antenna system for naval applications



The R&S®AD066FW is an omnidirectional VHF/UHF antenna system for naval applications. The system can be used for transmitting or for receiving only.

The R&S®AD066FW consists of the R&S®AD066F broadband VHF/UHF communications antenna, the R&S®FT066F beamforming network and the applicable R&S®AD066FW-K cable sets.

Eight vertically polarized dipoles are circularly arranged around a center support structure and combined by the beamforming network (BFN) to one output, resulting in an excellent omnidirectional behavior. The beamforming network can also be custom-designed to meet special customer requirements.

The R&S®AD066FW can fit around mast diameters of up to 700 mm. The antenna is delivered in eight identical segments for easy mounting and servicing.

Key facts

- ▶ Wide frequency range
- ▶ Excellent omnidirectionality
- ▶ High input power for simultaneous use of multiple radio lines
- ▶ Stackable antenna design
- ▶ Vertical polarization
- ▶ Especially designed for operation under harsh environmental conditions



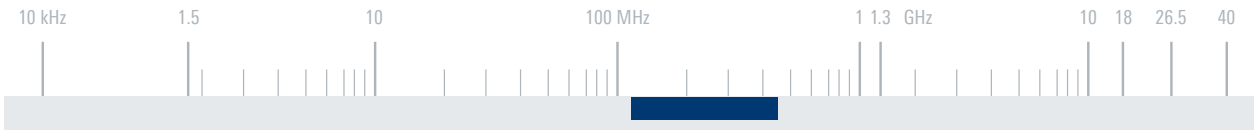

Specifications

R&S®AD066F

Frequency range	118 MHz to 453 MHz
Input impedance	50 Ω, unbalanced
VSWR	< 3; typ. 2.0
Gain	≥ 0 dBi; typ. 2 dBi; in combination with R&S®AD066FW-K and R&S®FT066F
Input power	max. 600 W CW (depending on beamforming network)
Polarization	linear, vertical
Polarization decoupling	> 18 dB
Connectors	N female
Dimensions (Ø × H) ¹⁾	approx. 1.4 m × 1.5 m (5 ft × 5 ft)
Weight	approx. 150 kg (331 lb)

R&S®FT066F

Dimensions (W × H × L)	approx. 340 mm × 130 mm × 650 mm (13 in × 5 in × 26 in)
Weight	approx. 27 kg (60 lb)

R&S®AD066FW

Connector	N female
MTBF	> 100 000 h
Operating temperature range	-30°C to +70°C
Storage temperature range	-40°C to +70°C
Protection class	IPx6
Max. wind speed	200 km/h (without ice deposit)

¹⁾ Incl. connectors and installation lugs.

Ordering information	Type	Order No.
Broadband VHF/UHF communications antenna system		
Broadband VHF/UHF communications antenna	R&S®AD066F	4090.0000.02
Beamforming network for R&S®AD066F (indoor use)	R&S®FT066F	4090.3500.02
Beamforming network for R&S®AD066F (seawater resistant)	R&S®FT066F	4090.3500.03
Cable sets for R&S®AD066F (model depends on application)	R&S®AD066FW-K	4090.1707.xx

Typical radiation patterns

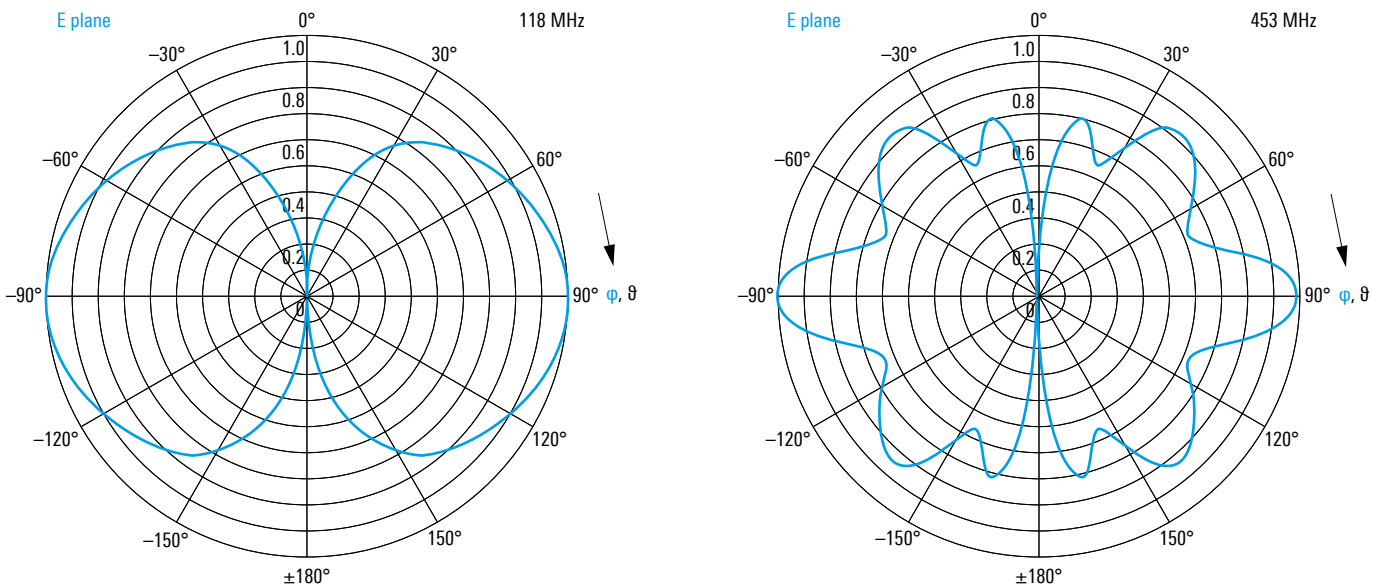

R&S®AD066ST OMNIDIRECTIONAL UHF ANTENNA

225 MHz to 400 MHz

For naval UHF communications



The vertically polarized R&S®AD066ST omnidirectional UHF antenna covers the frequency range from 225 MHz to 400 MHz. Four dedicated receive/transmit systems with up to 200 W transmitter power each can be used with the antenna. Due to the antenna's decoupling characteristics, particularly between its upper and lower part, it can be operated in receive and transmit mode even with close frequencies.

The R&S®AD066ST is characterized by very good omnidirectional characteristics and a high gain.

The antenna's mechanical design is optimized for employment under tough environmental conditions, e.g. on board ships.

Key facts

- ▶ Four individually accessible dipoles
- ▶ High decoupling between individual dipoles
- ▶ For naval applications
- ▶ Ruggedized design for harsh environmental conditions

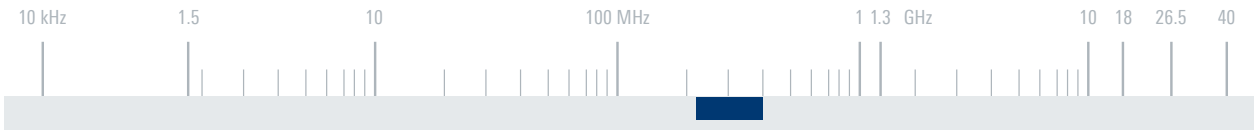

Specifications

Frequency range	225 MHz to 400 MHz	
Polarization	linear, vertical	
Nominal impedance	50 Ω	
VSWR	< 2.5	
Gain	typ. 1.5 dBi	
Polarization decoupling	> 20 dB	
Decoupling	between lower two dipoles	> 27 dB
	between upper two dipoles	> 27 dB
	between lower and upper dipoles	> 40 dB
Radiation pattern	horizontal: omnidirectional	
Maximum input power	4 times 200 W CW	
RF connector	4 N sockets	
MTBF	> 100 000 h	
Operating temperature range	-30°C to +70°C	
Protection class	IP65	
Max. wind speed	without ice deposit	275 km/h
Dimensions	∅ × H	approx. 0.13 m (radome) × 5.4 m (0.4 ft × 18 ft)
Weight	approx. 85 kg (187 lb)	

Ordering information	Type	Order No.
Omnidirectional UHF antenna	R&S®AD066ST	4095.7003.02

Typical VSWR

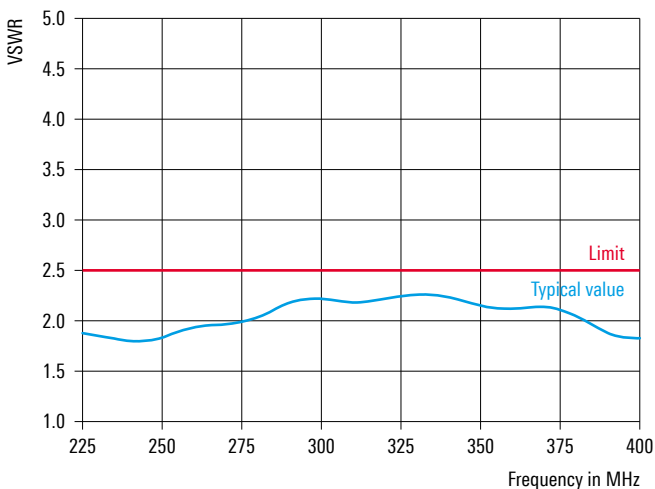

Typical decoupling between a lower (X1 or X2) and an upper dipole (X3 or X4)

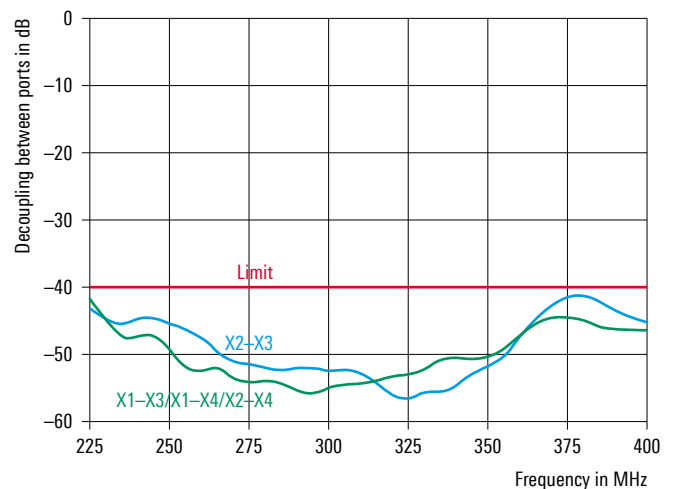

R&S®HK001E UHF COAXIAL DIPOLE

225 MHz to 450 MHz

UHF omnidirectional antenna for vertical polarization



The R&S®HK001E UHF coaxial dipole is a vertically polarized, omnidirectional antenna for fixed and mobile applications, particularly for use on board ships. It is suitable for both transmission and reception.

A mast stub mounted on the dipole's base plate provides a convenient antenna interface for customer applications.

The entire antenna system is splash water resistant.

The antenna can also be fitted upside down, if required.

Key facts

- ▶ Ideal for military aeronautical radio
- ▶ Particularly for use on ships
- ▶ RCS optimized
- ▶ Rugged design
- ▶ Minimal wind load
- ▶ High protection against lightning strikes in the vicinity



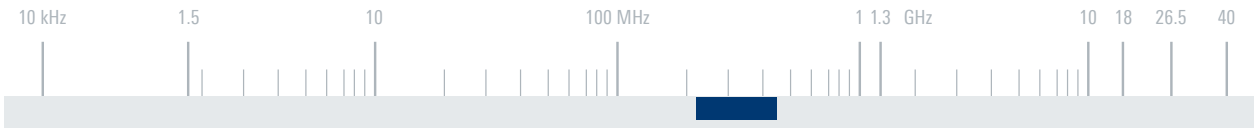

Specifications

Frequency range	225 MHz to 450 MHz	
Polarization	linear/vertical	
Input impedance	50 Ω	
VSWR	≤ 2	
Max. input power	400 W CW	
Gain	typ. 2 dBi	
Horizontal radiation pattern	omnidirectional	
Uncircularity	225 MHz to 400 MHz	typ. ±0.5 dB
	> 400 MHz to 450 MHz	typ. ±1 dB
RF connector	N female	
MTBF	> 100 000 h	
Operating temperature range	-40°C to +70°C	
Protection class	IP65	
Max. wind speed	without ice deposit	275 km/h
Dimensions	Ø × H	approx. 405 mm × 810 mm (16 in × 32 in)
Weight	approx. 3 kg (7 lb)	

Ordering information

Ordering information	Type	Order No.
UHF coaxial dipole, color: squirrel gray (RAL 7000)	R&S®HK001E	4095.1005.02

Recommended extra

Mast, length: 6 m, pluggable	R&S®KM011	0273.9116.02
------------------------------	-----------	--------------

Typical VSWR

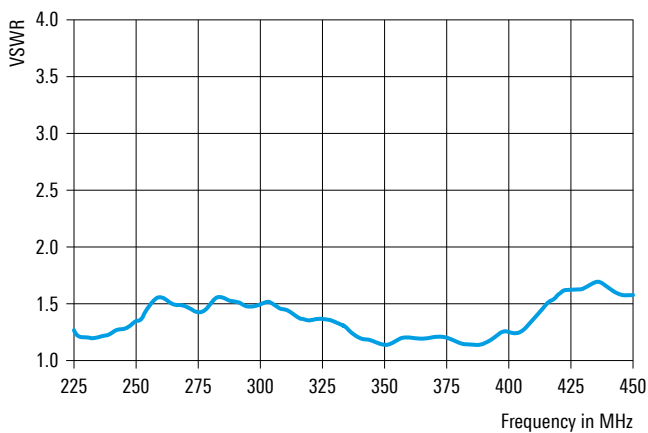

Typical vertical radiation patterns

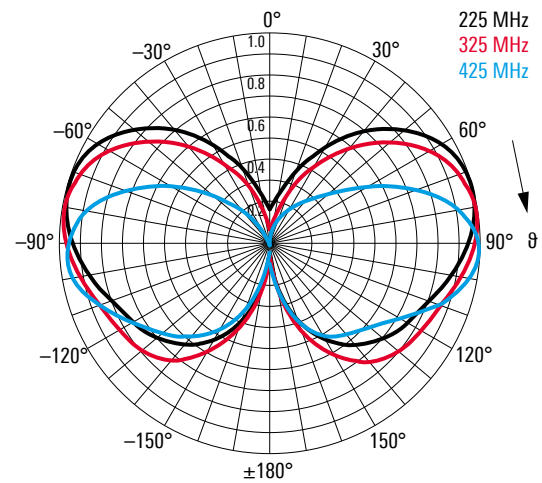

R&S®HK012E VHF COAXIAL DIPOLE

100 MHz to 174 MHz

VHF omnidirectional antenna for vertical polarization



The R&S®HK012E VHF coaxial dipole is a vertically polarized, omnidirectional antenna for fixed and mobile applications, particularly for use on board ships. It is suitable for both transmission and reception.

A mast stub mounted on the dipole's base plate provides a convenient antenna interface for customer applications.

The entire antenna system is splash water resistant.

The antenna can also be fitted upside down, if required.

Key facts

- ▶ Ideal for civil aeronautical radio
- ▶ Particularly for use on ships
- ▶ RCS optimized
- ▶ Rugged design
- ▶ Minimal wind load
- ▶ High protection against lightning strikes in the vicinity



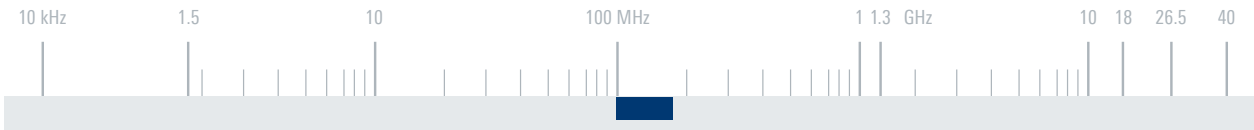

Specifications

Frequency range		100 MHz to 174 MHz
Polarization		linear/vertical
Input impedance		50 Ω
VSWR		≤ 2
Max. input power		400 W CW
Gain		typ. 2 dBi
Horizontal radiation pattern		omnidirectional
Uncircularity		±0.5 dB
RF connector		N female
MTBF		> 100 000 h
Operating temperature range		-40°C to +70°C
Protection class		IP65
Max. wind speed	without ice deposit	275 km/h
Dimensions	Ø × H	approx. 0.5 m × 1.45 m (2 ft × 5 ft)
Weight		approx. 7 kg (15 lb)

Ordering information

Type	Order No.
VHF coaxial dipole, color: squirrel gray (RAL 7000)	R&S®HK012E 4095.3008.02

Recommended extra

Mast, length: 6 m, pluggable	R&S®KM011 0273.9116.02
------------------------------	---------------------------

Typical VSWR

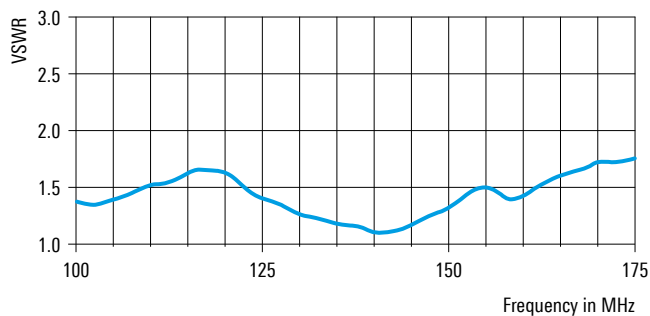

Typical radiation patterns

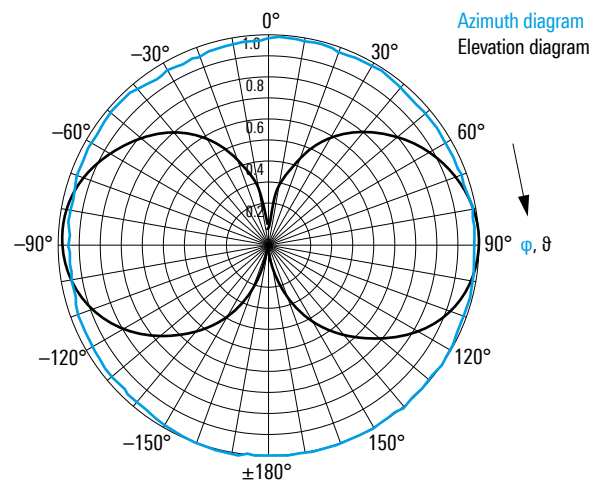

R&S®HK014E

VHF/UHF

COAXIAL DIPOLE

100 MHz to 2 GHz

VHF/UHF omnidirectional antenna for vertical polarization



The R&S®HK014E VHF/UHF coaxial dipole is a vertically polarized, omnidirectional antenna for fixed and mobile applications, particularly for use on board ships. It is suitable for both transmission and reception.

A mast stub mounted on the dipole's base plate provides a convenient antenna interface for customer applications.

The entire antenna system is splash water resistant.

The antenna can also be fitted upside down, if required.

Key facts

- ▶ Extremely wide frequency range
- ▶ High suppression of skin currents
- ▶ Filled-in vertical radiation pattern
- ▶ High protection against lightning strikes in the vicinity
- ▶ Sturdy design
- ▶ RCS optimized
- ▶ Minimal wind load
- ▶ Particularly for use on ships



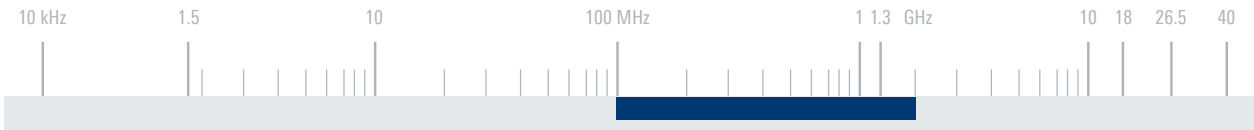

Specifications

Frequency range		100 MHz to 2 GHz
Polarization		linear/vertical
Input impedance		50 Ω
VSWR		< 2
Permissible input power	up to 200 MHz	1000 W CW
	up to 500 MHz	600 W CW
	up to 1.3 GHz	400 W CW
	up to 2 GHz	300 W CW
Gain		typ. 2 dBi
Horizontal radiation pattern		omnidirectional
Uncircularity		±1 dB
Connector		N female
MTBF		> 100 000 h
Operating temperature range		-40°C to +70°C
Protection class		IP65
Max. wind speed	without ice deposit	275 km/h
Dimensions	Ø × H	approx. 0.5 m × 1.4 m (2 ft × 5 ft)
Weight		approx. 15 kg (33 lb)

Ordering information

Ordering information	Type	Order No.
VHF/UHF coaxial dipole, color: squirrel gray (RAL 7000)	R&S®HK014E	4095.5000.02

Recommended extra

Diplexer for the ranges 100 MHz to 174 MHz/ 225 MHz to 450 MHz	R&S®FT224	0525.5117.04
---	-----------	--------------

Typical VSWR

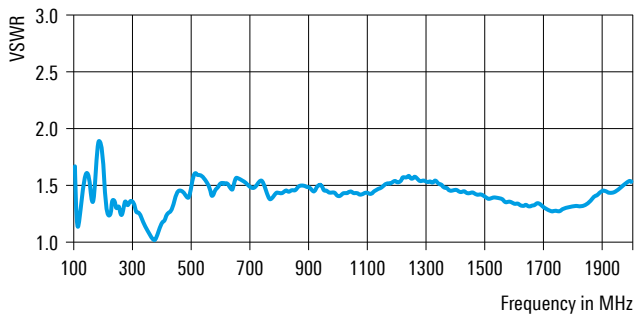

Typical vertical radiation patterns

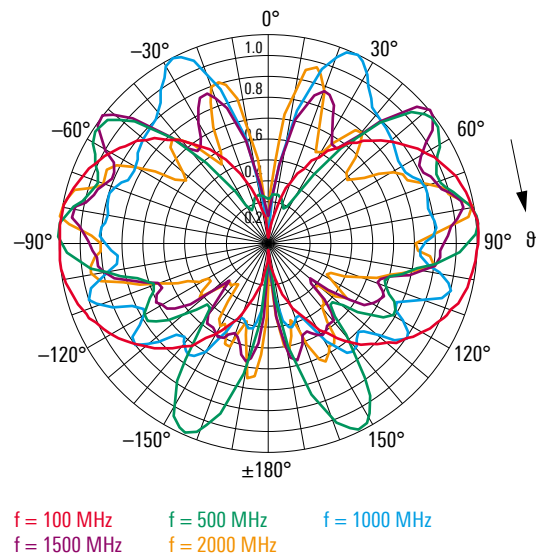

R&S®HK033

VHF/UHF COAXIAL DIPOLE

80 MHz to 2 GHz

Extremely broadband vertical coaxial dipole
especially for use on board ships



The R&S®HK033 VHF/UHF coaxial dipole is a very broadband omnidirectional antenna for vertically polarized signals.

It features a vertical radiation pattern with null fill and high suppression of skin currents on supporting mast and cables.

Its rugged design, low wind load and integrated lightning protection make the R&S®HK033 ideal for use on board ships.

Key facts

- ▶ Extremely broadband
- ▶ Protection against lightning strikes
- ▶ Very low wind load
- ▶ Rugged mechanical design
- ▶ Low weight
- ▶ Ideal for aeronautical radio and monitoring applications

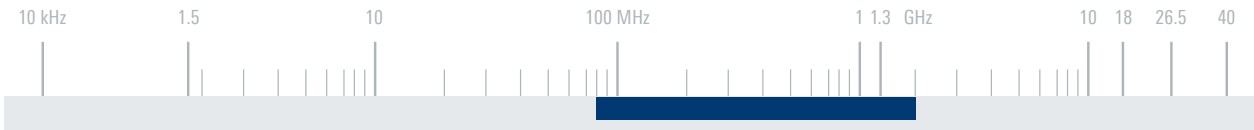

Specifications		
Frequency range		80 MHz to 2 GHz
Polarization		linear/vertical
Input impedance		50 Ω
VSWR		typ. < 2 (see diagram)
Max. input power	100 MHz	860 W + 100 % AM
	400 MHz	430 W + 100 % AM
	600 MHz	360 W + 100 % AM
	1000 MHz	270 W + 100 % AM
	> 1300 MHz	240 W + 100 % AM
Gain		typ. 2 dBi
Horizontal radiation pattern		omnidirectional
Connector		N female
MTBF		> 100 000 h
Operating temperature range		-40 °C to +85 °C
Max. wind speed	without ice deposit	240 km/h
Dimensions	Ø × H	approx. 0.308 m × 1.234 m (1 ft × 4 ft)
Weight		approx. 6 kg (13.2 lb)

Ordering information	Type	Order No.
VHF/UHF coaxial dipole	R&S®HK033	4062.8369.02
Recommended extras		
Diplexer for the ranges from 100 MHz to 162 MHz/225 MHz to 450 MHz	R&S®FT224	0525.5117.03
Mast, length: 6 m, pluggable	R&S®KM011	0273.9116.02
Mast adapter	R&S®KM011Z2	4022.3608.02

Typical VSWR and gain

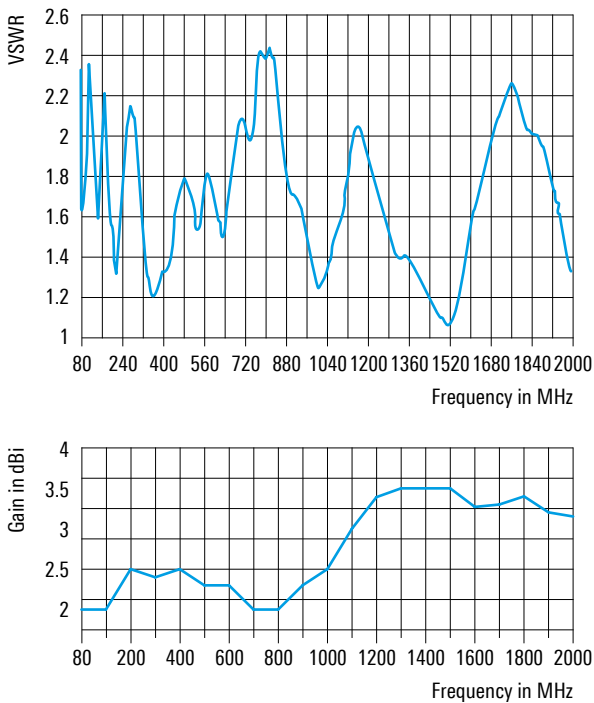

Typical horizontal (top) and vertical (bottom) radiation patterns

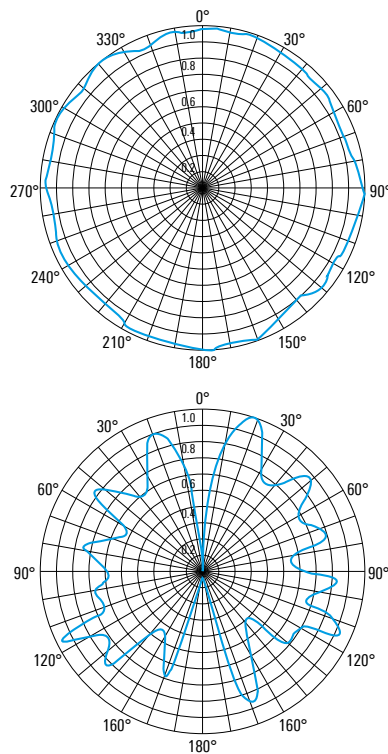

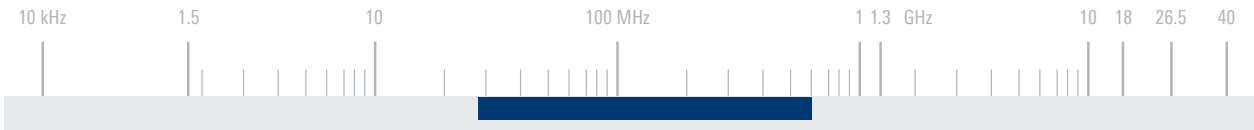

Specifications

Frequency range	27.5 MHz to 600 MHz	
Polarization	vertical	
Input impedance	50 Ω	
VSWR	typ. < 2.5 (measured on a 3 m × 3 m ground plane)	
Gain	27.5 MHz to 110 MHz	-1 dBi to +2 dBi (typ.) (measured on a 3 m × 3 m ground plane)
	110 MHz to 600 MHz	0 dBi to +2 dBi (typ.) (measured under free-space conditions)
Azimuth pattern	omnidirectional	
Max. deviation from circularity	±1 dB	
Elevation pattern	< 110 MHz	monopole-like
	> 110 MHz	dipole-like
Input power	≥ 30 MHz	max. 100 W CW
	< 30 MHz	max. 50 W CW
Connector	N female	
MTBF	> 100 000 h	
Operating temperature range	-40°C to +85°C	
Protection class	IP55	
Max. wind speed	200 km/h	
Dimensions	Ø × L	approx. 165 mm × 1585 mm (7 in × 62 in)
Weight	approx. 12 kg (27 lb)	

Ordering information	Type	Order No.
Omnidirectional broadband antenna	R&S®HK055S1	
Color: sand yellow (RAL 1002)		4067.0443.04
Color: silver gray (RAL 7001)		4067.0443.05
Color: light gray (RAL 7035)		4067.0443.06

**Typical elevation pattern in the E plane at 120 MHz
(measured on a 3 m × 3 m ground plane)**

Typical VSWR characteristic

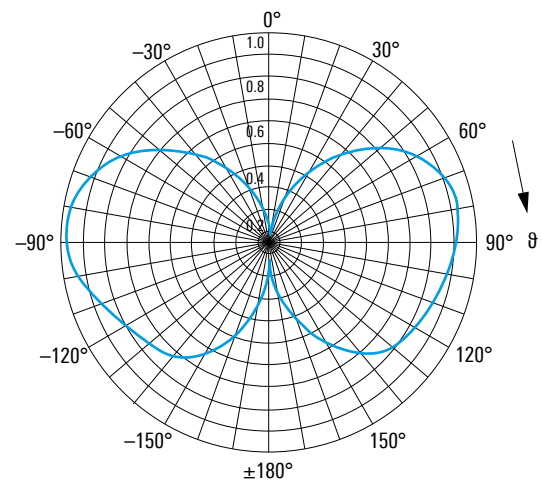
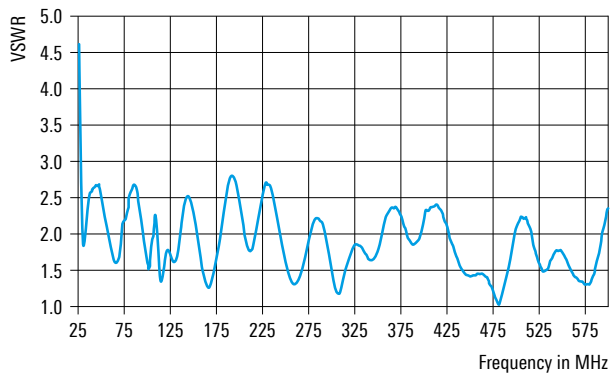

R&S®HK055L1 BROADBAND MOBILE ANTENNA

27.5 MHz to 600 MHz

Compact transmitting/receiving antenna specially designed for operation on vehicles



The R&S®HK055L1 broadband mobile antenna covers the extremely wide frequency range from 27.5 MHz to 600 MHz.

It is designed for mobile transmission and reception in connection with multiband, multirole radios (MMR).

The antenna features outstanding characteristics; no tuning equipment is required, making it ideal for hopping and for multichannel operation.

The antenna is equipped with a spring at its base. If the antenna hits an obstacle, it will bend and automatically return to its vertical position.

Key facts

- ▶ Extremely wide frequency range
- ▶ Compact dimensions
- ▶ High efficiency
- ▶ Rugged design especially for rough handling on board vehicles
- ▶ Wide operating temperature range
- ▶ Especially suitable for multiband multirole radios (MMRs)

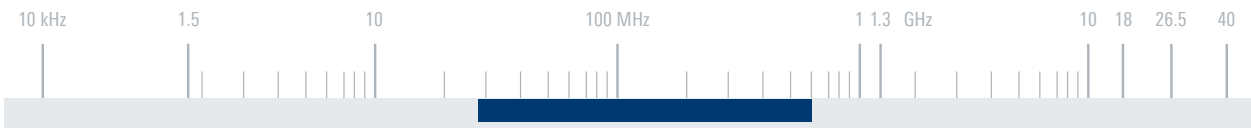

Specifications

Frequency range	27.5 MHz to 600 MHz	
Polarization	vertical	
Input impedance	50 Ω	
VSWR	< 2.5 (measured on a 3 m × 3 m ground plane)	
Gain	27.5 MHz to 110 MHz	-1 dBi to +2 dBi (typ.) (measured on a 3 m × 3 m ground plane)
	110 MHz to 600 MHz	0 dBi to +2 dBi (typ.) (measured under free-space conditions)
Azimuth pattern	omnidirectional	
Max. deviation from circularity	±1 dB	
Elevation pattern	< 110 MHz	monopole-like
	> 110 MHz	dipole-like
Input power	≥ 30 MHz	max. 100 W CW
	< 30 MHz	max. 50 W CW
MTBF	> 100000 h	
Connector	N female	
Operating temperature range	-40°C to +85°C	
Protection class	IP55	
Max. wind speed	200 km/h	
Dimensions	Ø × L	approx. 165 mm × 1585 mm (7 in × 62 in)
Weight	approx. 19 kg (42 lb)	

Ordering information	Type	Order No.
Broadband mobile antenna	R&S®HK055L1	
Color: bronze green (RAL 6031F9)		4067.0014.07
Color: sand yellow (RAL 1002)		4067.0014.05

**Typical elevation pattern in the E plane at 120 MHz
(measured on a 3 m × 3 m ground plane)**

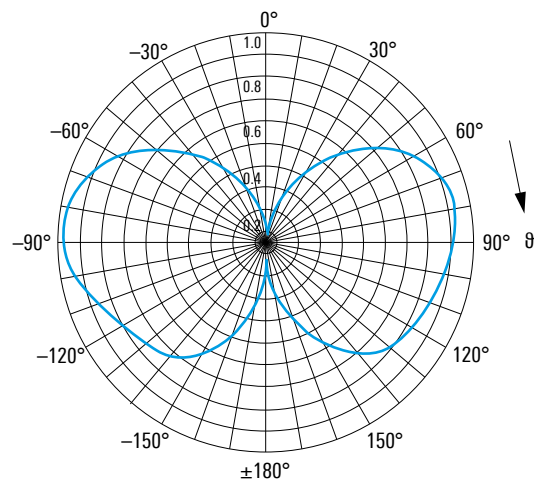

Typical VSWR characteristic

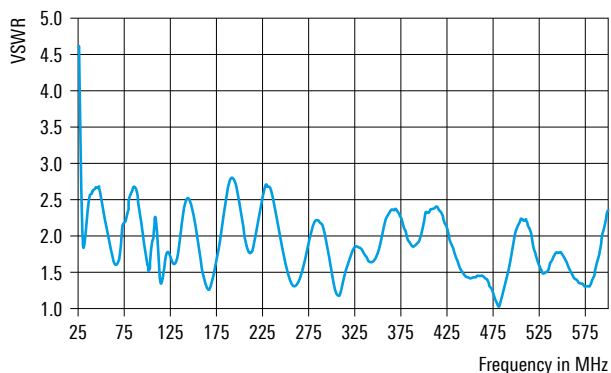

R&S®HK056 BROADBAND MOBILE ANTENNA

600 MHz to 3 GHz

Compact transmitting/receiving antenna specially designed for operation on vehicles



The R&S®HK056 broadband mobile antenna is designed for mobile and semi-stationary communications tasks.

The antenna elements are integrated in a highly weather-resistant radome and are connected to the antenna base via a spring element with a tilt and erect function.

The antenna is installed using a four-hole NATO flange, which provides for easy integration in numerous existing systems.

Key facts

- ▶ Extremely wide frequency range
- ▶ High efficiency
- ▶ Excellent radiation characteristics
- ▶ For use in harsh environments
- ▶ Wide operating temperature range

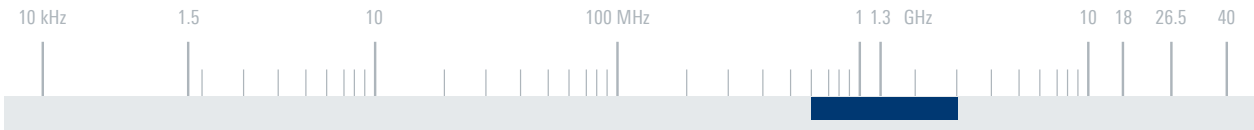

Specifications

Frequency range		600 MHz to 3 GHz
Connector		N female, 50 Ω
VSWR		typ. < 3.0, peaks up to 3.5
Gain		typ. 2 dBi (see diagram)
Polarization		vertical
Azimuth pattern		omnidirectional
Max. deviation from circularity		±1 dB
Elevation pattern		dipole-like
Input power	up to +40°C	100 W CW
	+40°C to +71°C	50 W CW
Protection class		IP67, in line with EN 60529
Operating temperature range		-40°C to +71°C
Dimensions	diameter × length	approx. 46 mm × 968 mm (2 in × 38 in)
	flange diameter	approx. 140 mm (6 in)
Weight		approx. 3.5 kg (8 lb)

Ordering information

Ordering information	Type	Order No.
Broadband mobile antenna, color: bronze green (RAL 6031F9)	R&S®HK056	4067.4403.04

Typical gain

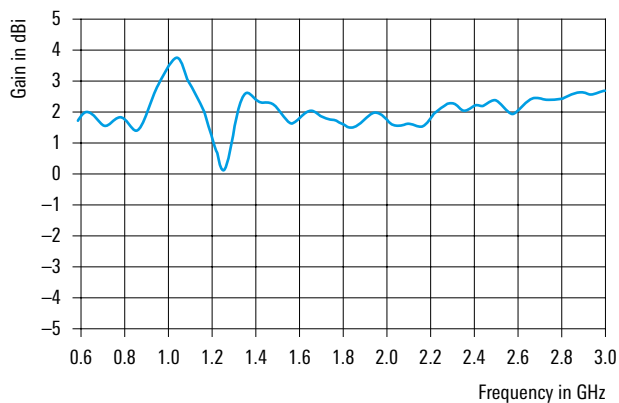

Typical elevation pattern in the E plane at 2 GHz

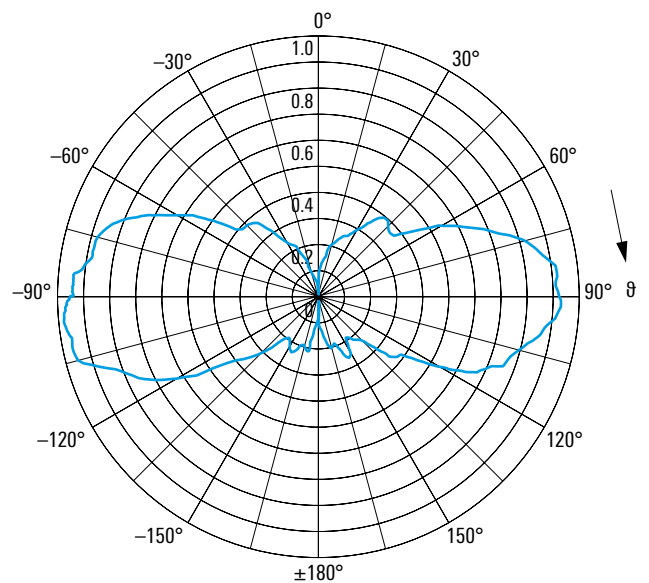

R&S®HK060 BROADBAND MANPACK ANTENNA

30 MHz to 513 MHz

Reliable communications in VHF and UHF frequency bands for manpack radios



The R&S®HK060 broadband manpack antenna is a vertically polarized omnidirectional receive and transmit antenna specially designed for portable radios. Its extremely broad frequency range from 30 MHz to 513 MHz makes it the ideal antenna for multiband, multirole radios (MMR).

The R&S®HK060 is equipped with a highly flexible bending mechanism allowing the antenna to be bent in almost every direction, e.g.:

- ▶ If you pass underneath low overhangs, it bends back and reerects itself automatically
- ▶ If you bend the antenna twice by 180°, the length of the antenna can be reduced to approx. 60 cm for transportation

Key facts

- ▶ Extremely broad frequency range
- ▶ Good form factor
- ▶ Very good radiation characteristics
- ▶ Optimized impedance matching
- ▶ Sturdy construction
- ▶ Foldable for transportation
- ▶ Designed to bend and reerect itself



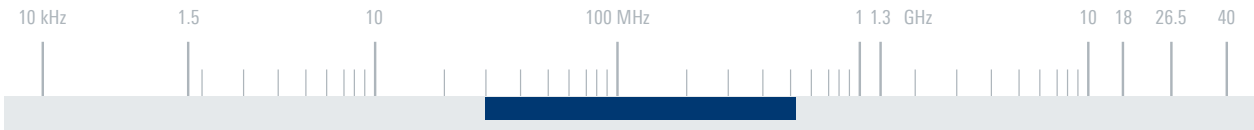

Specifications		
Frequency range		30 MHz to 513 MHz
Input impedance		50 Ω
RF connectors		N male (others on request)
VSWR		typ. < 3
30 MHz to 88 MHz		< 3.5
88 MHz to 175 MHz		< 6.0
175 MHz to 513 MHz		< 3.0
Gain	30 MHz to 88 MHz	typ. -2 dBi
	200 MHz to 513 MHz	typ. 0 dBi
Polarization		linear vertical
Radiation pattern		horizontal: omnidirectional
Maximum input power	30 MHz to 88 MHz	20 W CW
	88 Hz to 400 MHz	15 W CW
	> 400 MHz	10 W CW
MTBF		> 100000 h
Operating temperature range		-40°C to +71°C
Storage temperature range		-50°C to +80°C
Protection class		IP67
Dimensions (∅ × L)	unbent	approx. 35 mm × 1350 mm (1 in × 53 in)
	bent for transportation	approx. 35 mm × 600 mm (1 in × 24 in)
Weight		approx. 0.7 kg (2 lb)

Ordering information	Type	Order No.
Broadband manpack antenna, color: black	R&S®HK060	4075.7008.03

Typical VSWR

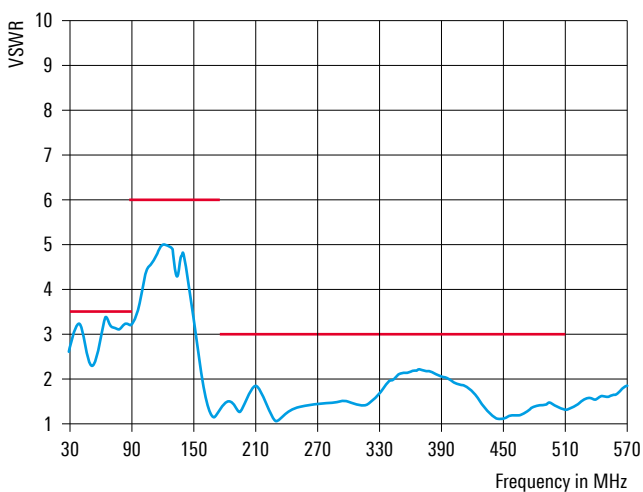

Typical gain

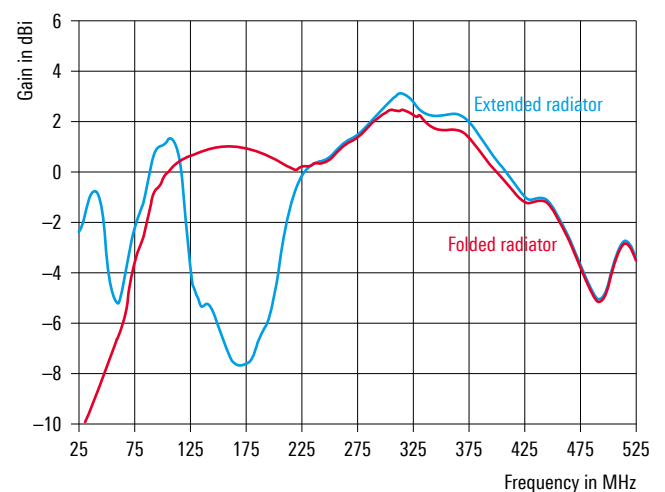

R&S®HK061 VEHICULAR BROADBAND COMMUNICATIONS ANTENNA

30 MHz to 600 MHz

Compact transmitting/receiving antenna specially designed for operation on vehicles



The R&S®HK061 vehicular broadband communications antenna is designed for mobile and semi-stationary communications tasks.

The antenna elements are integrated in a highly ruggedized radome (weather resistant and oak beam test proved) and are connected to the antenna base via a spring element with a tilt and erect function.

The antenna is installed using a four-hole NATO flange, which provides for easy integration in numerous existing systems.

Key facts

- ▶ Extremely wide frequency range
- ▶ Inconspicuous design, favorable form factor
- ▶ High efficiency
- ▶ Excellent radiation characteristics
- ▶ For use in harsh environments
- ▶ Wide operating temperature range
- ▶ Version with integrated GPS antenna available

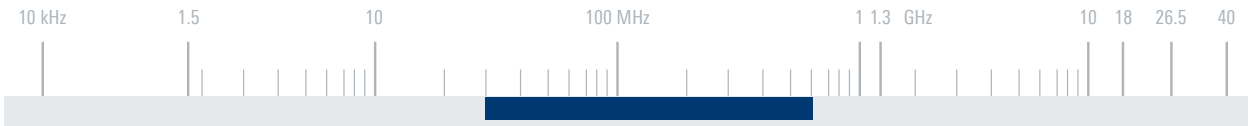

Specifications		
Frequency range	30 MHz to 600 MHz	
Connector	N female, 50 Ω	
VSWR (measured on a 3 m × 3 m ground plane)	typ. < 3.0	
Gain	see diagram	
Azimuth pattern	omnidirectional	
Max. deviation from circularity	±1 dB	
Elevation pattern	< 170 MHz	monopole-like
	> 170 MHz	dipole-like
Input power	up to +50°C	max. 100 W CW
	at +71°C	max. 50 W CW
Protection class	IP67, in line with EN 60529	
Operating temperature range	-40°C to +71°C	
Dimensions	length	approx. 2.2 m (7 ft)
	radome diameter	approx. 40 mm (2 in)
	flange diameter	approx. 140 mm (6 in)
Weight	▶ models .03, .04, .05	▶ approx. 9 kg (20 lb)
	▶ model .13, .14, .15	▶ approx. 10 kg (22 lb)

Ordering information	Type	Order No.
Vehicular broadband communications antenna	R&S®HK061	
Color: bronze green (RAL 6031F9)		4076.0007.05
Color: sand yellow (RAL 1002)		4076.0007.03
Color: squirrel gray (RAL 7000)		4076.0007.04
With integrated GPS antenna, color: sand yellow (RAL 1002)		4076.0007.13
With integrated GPS antenna, color: squirrel gray (RAL 7000)		4076.0007.14
With integrated GPS antenna, color: bronze-green (RAL 6031F9)		4076.0007.15

Typical gain measured on a 3 m × 3 m ground plane in horizontal direction

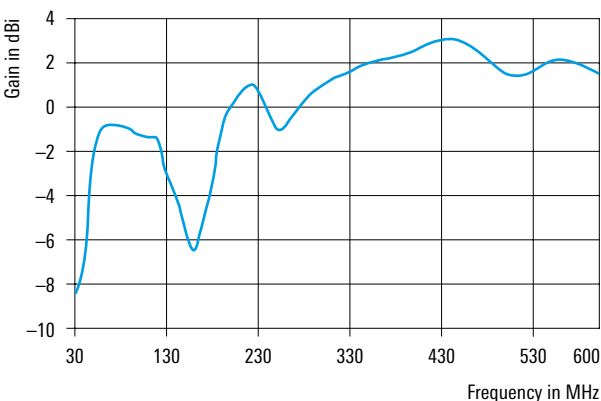

Typical patterns at 200 MHz (measured on a 3 m × 3 m ground plane)

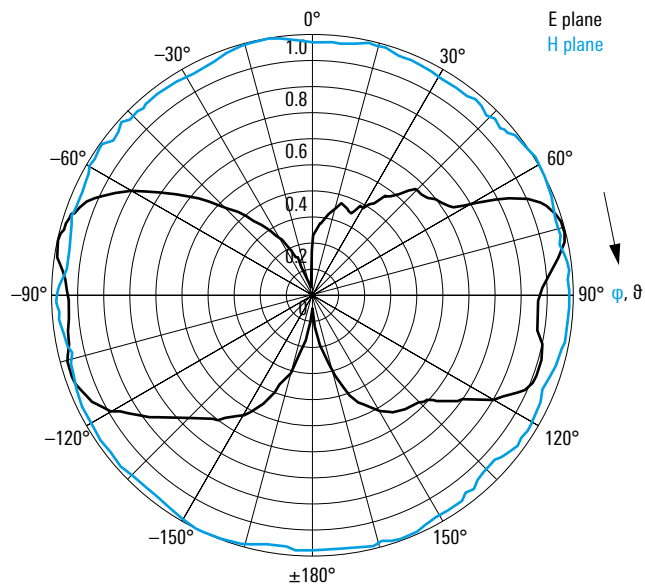

R&S®AU600 ACTIVE OMNIDIRECTIONAL RECEIVING ANTENNA SYSTEM

20 MHz to 8 GHz

For sensitive spectrum monitoring of horizontally and vertically polarized signals



The R&S®AU600 active omnidirectional receiving antenna system is optimized for the reception of linearly polarized signals in the frequency range from 20 MHz to 8 GHz.

Featuring a wide frequency range and simultaneous omnidirectional reception of signals with vertical and horizontal polarization, it is particularly suited for radiomonitoring and radiolocation tasks in stationary and semi-mobile installations.

The antenna system is designed for extreme environmental conditions. Its compact size makes it ideal for locations with limited available space.

Built-in switchable low-noise amplifiers (LNA) and band-stop filters on the integrated switchboard ensure maximum sensitivity and allow the installation even at locations in close vicinity to transmitting antennas.

Key facts

- ▶ Wide frequency range
- ▶ Omnidirectional reception
- ▶ Horizontal and vertical polarization simultaneously
- ▶ Ruggedized design for extreme environmental conditions
- ▶ Integrated switchable low-noise amplifiers and bandstop filters
- ▶ Suitable for installation even at locations close to transmitting antennas



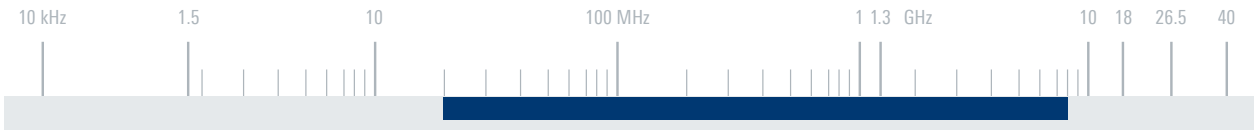

Specifications		
Frequency range		20 MHz to 8 GHz
Polarization		linear vertical and horizontal
Nominal impedance		50 Ω
VSWR		< 2.5; typ. 1.5
Circularity of azimuth pattern	vertical polarization	typ. ±2.5 dB
	horizontal polarization	typ. ±4.5 dB
IP3 in active mode	vertical polarization, f < 0.85 GHz; f ≥ 0.85 GHz	typ. 23 dBm; typ. 22 dBm
	horizontal polarization, f < 0.85 GHz; f ≥ 0.85 GHz	typ. 20 dBm; typ. 23 dBm
IP2 in active mode	vertical polarization, f < 0.85 GHz; f ≥ 0.85 GHz	typ. 44 dBm; typ. 32 dBm
	horizontal polarization, f < 0.85 GHz; f ≥ 0.85 GHz	typ. 37 dBm; typ. 33 dBm
Destructive field strength		> 50 V/m
Stopband attenuation of internal filters	GSM1800/UMTS	typ. 25 dB
	WLAN/LTE band 7	typ. 20 dB
MTBF		> 100000 h
DC power supply	via R&S®OSP-B158 or R&S®OCB600	-12 V (90 mA), +10 V (285 mA), +12 V (550 mA)
Operating temperature range		-40°C to +65°C
Max. wind speed	without ice deposit	275 km/h
	with 30 mm ice deposit	200 km/h
Protection class		IPx5, in line with EN 60529
Dimensions	Ø × L	approx. 0.382 m × 1.015 m (1 ft in × 3 ft)
Weight		approx. 17.5 kg (39 lb)

Ordering information	Type	Order No.
Active omnidirectional receiving antenna system, color: squirrel gray (RAL 7000)	R&S®AU600	4094.6003.02
Recommended extras		
Open switch and control platform, without touchscreen	R&S®OSP-220	1528.3105.02
Open switch and control platform, with touchscreen	R&S®OSP-230	1528.3105.03
R&S®OSP module for R&S®AU600	R&S®OSP-B158	4094.7300.02
Supply and control cable for R&S®AU600 and R&S®OSP-B158, lengths: 10/20/50 m	R&S®AU600-K1	4094.7100.10/20/50
Outdoor control box for R&S®AU600	R&S®OCB600	3059.7400.02

Typical realized gain for vertical polarization

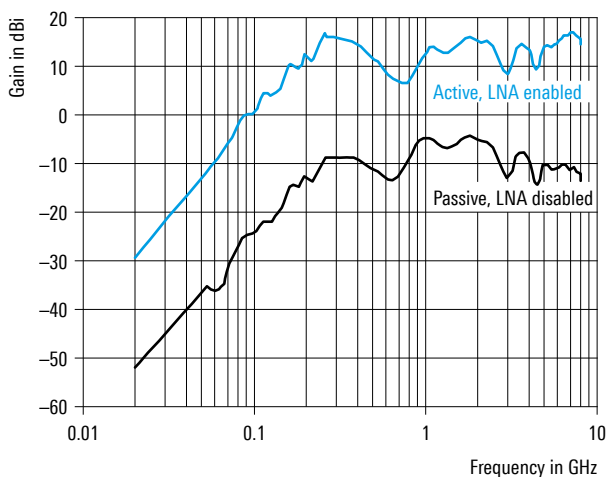

Block diagram of the antenna system

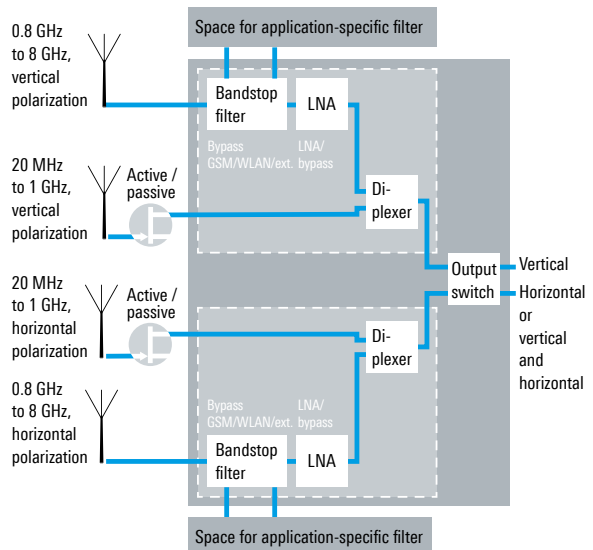

CHAPTER 3

SHF ANTENNAS

Type	Designation	Page
R&S®HE800-PA New	Handheld directional antenna with preamplifier	132
R&S®HF907DC	SHF directional antenna with downconverter	134
R&S®AC005 New	Omnidirectional antenna	136
R&S®AC008	Microwave directional antenna	138
R&S®AC308R2	SHF directional antenna	140
R&S®AC308R3	SHF/EHF directional antenna	142
R&S®AC025DP	Dual-polarized reflector antenna	144
R&S®HL024A1	Crossed log-periodic antennas	146
R&S®HL024S2	Crossed log-periodic antenna	148
R&S®HL024S7	Crossed log-periodic antenna	150
R&S®HL024S8	Crossed log-periodic antenna	152
R&S®HL024S9	Crossed log-periodic antenna	154
R&S®HL050	Log-periodic antennas	156
R&S®HL050S7	Log-periodic directional antenna with preamplifier	158
R&S®HL050E	Log-periodic antenna	160
R&S®AC004R1/R&S®AC004L1	Omnidirectional antennas	162
R&S®AC004R2/R&S®AC004L2	Omnidirectional antennas	164
R&S®HF907OM	Broadband omnidirectional antenna	166
R&S®AD016MC	Compact broadband TX antenna	168
R&S®HF907	Double-ridged waveguide horn antenna	170
R&S®HF918	High-gain SHF antenna	172

R&S®HE800-PA HANDHELD DIRECTIONAL ANTENNA WITH PREAMPLIFIER

18 GHz to 44 GHz

For locating transmitters and interference sources

New



The R&S®HE800-PA handheld directional antenna with pre-amplifier is designated for locating transmitters and interference sources. Bearings are found by manually pointing the antenna in the direction where the signal is strongest.

The antenna is optimized to be used with the R&S®Spectrum Rider FPH handheld spectrum analyzer using the R&S®FPH-B31 spectrum analyzer frequency up-grade option as well as suitable third-party handheld analyzers or receivers.

The R&S®HE800-PA consists of an antenna handle, a fixed antenna module behind the foam radome and an RF and supply cable to the analyzer.

A low-noise amplifier (LNA) is built in to increase system sensitivity.

Key facts

- ▶ Unambiguous direction finding thanks to distinct directional pattern
- ▶ Wide dynamic range
- ▶ Extremely wide frequency range in a compact size
- ▶ Fatigue-free operation due to antenna design and materials used, which keep weight to a minimum
- ▶ Can be mounted on a tripod (1/4" tripod thread)
- ▶ Adapter thread for a smartphone holder, tablet holder or mechanical compass
- ▶ Exchangeable cable set



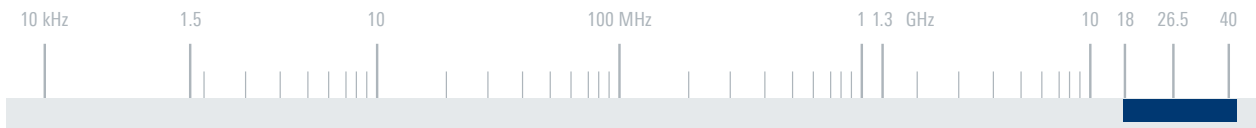

Specifications

Frequency range		18 GHz to 44 GHz
Nominal impedance		50 Ω
Output VSWR		< 2.0
Polarization		linear
Gain		see diagram
Output IP3	18 GHz to 40 GHz	typ. 20 dBm
Output 1 dB compression point		typ. 10 dBm
Input 1 dB compression point		typ. 130 dB μ V/m
Destructive field strength		> 10 V/m
MTBF		> 100000 h
Connector (RF output)		2.92 mm female
Connector (power supply)		USB type A plug
Operating temperature range		-10°C to +55°C
Dimensions	L x H x D	approx. 283 mm x 179 mm x 70 mm (11 in x 7 in x 3 in)
Weight		approx. 0.6 kg (1 lb)

Ordering information

Ordering information	Type	Order No.
Handheld directional antenna with preamplifier	R&S®HE800-PA	4115.6006.02

Recommended extras

Transport case for R&S®HE800-PA	R&S®HE800Z1	4115.7660.02
Tripod, for R&S®HE400 antenna family	R&S®HE400Z4	4104.9109.02
R&S®Spectrum Rider FPH handheld spectrum analyzer, 5 kHz to 26.5 GHz	R&S®FPH	1321.1111.26
Spectrum analyzer frequency upgrade, 26.5 GHz to 31 GHz	R&S®FPH-B31	1321.0780.02

Measured realized gain

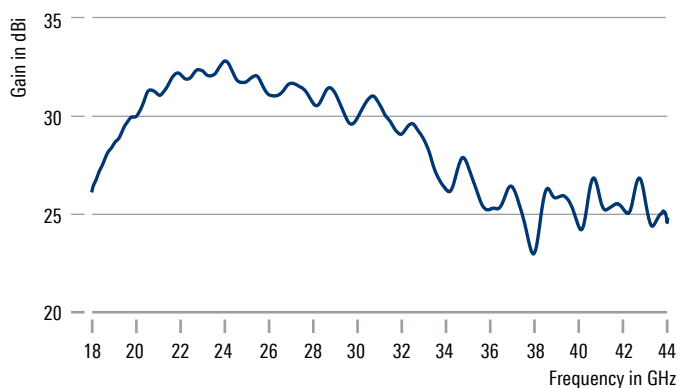

Measured field patterns

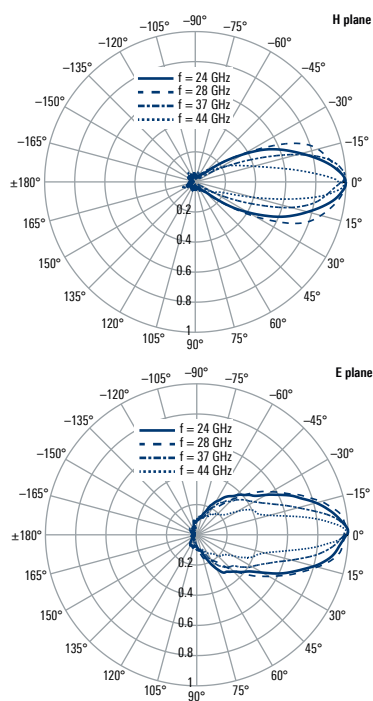

R&S®HF907DC SHF DIRECTIONAL ANTENNA WITH DOWNCONVERTER

7.5 GHz to 18 GHz

Broadband directional antenna with downconverter

For locating transmitters and interference sources
when used with a portable receiver (e.g. the
R&S®PR100 portable receiver)



The R&S®HF907DC consists of a downconverter and an antenna fixed to it. In order to detect signal sources, the R&S®HF907DC must be connected to a receiver (e.g. the R&S®PR100 portable receiver).

Signal bearings are obtained by manually pointing the antenna in the direction of maximum field strength.

The operating frequency range is downconverted to the range below 7.5 GHz in two switchable frequency bands. Preselection filters for each frequency band suppress image frequency and IF breakthrough.

The interface and display panel contains all display and control elements and connectors and provides access to the battery compartment.

A version without integrated antenna is also available. It provides an RF input for connecting an external antenna.

Key facts

- ▶ Manual polarization switching (horizontal, vertical, 45°)
- ▶ Distinct directional pattern
- ▶ Battery operation for portable applications
- ▶ Automatic frequency switching (when used with the R&S®PR100)
- ▶ Excellent suppression of image frequency and IF breakthrough by means of switchable preselection filters



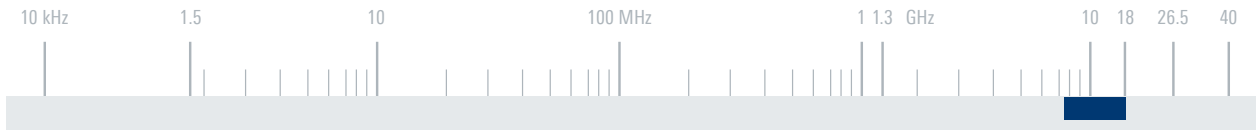

Specifications

Frequency range		7.5 GHz to 18 GHz
Input frequency range	band 1; band 2	7.5 GHz to 12.5 GHz; 12.5 GHz to 18 GHz
Intermediate frequency range	band 1; band 2	6.5 GHz to 1.5 GHz; 7.5 GHz to 2 GHz
Antenna polarization		horizontal, vertical or 45°, manually adjustable
Nominal impedance		50 Ω
VSWR	IF Out; ANT In	typ. < 2.5; < 3.5 (meas.; model .03 only)
Connector	IF Out; ANT In	N female; SMA female (model .03 only)
Frequency accuracy		< 25 kHz
Image frequency rejection		> 45 dB (meas.)
IF breakthrough	band 1; band 2	> 45 dB (meas.); > 55 dB (meas.)
Antenna gain (model .04 only)		8 dBi (meas.)
Conversion gain of downconverter	band 1; band 2	typ. 36 dB; typ. 34 dB
MTBF	excluding battery	> 75 000 h
Max. permissible field-strength	model .04 only	3 V/m
Max. input power	model .03 only	-17 dBm
Permissible temperature range		-10°C to +50°C
Dimensions (W × L × D)	model .03/ model .04	approx. 150 × 300 × 135 mm (6 × 12 × 5 in)/ approx. 150 × 355 × 175 mm (6 × 14 × 7 in)
Weight	model .03/model .04	approx. 3.2 kg (7 lb)/3.5 kg (8 lb)

Ordering information

Ordering information	Type	Order No.
SHF directional antenna with downconverter	R&S®HF907DC	4070.8006.04
SHF downconverter	R&S®HF907DC	4070.8006.03

Recommended extras

Portable receiver	R&S®PR100	4079.9011.02
Battery pack	R&S®HF907DC-BP	4079.3507.02
External battery charger	R&S®HF907DC-CH	4079.3707.02
Cable set	R&S®HF907DC-K1	4070.8958.02
Tripod adapter	R&S®HF907DC-Z1	4079.3113.02
Carrying case	R&S®HF907DC-Z2	4079.3207.02

Typical E field and H field patterns

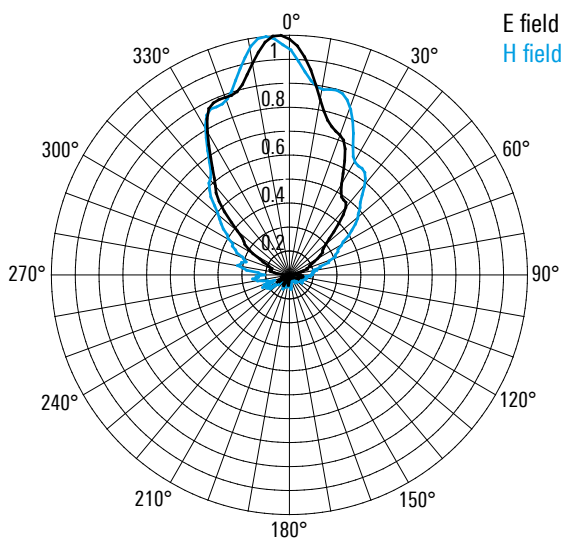

R&S®AC005 OMNIDIRECTIONAL ANTENNA

500 MHz to 40 GHz

For wideband monitoring and measuring applications

New



The R&S®AC005 omnidirectional antenna covers the extremely wide frequency range from 0.5 GHz to 40 GHz in a two dipole stacked configuration. The lower antenna operates from 0.5 GHz to 18 GHz and the upper antenna covers the frequency range from 18 GHz to 40 GHz.

The R&S®AC005 is designed for slant polarization. Horizontal, vertical and circular polarized signals can be received simultaneously.

The key functions as a receiving antenna are wideband monitoring and measuring with good sensitivity, e.g. for coverage measurements and for interference hunting. As a transmitting antenna, the R&S®AC005 is designed to transmit low-power signals (e.g. to measure EMI immunity and to emit test signals).

Due to its sturdy design, the R&S®AC005 can be used for naval applications as well.

Key facts

- ▶ Extremely wide frequency range
- ▶ High efficiency
- ▶ Compact dimensions
- ▶ Robust design – ideal for use on board vehicles



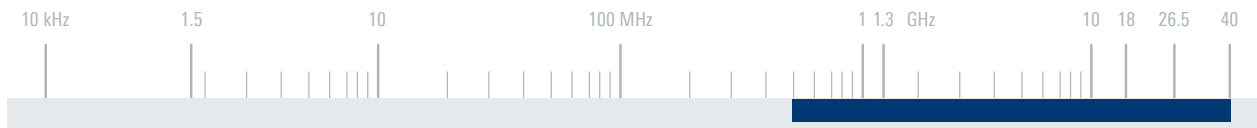

Specifications

Frequency range	500 MHz to 40 GHz	
Polarization	linear, slant	
Input impedance	50 Ω	
VSWR	see diagram	
Gain	0.6 GHz to 18 GHz	0 dBi to 5 dBi (typ.)
	18 GHz to 40 GHz	typ. 0 dBi
Uncircularity	typ. ± 2 dB	
Max. input power	14 W at +25°C	
RF connectors	0.5 GHz to 18 GHz	N female
	18 GHz to 40 GHz	K (2.92) female
Operating temperature range	-40°C to +65°C	
Protection class	IPx6, waterproof	
Max. wind speed	without ice deposit	275 km/h
	with 30 mm radial ice deposit	180 km/h
Dimensions	$\varnothing \times H$	approx. 400 mm \times 410.5 mm (15.8 in \times 16.2 in)
Weight	approx. 9 kg (19.8 lb)	

Ordering information

Ordering information	Type	Order No.
Omnidirectional antenna	R&S®AC005	4113.3000.02
Recommended extra		
Outdoor antenna amplifier	R&S®OAA1840	3065.5506.02

Typical VSWR

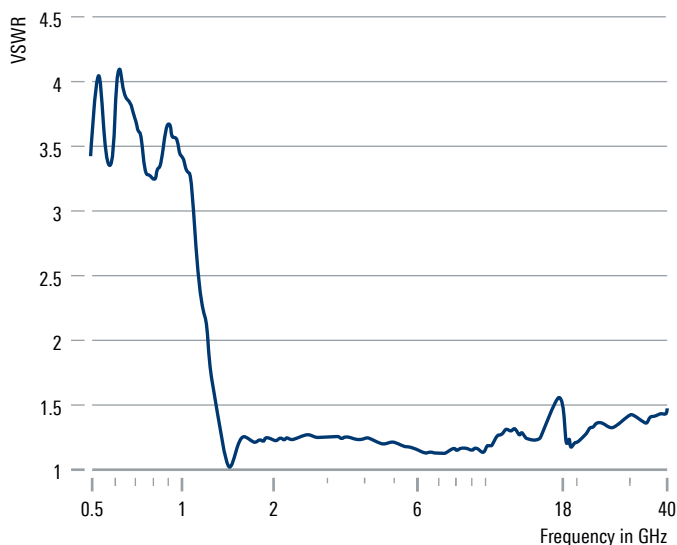

R&S®AC008 MICROWAVE DIRECTIONAL ANTENNA

1 GHz to 18 GHz/0.85 GHz to 26.5 GHz

Manually or automatically adjustable directional antenna for the detection of RF signals and for field strength measurements



The R&S®AC008 is a manually adjustable directional antenna for mobile applications.

When used with the R&S®RD016 antenna rotator and the R&S®GB016 control unit, the R&S®AC008 can also be automatically positioned in azimuth and elevation.

The reflector has a diameter of 0.9 m and – depending on the feed used – receives signals in the range from 1 GHz to 18 GHz or from 0.85 GHz to 26.5 GHz.

The R&S®AC008 is used for detecting radio signals and for field strength measurements. It can also be directed toward geostationary satellites.

The use of different feeds allows reception of any type of polarization. For transportation, the directional antenna (including the feed) can be collapsed to a handy size.

Key facts

- ▶ Wide frequency range
- ▶ Reception of linear, dual-linear and circular polarization (depending on feed used)
- ▶ Collapsible for easy transport
- ▶ Use of active feeds to compensate cable loss possible



R&S®AC008 with R&S®RD016 antenna rotator and R&S®GB016 control unit.

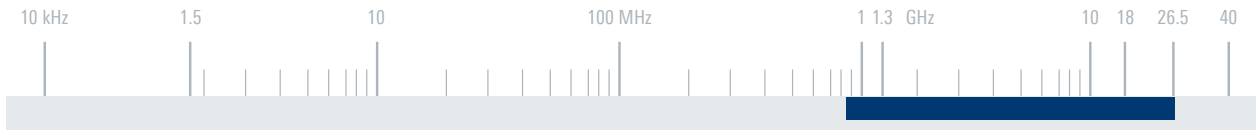

Specifications

Frequency range	models .02/.04	1 GHz to 18 GHz
	model .05	0.85 GHz to 26.5 GHz
Polarization with feed	model .02, R&S®HL024A1	dual-linear
	model .05, R&S®HL050	linear
	model .04, R&S®HL024S2	linear/circular
Input impedance		50 Ω
VSWR		depending on feed
Gain		15 dBi to 40 dBi (1 GHz to 18 GHz)
Half-power beamwidth		19° to 1.1° (1 GHz to 18 GHz)
Positioning range	azimuth	360°
	elevation	-6° to +44°
Connector		SMA female
MTBF		> 100 000 h
Operating temperature range		-30°C to +50°C
Reflector diameter		approx. 0.9 m (35 in)
Weight		approx. 12 kg (27 lb)

Ordering information

Ordering information	Type	Order No.
Microwave directional antenna	R&S®AC008	
1 GHz to 18 GHz, dual-linear polarization		0671.5017.02
1 GHz to 18 GHz, linear/circular polarization		0671.5017.04
0.85 GHz to 26.5 GHz, linear polarization		0671.5017.05
Recommended extras		
Tripod	R&S®AC008-Z	0671.5117.02
Control unit	R&S®GB016	4056.7006.03
Control cable, length: 10 m	R&S®GB016Z1	4056.7270.02
Microwave cable, length: 5 m	R&S®AC008W2	0751.6931.04
Microwave cable, length: 10 m	R&S®AC008W2	0751.6931.05
Telescope	R&S®AC008F1	0751.6919.02
Antenna rotator	R&S®RD016	4077.9008.02
Control cable, between R&S®GB016 and R&S®RD016, length: 10 m	R&S®GK016K1	4077.9150.00
High-resolution elevation adjustment upgrade kit	R&S®AC008-AZ	4061.2173.00

Typical gain (blue) and half-power beamwidth (black) of R&S®AC008 with R&S®HL050 feed

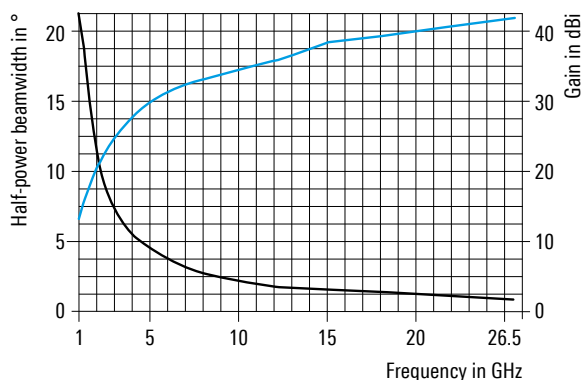

R&S®AC008 with R&S®AC008-AZ high-resolution elevation adjustment upgrade kit.

R&S®AC308R2 SHF DIRECTIONAL ANTENNA

18 GHz to 26.5 GHz

Broadband directional antenna for radiomonitoring



The R&S®AC308R2 SHF directional antenna for the frequency range from 18 GHz to 26.5 GHz has a reflector diameter of 25 cm.

The antenna is supplied with an integrated preamplifier (model .02) or without a preamplifier (model .04).

The R&S®AC308R2 with optional tripod, adapter and power supply can be operated independently.

Key facts

- ▶ Wide frequency range
- ▶ Fast and simple installation
- ▶ Rugged design



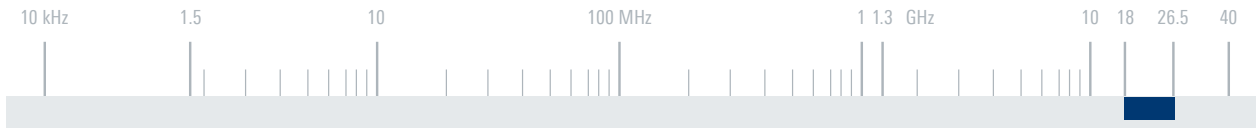

Specifications

Antenna

Frequency range	18 GHz to 26.5 GHz
Polarization	H, V or 45°, depending on installation
Input impedance	50 Ω
VSWR	< 3
Gain	30 dBi to 33 dBi
Half-power beamwidth	4.5° to 3°
Reflector diameter	250 mm
Connector	K female

Preamplifier (typical values)

Gain	> 28 dB	
1 dB compression point	≥ +10 dBm	
Noise figure	< 3 dB	
Power consumption	+15 V/0.2 A	
MTBF	model .04 (passive) model .02 (active)	> 100 000 h > 100 000 h
Operating temperature range	-20°C to +50°C	
Dimensions	L × Ø	approx. 380 mm × 300 mm (15 in × 12 in)
Weight		approx. 4 kg (9 lb)

Ordering information	Type	Order No.
SHF directional antenna	R&S®AC308R2	
With preamplifier, 18 GHz to 26.5 GHz		4051.6001.02
Without preamplifier, 18 GHz to 26.5 GHz		4051.6001.04
Recommended extras		
Power supply	R&S®IN308	4059.6752.02
Transit case	R&S®AC308Z	4059.6500.02
Adapter for R&S®HZ-1	R&S®KA308R2	4057.8606.00
Wooden tripod	R&S®HZ-1	0837.2310.02

Typical antenna gain

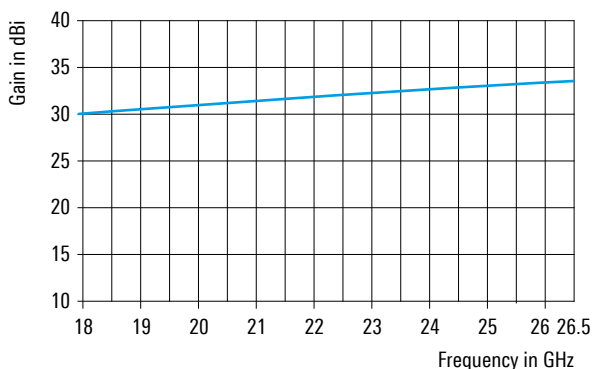

Typical radiation pattern at 26.5 GHz

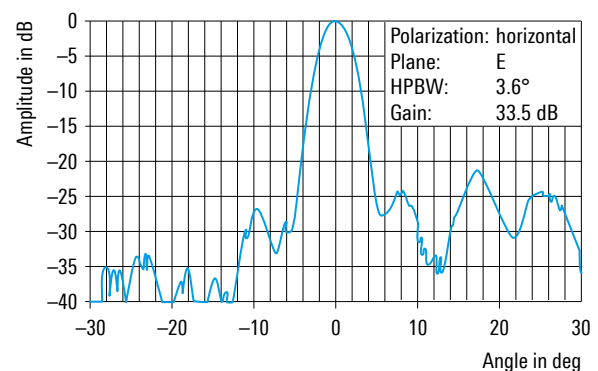

R&S®AC308R3 SHF/EHF DIRECTIONAL ANTENNA

26.5 GHz to 40 GHz

Broadband directional antenna for radiomonitoring



The R&S®AC308R3 SHF/EHF directional antenna for the frequency range from 26.5 GHz to 40 GHz has a reflector diameter of 25 cm.

The antenna is supplied with an integrated preamplifier (model .02) or without a preamplifier (model .04).

The R&S®AC308R3 with optional tripod, adapter and power supply can be operated independently.

Key facts

- ▶ Wide frequency range
- ▶ Fast and simple installation
- ▶ Rugged design



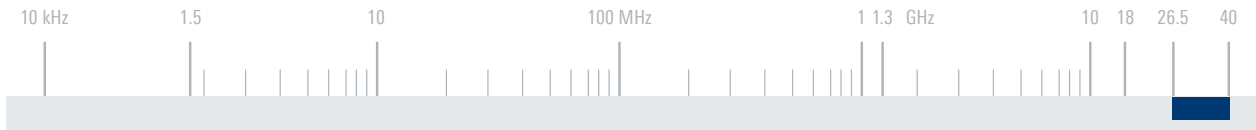

Specifications

Antenna

Frequency range	26.5 GHz to 40 GHz	
Polarization	H, V or 45°, depending on installation	
Input impedance	50 Ω	
VSWR	< 3	
Gain	33 dBi to 36 dBi	
Half-power beamwidth	3° to 2°	
Reflector diameter	250 mm	
Connector	K female	

Preamplifier (typical values)

Gain	> 30 dB	
1 dB compression point	≥ +10 dBm	
Noise figure	< 4 dB	
Power consumption	+15 V/0.2 A	
MTBF	model .04 (passive)	> 250 000 h
	model .02 (active)	> 100 000 h
Operating temperature range	-20°C to +50°C	
Dimensions	L × Ø	approx. 380 mm × 300 mm (15 in × 12 in)
Weight	approx. 4 kg (9 lb)	

Ordering information	Type	Order No.
SHF/EHF directional antenna	R&S®AC308R3	
With preamplifier, 26.5 GHz to 40 GHz		4051.6253.02
Without preamplifier, 26.5 GHz to 40 GHz		4051.6253.04
Recommended extras		
Power supply	R&S®IN308	4059.6752.02
Transit case	R&S®AC308Z	4059.6500.02
Adapter for R&S®HZ-1	R&S®KA308R2	4057.8606.00
Wooden tripod	R&S®HZ-1	0837.2310.02

Typical antenna gain

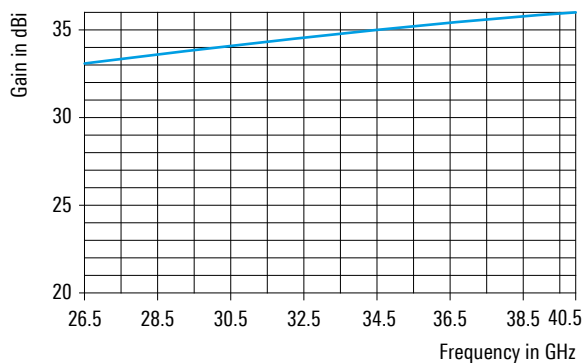

Typical radiation pattern at 40 GHz

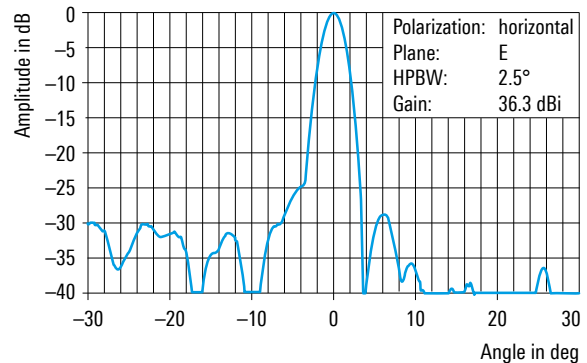

R&S®AC025DP DUAL-POLARIZED REFLECTOR ANTENNA

18 GHz to 40 GHz

Broadband microwave reflector antenna
with preamplifier



The R&S®AC025DP dual-polarized reflector antenna has been optimized for use in the range from 18 GHz to 40 GHz.

For independent operation, the antenna is installed on a tripod.

The antenna is equipped with two integrated preamplifiers for simultaneous signal processing.

Key facts

- ▶ Extremely wide frequency range
- ▶ Simultaneous reception of two orthogonal polarization planes
- ▶ Fast and simple installation
- ▶ Sturdy mechanical design



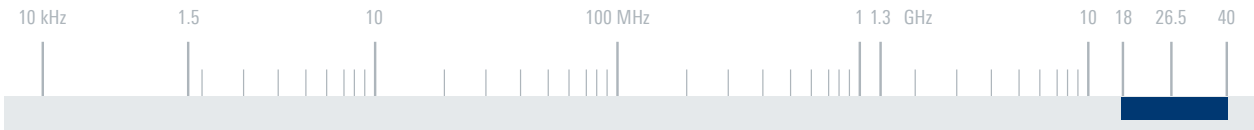

Specifications

Antenna

Frequency range		18 GHz to 40 GHz
Polarization		2 × linear (orthogonal to each other)
Input impedance		50 Ω
VSWR (with preamplifier)		< 3.0; typ. < 2.5
Gain		26 dBi to 32 dBi
Half-power beamwidth		4.5° to 2° (typ.)
Reflector diameter		250 mm
Connector		2 × K female

Preamplifier (typical values)

Gain		min. 28 dB
1 dB compression point		> 5 dBm
Noise figure		max. 5 dB
Power consumption		15 V/0.5 A (max.)
MTBF		> 50 000 h
Operating temperature range		-30°C to +55°C
Dimensions	Ø × L	approx. 320 mm × 340 mm (13 in × 13 in)
Weight		approx. 5 kg (11 lb)

Ordering information

Ordering information	Type	Order No.
Dual-polarized reflector antenna	R&S®AC025DP	4062.5830.02

Recommended extras

Power supply	R&S®IN308	4059.6752.02
Adapter for R&S®HZ-1	R&S®KA308R2	4057.8606.00
Wooden tripod	R&S®HZ-1	0837.2310.02

Typical antenna gain

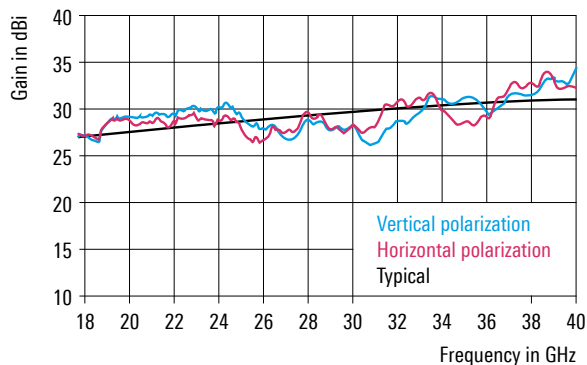

Typical radiation patterns at 33 GHz

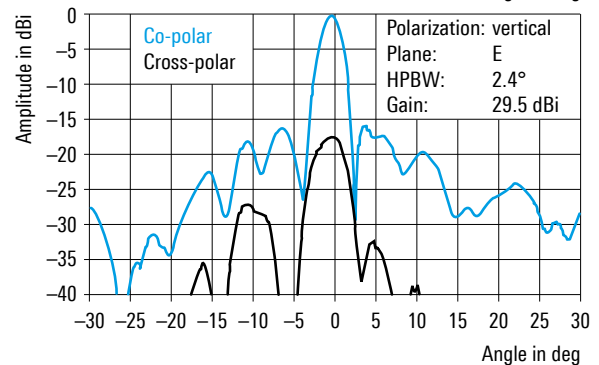
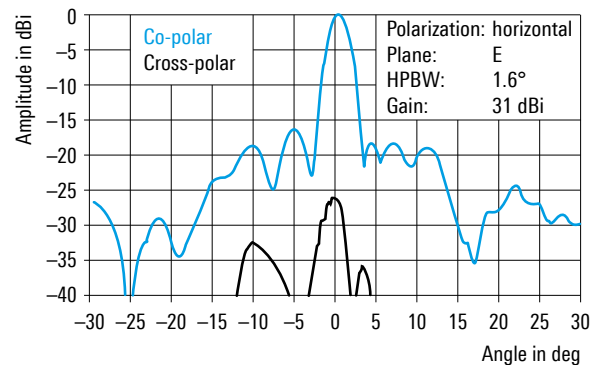

R&S®HL024A1 CROSSED LOG- PERIODIC ANTENNA

1 GHz to 18 GHz

Log-periodic directional antenna for simultaneous reception of horizontally and vertically polarized waves



The R&S®HL024A1 crossed log-periodic antenna is designed for simultaneous reception of horizontally and vertically polarized waves.

It can also be used as a transmitting antenna for low power and as a feed for the R&S®AC008 microwave directional antenna.

Key facts

- ▶ Horizontal and vertical polarization
- ▶ Wide frequency range
- ▶ Virtually frequency-independent radiation pattern
- ▶ Usable as a feed for R&S®AC008 microwave directional antenna
- ▶ Individual calibrations in line with ANSI C63.5 and CISPR 16-1-6
- ▶ Accredited calibration available on request



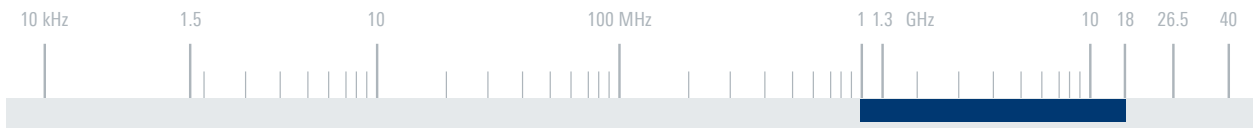

Specifications		
Frequency range		1 GHz to 18 GHz
Polarization		linear/horizontal and vertical
Input impedance		50 Ω
VSWR		≤ 2.5
Max. input power		9 W to 2.5 W CW
Gain		typ. 7 dBi
Connector		2 × SMA female
Operating temperature range		-30°C to +55°C
Max. wind speed	without ice deposit	180 km/h
MTBF		> 100000 h
Dimensions	Ø × H; with radome	approx. 210 mm × 300 mm (8 in × 12 in)
Weight		approx. 0.7 kg (2 lb)

Ordering information	Type	Order No.
Crossed log-periodic antenna	R&S®HL024A1	0650.7510.03
Recommended extras		
Microwave cable, length: 5 m	R&S®AC008W2	0751.6931.04
Microwave cable, length: 10 m	R&S®AC008W2	0751.6931.05
Adapter for R&S®HZ-1	R&S®HL025Z1	4053.4006.03
Wooden tripod	R&S®HZ-1	0837.2310.02

Typical gain

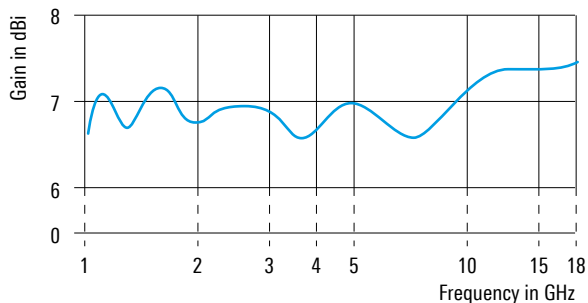

Typical radiation patterns

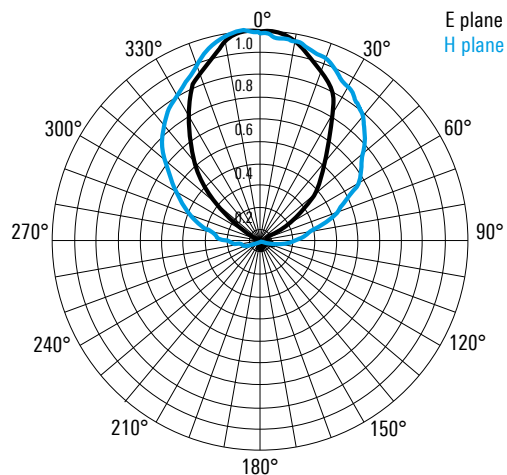

R&S®HL024S2 CROSSED LOG- PERIODIC ANTENNA

1 GHz to 18 GHz

Log-periodic directional antenna consisting of the R&S®HL024A1 and a passive polarization switching network



The R&S®HL024S2 crossed log-periodic antenna can be used for waves with horizontal, vertical, left-hand or right-hand circular polarization.

It consists of the R&S®HL024A1 antenna and a polarization switching network. Polarization can be selected by remote control using e.g. the R&S®GB016.

The R&S®HL024S2 can also be used as a feed for the R&S®AC008 microwave directional antenna.

Key facts

- ▶ Horizontal, vertical, left-hand or right-hand circular polarization
- ▶ Wide frequency range
- ▶ Virtually frequency-independent radiation pattern
- ▶ Remote controlled polarization selection with optional R&S®GB016 control unit
- ▶ Usable as a feed for R&S®AC008 microwave directional antenna



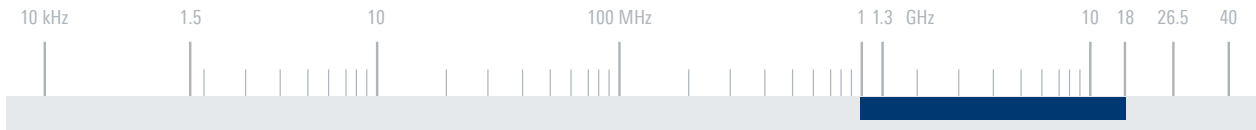

Specifications

Frequency range		1 GHz to 18 GHz
Polarization		horizontal, vertical, left-hand or right-hand circular (selectable)
Input impedance		50 Ω
VSWR		< 3
Max. input power		9 W to 2.5 W CW
Antenna gain	linear	typ. 6 dBi
	circular	typ. 5 dBi
Power supply		12 V DC, 1 A
Connector		SMA female
Control connector		10-contact, round, male
Operating temperature range		-30°C to +55°C
Max. wind speed	without ice deposit	180 km/h
MTBF		> 100000 h
Dimensions	∅ × H; with radome	approx. 210 mm × 353 mm (8 in × 14 in)
Weight		approx. 1.7 kg (4 lb)

Ordering information

Ordering information	Type	Order No.
Crossed log-periodic antenna	R&S®HL024S2	4052.1003.02

Recommended extras

Control unit	R&S®GB016	4056.7006.03
Control cable, length: 10 m	R&S®GB016Z1	4056.7270.02
Microwave cable, length: 5 m	R&S®AC008W2	0751.6931.04
Microwave cable, length: 10 m	R&S®AC008W2	0751.6931.05
Adapter for R&S®HZ-1	R&S®HL025Z1	4053.4006.03
Wooden tripod	R&S®HZ-1	0837.2310.02
Module for R&S®OSP, for controlling R&S®HL024Sx and R&S®HL050S7	R&S®OSP-BS016	4118.6007.03
Open switch and control platform, without touchscreen	R&S®OSP-220	1528.3105.02
Open switch and control platform, with touchscreen	R&S®OSP-230	1528.3105.03

Typical gain

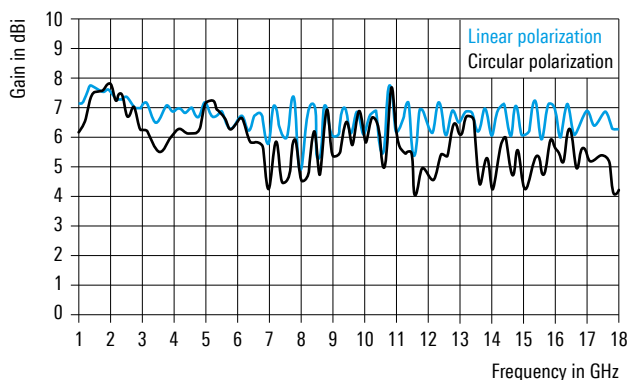

Typical radiation patterns (linear polarization)

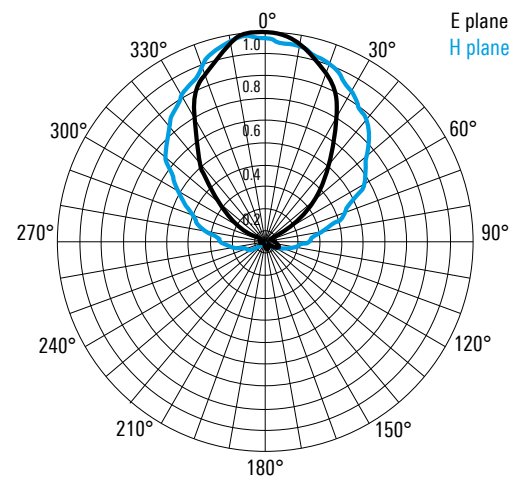

R&S®HL024S7 CROSSED LOG- PERIODIC ANTENNA

1 GHz to 18 GHz

Log-periodic directional antenna consisting of the R&S®HL024A1 and a broadband preamplifier for horizontal or vertical polarization (selectable)



The R&S®HL024S7 consists of the R&S®HL024A1 crossed log-periodic antenna and a broadband preamplifier. It is suitable for the reception of linearly polarized waves.

Horizontal or vertical polarization can be selected.

The preamplifier can be optionally switched on. It prevents a significant reduction in S/N due to loss in RF cables connecting the antenna to a receiver.

The antenna can also be used as a feed for the R&S®AC008 microwave directional antenna.

Key facts

- ▶ Wide frequency range
- ▶ Selectable broadband preamplifier
- ▶ Selectable horizontal or vertical polarization
- ▶ No reduction in S/N due to the use of a low-noise amplifier at the antenna output
- ▶ Usable as a feed for R&S®AC008 microwave directional antenna



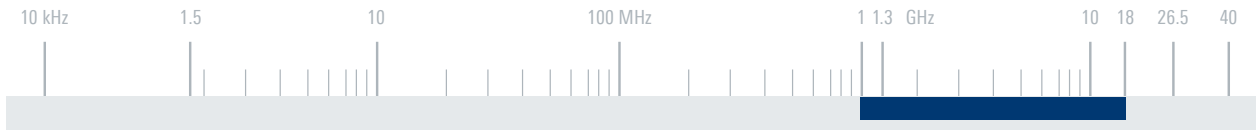

Specifications

Frequency range	1 GHz to 18 GHz	
Polarization	horizontal or vertical (selectable)	
Input impedance	50 Ω	
VSWR	< 3	
Antenna gain (passive)	typ. 6 dBi	
Noise figure	max. 3.6 dB	
Realized gain (active)	typ. 36 dB	
1 dB compression point	min. +5 dBm	
Power supply	preamplifier	+15 V DC (max. 0.3 A)
	switching network	+12 V DC (max. 0.75 A)
Connector	SMA female	
Control connector	10-contact, round, male	
MTBF	> 100 000 h	
Operating temperature range	-30°C to +55°C	
Dimensions	$\varnothing \times H$; with radome	approx. 210 mm \times 390 mm (8 in \times 15 in)
Weight	approx. 1.7 kg (4 lb)	

Ordering information

Ordering information	Type	Order No.
Crossed log-periodic antenna	R&S®HL024S7	4042.8505.02

Recommended extras

Control unit	R&S®GB016	4056.7006.03
Control cable, length: 10 m	R&S®GB016Z1	4056.7270.02
Microwave cable, length: 5 m	R&S®AC008W2	0751.6931.04
Microwave cable, length: 10 m	R&S®AC008W2	0751.6931.05
Adapter for R&S®HZ-1	R&S®HL025Z1	4053.4006.03
Wooden tripod	R&S®HZ-1	0837.2310.02
Module for R&S®OSP, for controlling R&S®HL024Sx and R&S®HL050S7	R&S®OSP-BS016	4118.6007.03
Open switch and control platform, without touchscreen	R&S®OSP-220	1528.3105.02
Open switch and control platform, with touchscreen	R&S®OSP-230	1528.3105.03

Typical radiation patterns

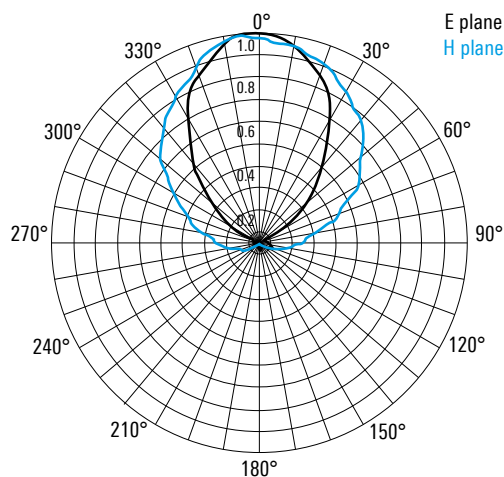

R&S®HL024S8 CROSSED LOG- PERIODIC ANTENNA

1 GHz to 18 GHz

Log-periodic directional antenna consisting of the R&S®HL024A1 and two broadband preamplifiers for horizontal and vertical polarization



The R&S®HL024S8 consists of the R&S®HL024A1 crossed log-periodic antenna and two broadband preamplifiers. It is suitable for the reception of linearly polarized waves.

Two RF connectors are provided for simultaneous use of both polarization planes.

The preamplifiers can be optionally switched on. They prevent a significant reduction in S/N due to loss in RF cables connecting the antenna to a receiver.

The antenna can also be used as a feed for the R&S®AC008 microwave directional antenna.

Key facts

- ▶ Wide frequency range
- ▶ Selectable broadband preamplifiers
- ▶ Simultaneous reception of both polarization planes
- ▶ No reduction in S/N due to the use of low-noise amplifiers at the antenna outputs
- ▶ Usable as a feed for R&S®AC008 microwave directional antenna



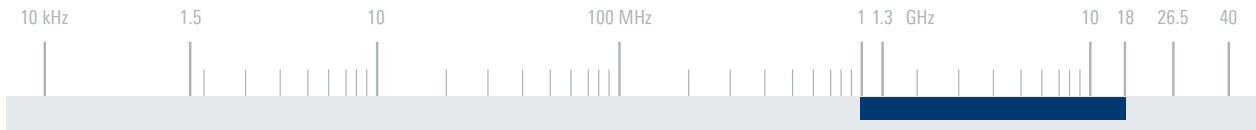

Specifications

Frequency range	1 GHz to 18 GHz	
Polarization	horizontal and vertical (simultaneously)	
Input impedance	50 Ω	
VSWR	< 3	
Antenna gain (passive)	typ. 6 dBi	
Noise figure	max. 3.6 dB	
Realized gain (active)	typ. 36 dB	
1 dB compression point	min. +5 dBm	
Power supply	preamplifier	+15 V DC (max. 0.7 A)
	switching network	+12 V DC (max. 1 A)
Connector	2 \times SMA female	
Control connector	10-contact, round, male	
MTBF	> 55 000 h	
Operating temperature range	-30°C to +55°C	
Dimensions	$\varnothing \times H$; with radome	approx. 210 mm \times 390 mm (8 in \times 15 in)
Weight	approx. 1.7 kg (4 lb)	

Ordering information

Ordering information	Type	Order No.
Crossed log-periodic antenna	R&S®HL024S8	4042.7509.02

Recommended extras

Control unit	R&S®GB016	4056.7006.03
Control cable, length: 10 m	R&S®GB016Z1	4056.7270.02
Microwave cable, length: 5 m	R&S®AC008W2	0751.6931.04
Microwave cable, length: 10 m	R&S®AC008W2	0751.6931.05
Adapter for R&S®HZ-1	R&S®HL025Z1	4053.4006.03
Wooden tripod	R&S®HZ-1	0837.2310.02
Module for R&S®OSP, for controlling R&S®HL024Sx and R&S®HL050S7	R&S®OSP-BS016	4118.6007.03
Open switch and control platform, without touchscreen	R&S®OSP-220	1528.3105.02
Open switch and control platform, with touchscreen	R&S®OSP-230	1528.3105.03

Typical radiation patterns

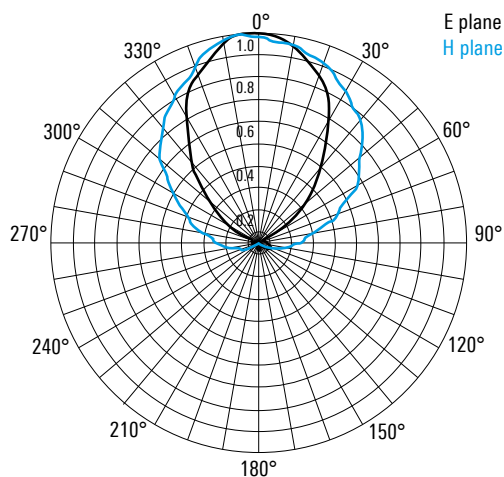

R&S®HL024S9 CROSSED LOG- PERIODIC ANTENNA

1 GHz to 18 GHz

Log-periodic directional antenna consisting of the R&S®HL024A1, two broadband preamplifiers and a switching network for linear or circular polarization



The R&S®HL024S9 consists of the R&S®HL024A1 crossed log-periodic antenna and two broadband preamplifiers. It is suitable for the reception of linearly and circularly polarized waves.

Due to the integrated switching network, horizontal, vertical, left-hand or right-hand circular polarization can be selected.

The preamplifiers prevent a significant reduction in S/N due to loss in RF cables connecting the antenna to a receiver.

The antenna can also be used as a feed for the R&S®AC008 microwave directional antenna.

Key facts

- ▶ Wide frequency range
- ▶ Broadband preamplifiers
- ▶ Switching network for horizontal, vertical and circular polarization
- ▶ No reduction in S/N due to the use of a low-noise amplifier at the antenna output
- ▶ Usable as a feed for R&S®AC008 microwave directional antenna



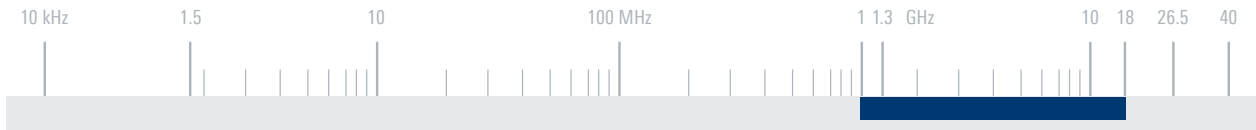

Specifications

Frequency range	1 GHz to 18 GHz	
Polarization	horizontal, vertical, left-hand or right-hand circular	
Input impedance	50 Ω	
VSWR	< 3	
Realized gain	linear	typ. 36 dB
	circular	typ. 35 dB
Noise figure	max. 3.6 dB	
1 dB compression point	min. +5 dBm	
Power supply	preamplifier	+15 V DC (max. 0.5 A)
	switching network	+12 V DC (max. 1 A)
Connector	SMA female	
Control connector	10-contact, round, male	
MTBF	> 55 000 h	
Operating temperature range	-30°C to +55°C	
Dimensions	$\varnothing \times H$; with radome	approx. 210 mm \times 390 mm (8 in \times 15 in)
Weight	approx. 1.7 kg (4 lb)	

Ordering information

Ordering information	Type	Order No.
Crossed log-periodic antenna	R&S®HL024S9	4047.6252.02

Recommended extras

Control unit	R&S®GB016	4056.7006.03
Control cable, length: 10 m	R&S®GB016Z1	4056.7270.02
Microwave cable, length: 5 m	R&S®AC008W2	0751.6931.04
Microwave cable, length: 10 m	R&S®AC008W2	0751.6931.05
Adapter for R&S®HZ-1	R&S®HL025Z1	4053.4006.03
Wooden tripod	R&S®HZ-1	0837.2310.02
Module for R&S®OSP, for controlling R&S®HL024Sx and R&S®HL050S7	R&S®OSP-BS016	4118.6007.03
Open switch and control platform, without touchscreen	R&S®OSP-220	1528.3105.02
Open switch and control platform, with touchscreen	R&S®OSP-230	1528.3105.03

Typical radiation patterns

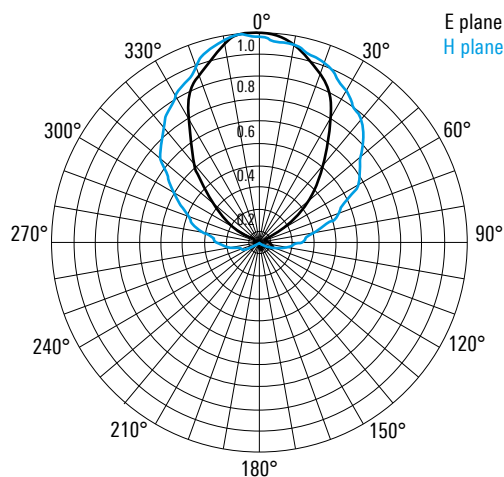

R&S®HL050 LOG-PERIODIC ANTENNA

850 MHz to 26.5 GHz

Log-periodic directional antenna for linear polarization



Its broadband characteristics make the R&S®HL050 log-periodic antenna ideal for radiomonitoring and measurements tasks.

When used as a feed in reflector antennas, the antenna offers optimum secondary radiation characteristics due to its almost rotation-symmetrical radiation pattern.

The R&S®HL050 can be used as a separate antenna or as a feed for the R&S®AC008 microwave directional antenna.

Key facts

- ▶ Extremely wide frequency range
- ▶ Rotation-symmetrical radiation patterns
- ▶ High gain due to V-shaped configuration of antenna elements
- ▶ Usable as a feed for R&S®AC008 microwave directional antenna
- ▶ Individual calibrations in line with ANSI C63.5 and CISPR 16-1-6
- ▶ Accredited calibration available on request



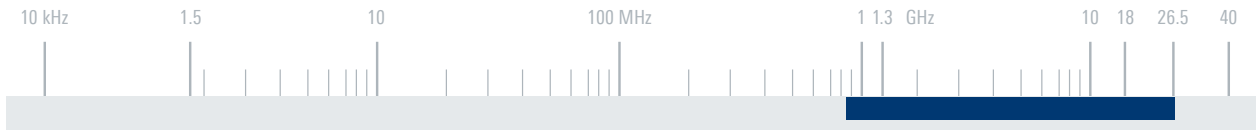

Specifications

Frequency range	850 MHz to 26.5 GHz	
Polarization	linear	
Input impedance	50 Ω	
VSWR	≤ 2.5	
Max. input power	10 W to 2 W	
Gain	typ. 8.5 dBi	
Connector	PC 3.5 female	
MTBF	> 100000 h	
Operating temperature range	-30°C to +55°C	
Protection class	IPx5	
Max. wind speed	without ice deposit	180 km/h
Dimensions	∅ × H; with radome	approx. 210 mm × 300 mm (8 in × 12 in)
Weight	approx. 0.7 kg (2 lb)	

Ordering information

Ordering information	Type	Order No.
Log-periodic antenna	R&S®HL050	4062.4063.02
Standard calibration (free-space antenna factors)	R&S®HL050-CAL	4062.4257.02

Recommended extras

Microwave cable, length: 5 m	R&S®AC008W2	0751.6931.04
Microwave cable, length: 10 m	R&S®AC008W2	0751.6931.05
Adapter for R&S®HZ-1	R&S®HL025Z1	4053.4006.03
Wooden tripod	R&S®HZ-1	0837.2310.02

Typical gain

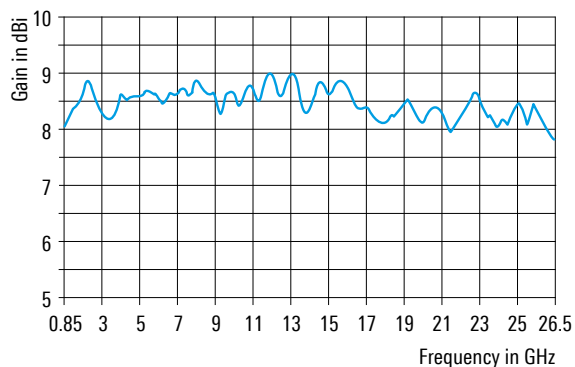

Typical radiation patterns

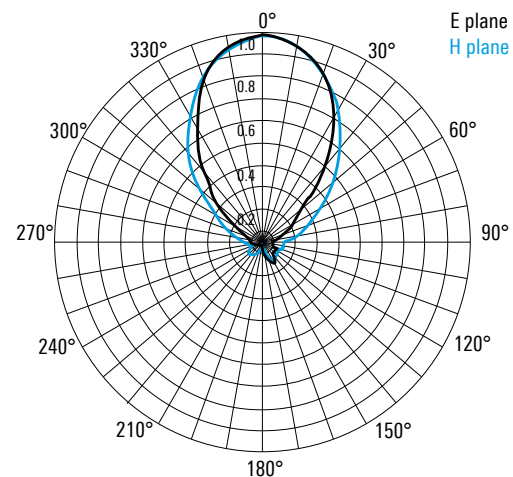

R&S®HL050S7 LOG-PERIODIC DIRECTIONAL ANTENNA WITH PREAMPLIFIER

850 MHz to 26.5 GHz

Log-periodic directional antenna consisting of the R&S®HL050 and a broadband preamplifier for linear polarization



The R&S®HL050S7 log-periodic directional antenna consists of the R&S®HL050 log-periodic antenna with preamplifier and is suitable for the reception of linearly polarized waves.

The extremely broadband and low-noise integrated preamplifier prevents a significant reduction in S/N due to loss in RF cables connecting the antenna to a receiver.

Due to its almost rotation-symmetrical radiation pattern, the R&S®HL050S7 offers optimum secondary radiation characteristics for use as a feed in reflector antennas. It is ideal as a feed for the R&S®AC008 microwave directional antennas.

Key facts

- ▶ Extremely wide frequency range
- ▶ Rotation-symmetrical radiation patterns
- ▶ Stable radiation patterns/optimum EUT illumination
- ▶ High gain due to V-shaped configuration of antenna elements
- ▶ No reduction in S/N due to the use of a low-noise amplifier at the antenna output
- ▶ Usable as a feed for R&S®AC008 microwave directional antenna
- ▶ Preamplifier can be bypassed via control unit, e.g. at high field strengths



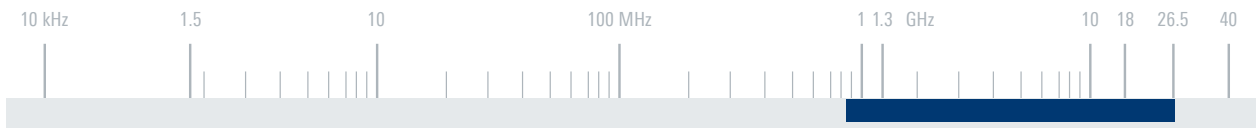

Specifications

Frequency range		850 MHz to 26.5 GHz
Polarization		linear
Input impedance		50 Ω
VSWR (with preamplifier)		< 3
Passive antenna gain		typ. 7.5 dBi
Realized gain (active)		typ. 37.5 dB
Noise figure		max. 3.6 dB
1 dB compression point (at output)		min. > 5 dBm
Power supply	amplifier	15 V/0.2 A (max.)
	switching relay	12 V/0.75 A (max.)
Connector		PC 3.5 female
Control connector		10 pin female
MTBF		> 100 000 h
Operating temperature range		-30°C to +55°C
Max. wind speed		180 km/h
Dimensions	Ø × H	approx. 210 mm × 390 mm (8 in × 15 in)
Weight		approx. 1.7 kg (4 lb)

Ordering information

Ordering information	Type	Order No.
Log-periodic directional antenna with preamplifier	R&S®HL050S7	4064.6040.02

Recommended extras

Control unit	R&S®GB016	4056.7006.03
Control cable, length: 10 m	R&S®GB016Z1	4056.7270.02
Microwave cable, length: 5 m	R&S®AC008W2	0751.6931.04
Microwave cable, length: 10 m	R&S®AC008W2	0751.6931.05
Adapter for R&S®HZ-1	R&S®HL025Z1	4053.4006.03
Wooden tripod	R&S®HZ-1	0837.2310.02
Module for R&S®OSP, for controlling R&S®HL024Sx and R&S®HL050S7	R&S®OSP-BS016	4118.6007.03
Open switch and control platform, without touchscreen	R&S®OSP-220	1528.3105.02
Open switch and control platform, with touchscreen	R&S®OSP-230	1528.3105.03

Typical radiation patterns

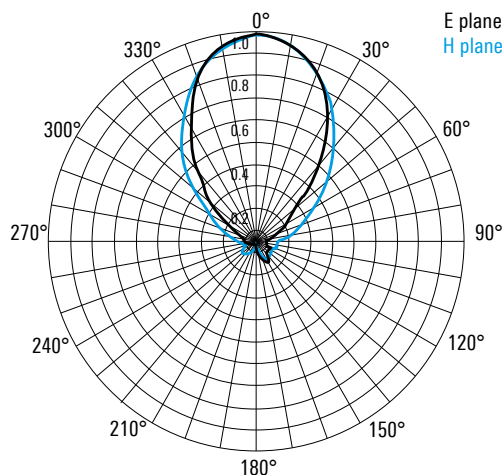

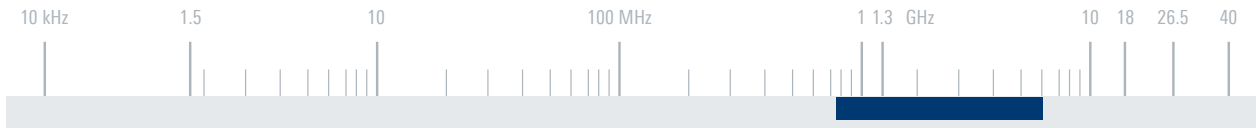

Specifications

Frequency range	750 MHz to 6 GHz	
Polarization	linear	
Nominal impedance	50 Ω	
VSWR	750 MHz to 1300 MHz	< 2.5
	above 1300 MHz	< 2
Gain	typ. 8.5 dBi	
Cross-polarization	< -20 dB	
Front-to-back-ratio	750 MHz to 1 GHz	> 15 dB
	1 GHz to 6 GHz	> 20 dB
Maximum input power	100 W CW	
RF connector	N female	
MTBF	> 100 000 h	
Operating temperature range	-30°C to +55°C	
Protection class	IP55	
Dimensions	∅ × H	approx. 0.21 m × 0.47 m (8 in × 19 in)
Weight	approx. 1.4 kg (3 lb)	

Ordering information

Ordering information	Type	Order No.
Log-periodic antenna	R&S®HL050E	4100.1003.02
Recommended extras		
Wooden tripod	R&S®HZ-1	0837.2310.02
Adapter for R&S®HZ-1	R&S®KM011Z10	4100.1703.02

Typical VSWR

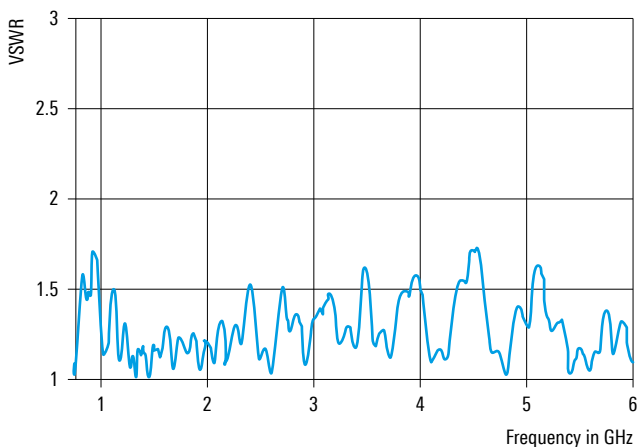

Typical antenna factor

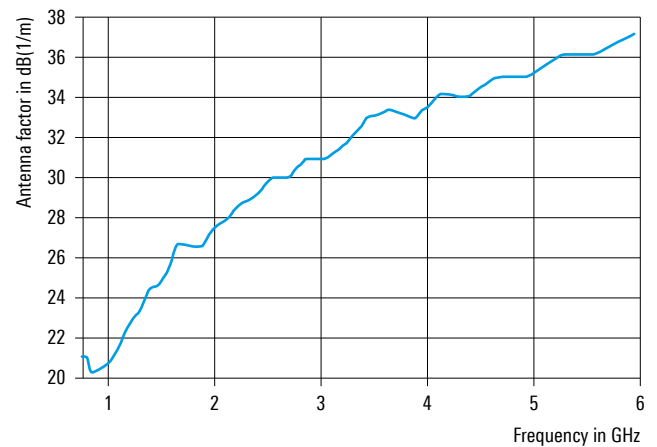

R&S®AC004R1/ R&S®AC004L1 OMNIDIRECTIONAL ANTENNAS

18 GHz to 26.5 GHz

Broadband omnidirectional antennas

Available for left-hand or right-hand circular polarization



The R&S®AC004R1 and R&S®AC004L1 omnidirectional antennas are designed for reception in the frequency range from 18 GHz to 26.5 GHz.

The circularly polarized antennas can also be used to receive horizontally and vertically polarized signals.

In addition to signal reception, the antennas are capable of radiating signals at medium power.

The mechanical design of the antennas ensures reliable operation even under harsh environmental conditions, e.g. in mobile applications.

The antennas are delivered with a weather protection cover.

Key facts

- ▶ Omnidirectional reception
- ▶ Wide frequency range
- ▶ Suitable for use under harsh environmental conditions (e.g. in mobile applications)

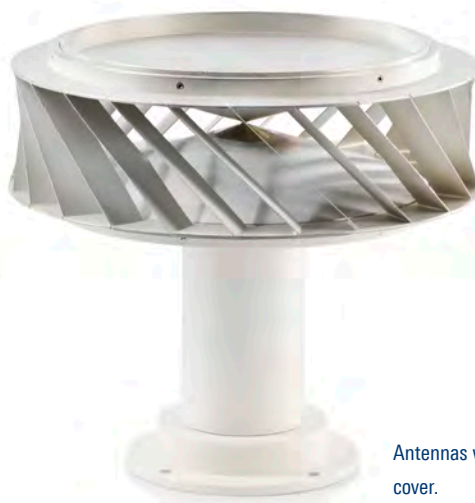

Antennas without weather protection cover.

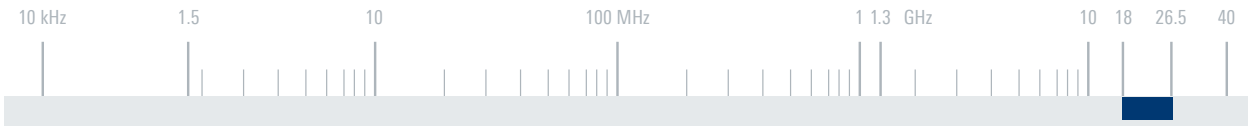

Specifications		
Frequency range		18 GHz to 26.5 GHz
Polarization		right-hand circular (R&S®AC004R1) or left-hand circular (R&S®AC004L1)
Input impedance		50 Ω
VSWR		typ. < 2.5 (see diagram)
Gain		typ. 2 dBi
Connector		RPC2.92 (K) female
Max. input power		25 W (CW, +20°C ambient temperature)
Radiation pattern, azimuth plane		omnidirectional (see diagram), uncircularity max. ±3 dB
Radiation pattern, elevation plane		directional, half-power beamwidth typ. 20°
MTBF		> 100 000 h
Operating temperature range		-35°C to +65°C
Protection class		IP54
Max. wind speed	without ice deposit	180 km/h
Dimensions	Ø × H	approx. 150 mm × 134 mm (6 in × 5 in)
Weight		approx. 1.4 kg (3 lb)

Ordering information	Type	Order No.
Omnidirectional antenna		
For right-hand circular polarization	R&S®AC004R1	0749.3000.03
For left-hand circular polarization	R&S®AC004L1	4078.4000.02

Typical VSWR

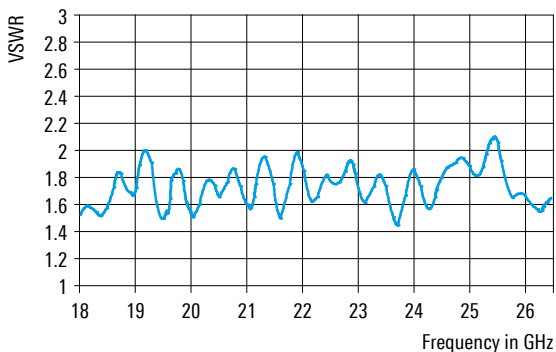

Typical horizontal radiation pattern

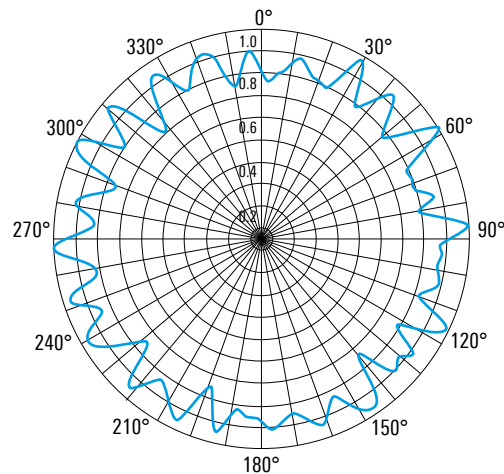

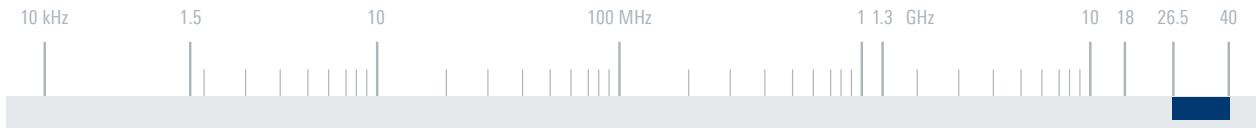

Specifications

Frequency range		26.5 GHz to 40 GHz
Polarization		right-hand circular (R&S®AC004R2) or left-hand circular (R&S®AC004L2)
Input impedance		50 Ω
VSWR		typ. ≤ 2.5 (see diagram)
Gain		typ. 2 dBi
Connector		RPC2.92 (K) female
Max. input power		25 W (CW, +25°C ambient temperature)
Radiation pattern, azimuth plane		omnidirectional (see diagram), uncircularity max. ±3 dB
Radiation pattern, elevation plane		directional, half-power beamwidth typ. 20°
MTBF		> 100 000 h
Operating temperature range		-35°C to +65°C
Protection class		IP54
Max. wind speed	without ice deposit	180 km/h
Dimensions	Ø × H	approx. 95 mm × 130 mm (4 in × 5 in)
Weight		approx. 0.9 kg (2 lb)

Ordering information

	Type	Order No.
Omnidirectional antenna		
For right-hand circular polarization	R&S®AC004R2	0749.3251.03
For left-hand circular polarization	R&S®AC004L2	4078.5006.02

Typical VSWR

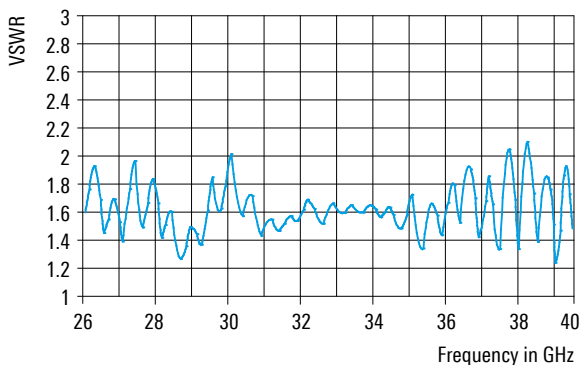

Typical horizontal radiation pattern

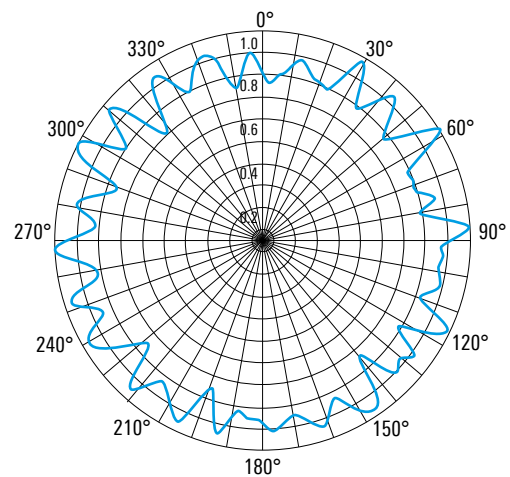

R&S®HF9070M BROADBAND OMNIDIRECTIONAL ANTENNA

800 MHz to 26.5 GHz

Broadband omnidirectional antenna for detecting and monitoring mobile radio and microwave signals

Also capable of transmitting low-power signals (e.g. for EMS measurements)



The linearly polarized R&S®HF9070M broadband omnidirectional antenna covers the extremely wide frequency range from 800 MHz to 26.5 GHz.

As a receiving antenna, its primary fields of application are detecting, monitoring and measuring GSM and microwave signals with high sensitivity. As a transmitting antenna, it is primarily designed to transmit low-power signals (e.g. to carry out EMS measurements or to emit test signals).

By using a low-attenuation, weatherproof radome, reliable operation of the antenna is ensured even in harsh environments.

The RF connector is a PC 3.5 female that is mechanically compatible with SMA and K connectors.

Key facts

- ▶ Extremely wide frequency range
- ▶ Compact dimensions
- ▶ High efficiency
- ▶ Robust design – ideal for use on board vehicles



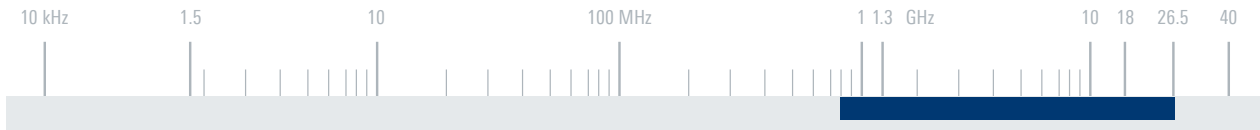

Specifications

Frequency range		800 MHz to 26.5 GHz
Polarization		linear/vertical
Input impedance		50 Ω
VSWR	f ≤ 1 GHz f > 1 GHz	≤ 2.5 < 2.0
Max. input power		50 W to 10 W CW up to +40°C ambient temperature
Gain		1 dBi to 5 dBi (typ.)
Uncircularity of azimuth pattern	at f < 20 GHz at f > 20 GHz	±1 dB ±1.5 dB
Connector		PC 3.5 female
Operating temperature range		-30°C to +50°C
Protection class		IPx5
MTBF		> 100 000 h
Max. wind speed	without ice deposit with 30 mm radial ice deposit	275 km/h 200 km/h
Dimensions	Ø × H	approx. 210 mm × 265 mm (8 in × 10 in)
Weight		approx. 1.5 kg (3 lb)

Ordering information

Ordering information	Type	Order No.
Broadband omnidirectional antenna, color: silver grey (RAL 7001)	R&S®HF9070M	4070.3279.02
Broadband omnidirectional antenna, color: squirrel grey (RAL 7000)	R&S®HF9070M	4070.3279.03
Broadband omnidirectional antenna, color: bronze green (RAL 6031)	R&S®HF9070M	4070.3279.04

Recommended extras

Mast and tripod adapter	R&S®KM011Z8	4090.4006.02
Mast, length: 6 m	R&S®KM011	0273.9116.02
Wooden tripod	R&S®HZ-1	0837.2310.02

Typical azimuth and elevation diagrams at 15 GHz

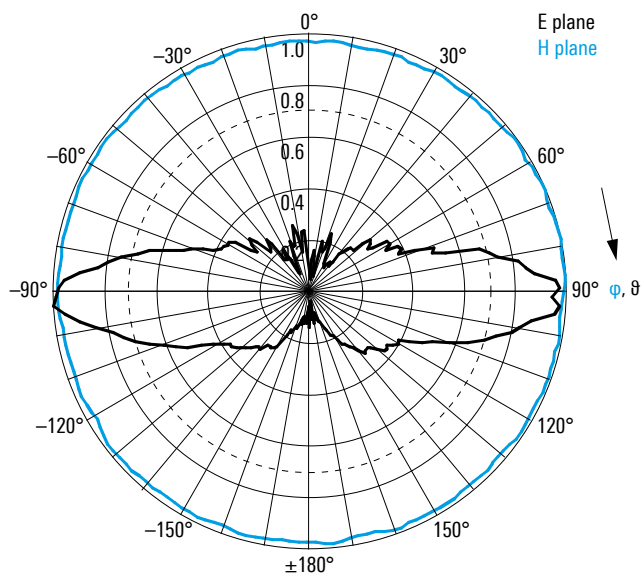

Typical VSWR

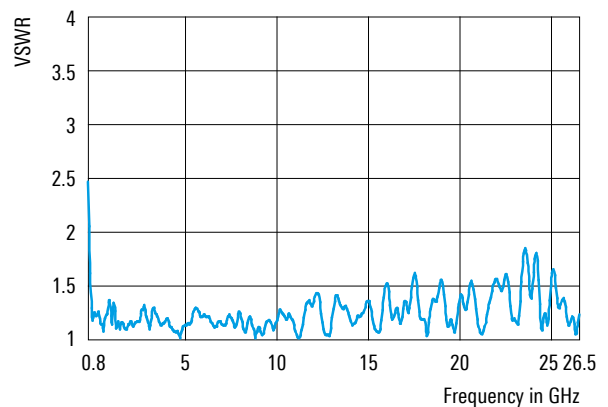

R&S®AD016MC COMPACT BROADBAND TX ANTENNA

800 MHz to 8 GHz

For transmission and reception



The linearly polarized R&S®AD016MC compact broadband TX antenna covers the wide frequency range from 800 MHz to 8 GHz for transmit and receive purposes.

Due to its mechanical design as well as its weather protection, the antenna is suited for use in exposed positions and under tough environmental conditions, e.g. on board ships.

Key facts

- ▶ For naval applications
- ▶ Ideally suited for aeronautical radiocommunications (e.g. LINK 16: 960 MHz to 1215 MHz)
- ▶ Very low cross-polarization
- ▶ Small size, compact design
- ▶ High efficiency



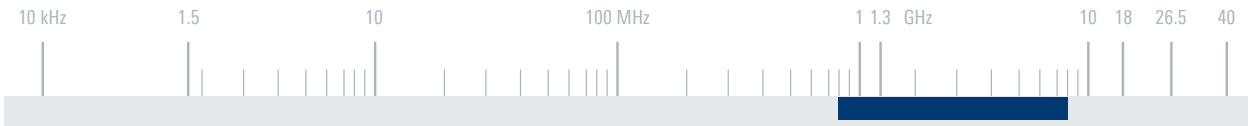

Specifications		
Frequency range		800 MHz to 8 GHz
Polarization		linear, vertical
Nominal impedance		50 Ω
VSWR	0.8 GHz to 0.95 GHz	< 3.0
	> 0.95 GHz	< 2.0
Gain		typ. 2 dBi
Polarization decoupling		> 20 dB
Radiation patterns		horizontal: omnidirectional
Maximum input power	for frequencies ≤ 4 GHz	200 W CW
	for frequencies > 4 GHz	100 W CW
RF connector		N female
MTBF		> 100 000 h
Operating temperature range		-30°C to +70°C
Protection class		IP65
Max. wind speed	without ice deposit	275 km/h
Dimensions	∅ × H	approx. 0.21 m × 0.275 m (8 in × 11 in)
Weight		approx. 2.5 kg (6 lb)

Ordering information	Type	Order No.
Compact broadband TX antenna	R&S®AD016MC	4091.6002.02

Typical VSWR

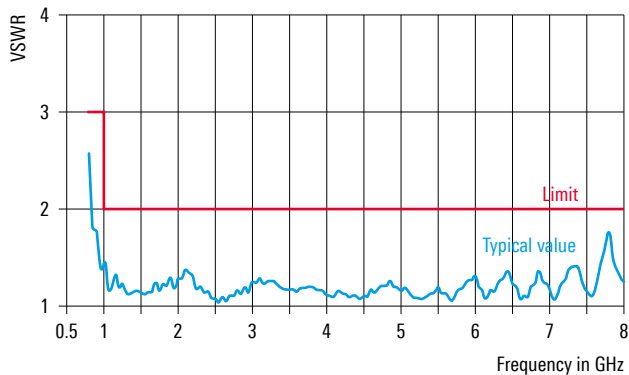

Typical vertical radiation pattern at 1.1 GHz

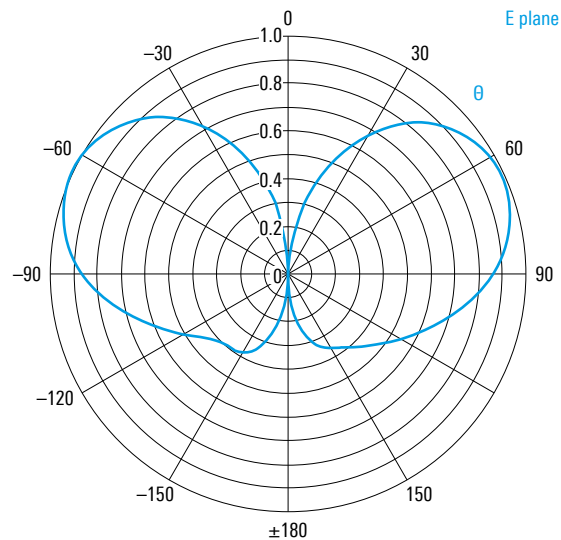

R&S®HF907 DOUBLE-RIDGED WAVEGUIDE HORN ANTENNA

800 MHz to 18 GHz

Broadband directional antenna, ideal for
EMC measurements



The linearly polarized R&S®HF907 double-ridged waveguide horn antenna is a broadband, compact transmitting and receiving antenna for the frequency range from 800 MHz to 18 GHz.

High gain and low VSWR permit the measurement of weak signals and the generation of high field strengths without any significant return loss.

The R&S®HF907 sets itself apart from conventional broadband horn antennas in that its radiation pattern contains only a single main lobe over the entire frequency range; there are no appreciable side lobes.

The antenna is made of aluminum to keep its weight low.

Key facts

- ▶ Wide frequency range
- ▶ High and constant gain
- ▶ Low VSWR
- ▶ Radiation pattern contains only one main lobe over the entire frequency range
- ▶ Input power up to 300 W CW/500 W PEP
- ▶ Ideal for use in EMC laboratories
- ▶ Compact size
- ▶ Individual calibrations in line with ANSIC63.5, CISPR 16-1-6 and SAE ARP958
- ▶ Accredited calibration available on request

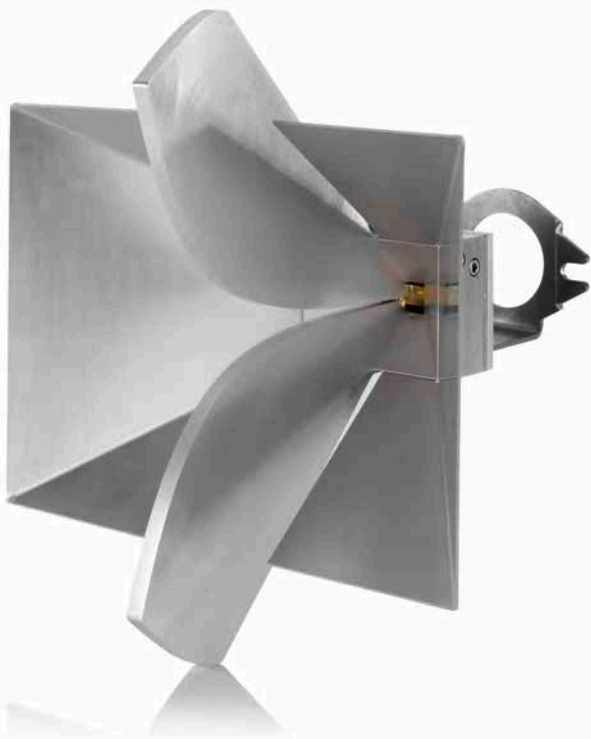

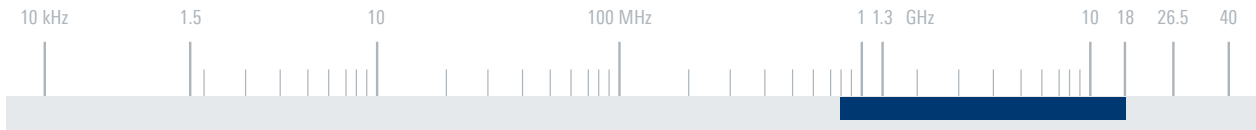

Specifications

Frequency range		800 MHz to 18 GHz
Polarization		linear
Cross-polarization		< -25 dB; typ. < -30 dB
Nominal impedance		50 Ω
VSWR	f < 1.5 GHz	< 3.0
	f ≥ 1.5 GHz	< 2.0
Max. input power (+40°C ambient temperature)	0.8 to 4.5 GHz	300 W CW
	at 10 GHz	200 W CW
	at 18 GHz	150 W CW
Gain		5 dBi to 14 dBi (typ.)
Connector		N female
Operating temperature range		-10°C to +50°C
MTBF		> 100 000 h
Dimensions	W × H × L	approx. 305 mm × 226 mm × 280 mm (12 in × 9 in × 11 in)
Weight		approx. 1.9 kg (4 lb)

Ordering information

Ordering information	Type	Order No.
Double-ridged waveguide horn antenna	R&S®HF907	4070.7000.02

Recommended extra

Wooden tripod	R&S®HZ-1	0837.2310.02
---------------	----------	--------------

Typical gain

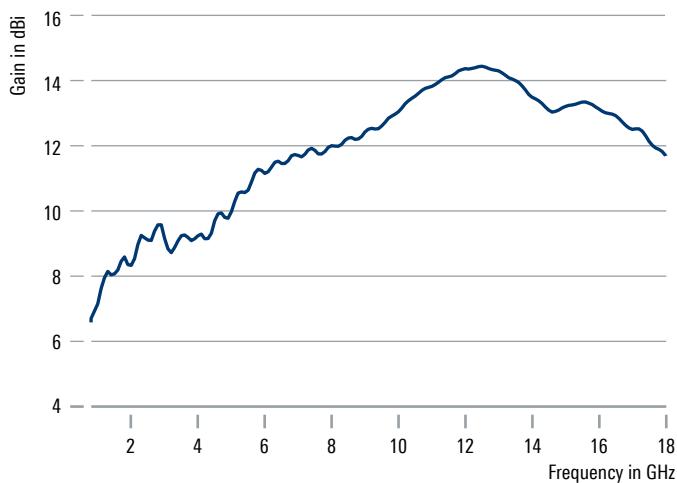

Typical VSWR

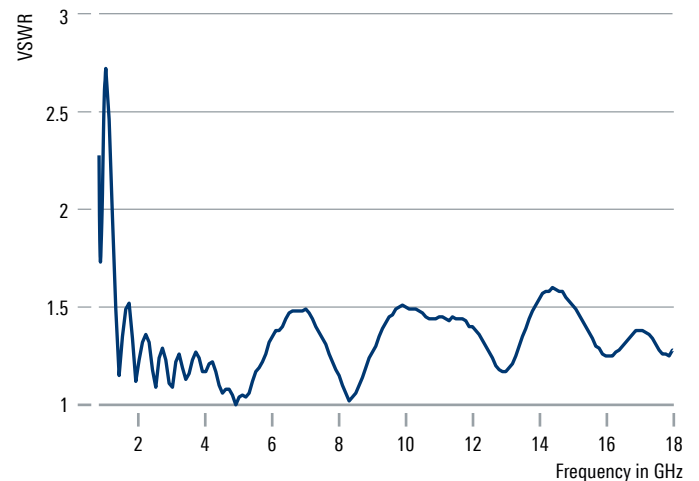

R&S®HF918 HIGH-GAIN SHF ANTENNA

800 MHz to 18 GHz

For broadband transmission and reception



The R&S®HF918 high-gain SHF antenna provides broadband transmission and reception in the frequency range from 800 MHz to 18 GHz.

Thanks to its outstanding power rating and matching (VSWR), it can also be used in transmission applications.

The sturdy design as well as the low weight of this antenna ensure easy handling and make it ideal for use in monitoring applications under severe outdoor conditions.

The high gain up to 18 GHz allows the reception and analysis of weak signals.

Key facts

- ▶ Wide frequency range
- ▶ High gain, optimum beamwidth for good emitter locating
- ▶ Stable radiation patterns over entire frequency range
- ▶ Very low cross-polarization
- ▶ Compact size, low weight
- ▶ Outstanding power ratings up to 18 GHz



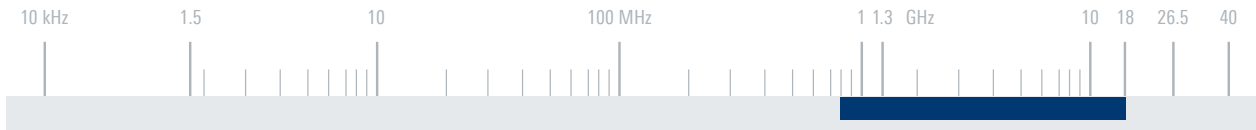

Specifications

Frequency range		800 MHz to 18 GHz
Polarization		linear
Nominal impedance		50 Ω
VSWR		typ. < 2 (see diagram)
Gain		see diagram
Cross-polarization		< -25 dB; typ. -30 dB
Max. input power (at sea level, +40°C ambient temperature)	800 MHz	300 W CW
	5 GHz	190 W CW
	10 GHz	130 W CW
	18 GHz	100 W CW
RF connector		N female
MTBF		> 100 000 h
Protection class		IP55, in line with EN 60529
Operating temperature range		-30°C to +55°C
Max. wind speed	without ice deposit	275 km/h
Dimensions	Ø × L	approx. 0.41 m × 0.3 m (16 in × 12 in)
Weight		approx. 5.5 kg (12 lb)

Ordering information

Ordering information	Type	Order No.
High-gain SHF antenna, color: silver gray (RAL 7001)	R&S®HF918	4201.1008.02
Recommended extras		
Wooden tripod	R&S®HZ-1	0837.2310.02
Adapter for R&S®HZ-1	R&S®HL025Z1	4053.4006.03

Typical gain

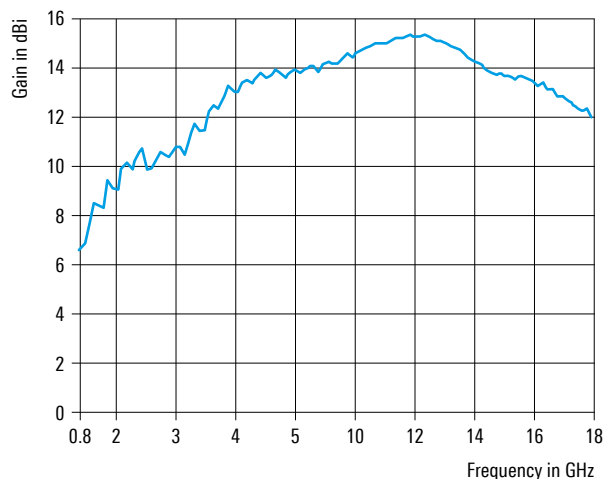

Typical VSWR and limit line

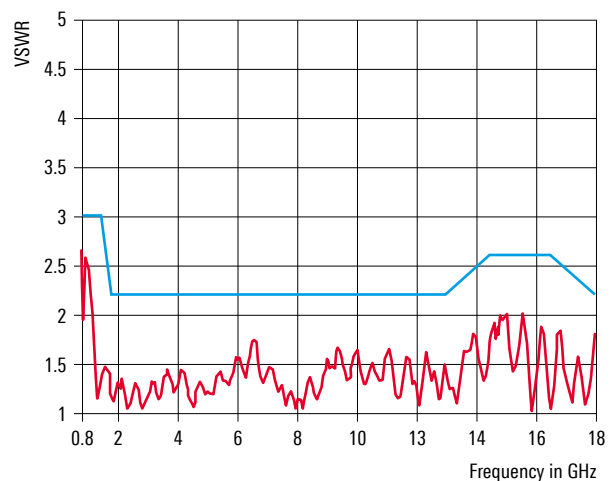

CHAPTER 4

ACCESSORIES

Type	Designation	Page
R&S®GX002 New	Junction unit	176
R&S®IN600	Bias unit	178
R&S®FT224	VHF/UHF diplexer	180
R&S®GB016	Control unit	182
R&S®OSP-BS016 New	Antenna control module	184
R&S®RD016	Antenna rotator	186
R&S®GB130	Control unit	188
R&S®RD130	Antenna rotator	190
R&S®CP001	Antenna remote control software (ARCOS)	192
R&S®OCB600	Outdoor control for R&S®AU600	194
R&S®FU129	Antenna filter unit	196
R&S®MSD	Modular system device	198

R&S®GX002 JUNCTION UNIT

1.5 MHz to 30 MHz

For supply and control of ATU based products

New



The R&S®GX002 junction unit forms the junction between an HF transceiver system (Rohde & Schwarz or third-party system) and the R&S®Series002 antenna tuning units (ATU). This includes:

- ▶ R&S®HX002H0 HF dipole with ATU (1 kW)
- ▶ R&S®HX002H3/H3M HF dipole with ATU (150 W)
- ▶ R&S®FK002H0 antenna tuning unit (1 kW)

For controlling, the R&S®GX002 offers a LAN interface, R&S®RCB optical interface and R&S®RCB serial interfaces.

Key facts

- ▶ Transceiver-independent control interface
- ▶ Works best with Rohde & Schwarz transceivers but also provides standard interfaces for integration with third-party radio systems
- ▶ Power supplied by AC or ground-isolated DC
- ▶ RF-cable-only interface to connected ATU
- ▶ Diagnostic system, status by LED or remote query



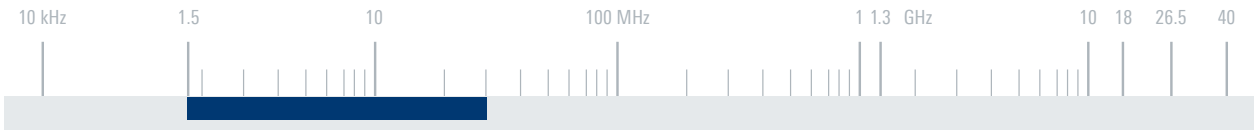

Specifications		
Frequency range		1.5 MHz to 30 MHz
Max. permissible RF input power		1 kW CW
Input impedance		50 Ω
Insertion loss		< 0.2 dB; typ. < 0.1 dB
Power supply	AC	90 V to 305 V (47 Hz to 63 Hz)
	DC	16 V to 32 V
Operating temperature range		-20°C to +55°C
Protection class	front panel	IP32
	rest of device	IP20
Dimensions		19" rackmount, 1 HU; depth approx. 450 mm (17.7 in)
Weight		approx. 7 kg (15.4 lb)

Ordering information	Type	Order No.
Junction unit	R&S®GX002	4106.0009.02
Recommended extras		
HF dipole with ATU	R&S®HX002H0	4102.7009.02
HF dipole with ATU	R&S®HX002H3	4015.6003.02
HF dipole with ATU	R&S®HX002H3M	4015.6003.12
Antenna tuning unit (1 kW)	R&S®FK002H0	4105.8006.02

System overview (sample components)

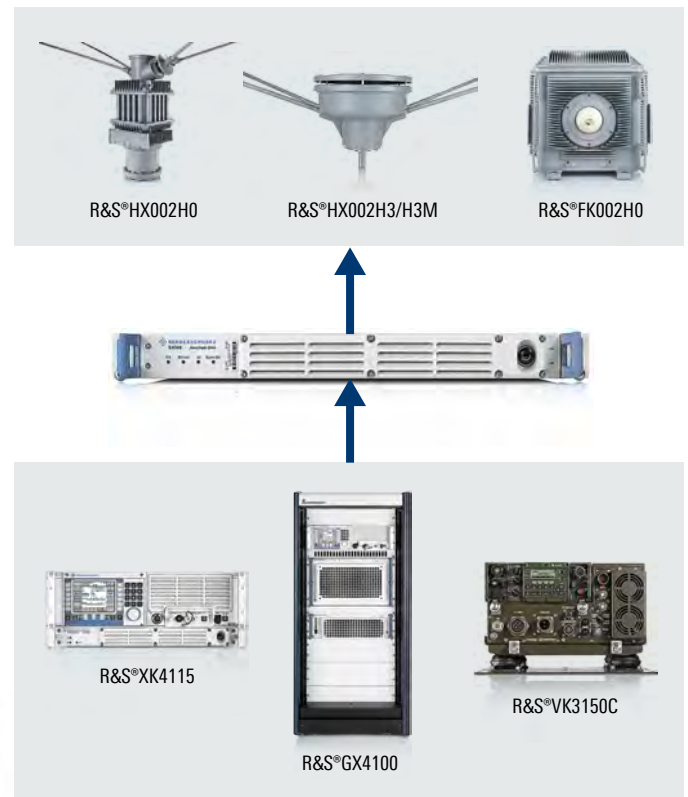

Rear view of the R&S®GX002

R&S®IN600 BIAS UNIT

8.3 kHz to 8 GHz

Power supply for up to two active receiving
antennas via signal cable



The R&S®IN600 bias unit is used to supply power to active receiving antennas.

A broadband bias tee is used to feed the antenna supply voltage to the inner conductor of the coaxial cable. The bias tee minimizes insertion loss and prevents both noise and unwanted signals from the power supply from interfering with the RF signals.

AC models are designed for stationary use where mains supply is available. DC models can be battery-supplied and used in vehicles.

The R&S®IN600 is recommended for use with Rohde&Schwarz active receiving antennas.

Model .13 is available for supplying power to the R&S®HFH2-Z2E and R&S®HFH2-Z6E measurement antennas.

Key facts

- ▶ Extremely wide frequency range
- ▶ Short-circuit-proof (optical short circuit warning indication)
- ▶ DC and AC models, both featuring a very wide input voltage range
- ▶ Rack mounting or desktop use
- ▶ Suitable for vehicle installation



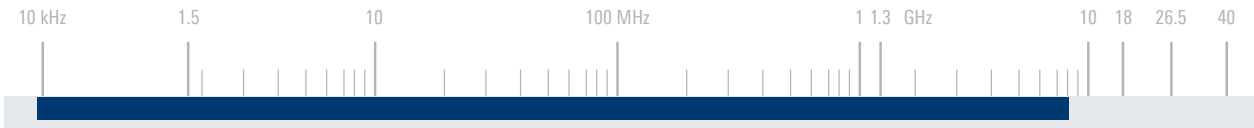

Specifications		
Frequency range	<ul style="list-style-type: none"> models .11/.12/.21/.22 model .13 	8.3 kHz to 8 GHz 8.3 kHz to 30 MHz
RF connector		N female, 50 Ω
RF insertion loss	<ul style="list-style-type: none"> models .11/.12/.21/.22 model .13 	< 2.5 dB; typ. 1.5 dB (> 20 kHz to 8 GHz) < 0.5 dB; typ. 0.25 dB
VSWR	<ul style="list-style-type: none"> models .11/.12/.21/.22 model .13 	< 3; typ. < 2 (20 kHz to 8 GHz) < 1.4; typ. 1.2
Max. RF power at antenna port		+20 dBm
Interference level at receiver port	<ul style="list-style-type: none"> models .11/.12/.21/.22 model .13 	typ. < -110 dBm (8.3 kHz to 10 MHz) typ. < -120 dBm (> 10 MHz to 8 GHz) -105 dBm to -130 dBm (meas.) (8.3 kHz to 1 MHz) < -130 dBm (meas.) (> 1 MHz to 30 MHz)
Power supply	output voltage	24 V DC ±1 V/-2 V
	max. current (each antenna port)	500 mA
	AC supply voltage range (models .11, .12 and .13 only)	100 V to 240 V AC, 50 Hz to 60 Hz/400 Hz
	DC supply voltage range (models .21 and .22 only)	10 V to 32 V DC
Operating temperature range		0°C to +50°C
Storage temperature range		-40°C to +70°C
MTBF		> 75 000 h
Dimensions	W × H × L	approx. 250 × 55 × 400 mm (10 × 2 × 16 in), (½ 19", 1 HU)
Weight		approx. 3 kg (7 lb)

Ordering information	Type	Order No.
Bias unit, AC operated, 8.3 kHz to 8 GHz, one antenna port	R&S®IN600	4094.3004.11
Bias unit, AC operated, 8.3 kHz to 8 GHz, two antenna ports	R&S®IN600	4094.3004.12
Bias unit, DC operated, 8.3 kHz to 8 GHz, one antenna port	R&S®IN600	4094.3004.21
Bias unit, DC operated, 8.3 kHz to 8 GHz, two antenna ports	R&S®IN600	4094.3004.22
Bias unit, AC operated, 8.3 kHz to 30 MHz, for R&S®HFH2-Z2E/HFH2-Z6E, one antenna port	R&S®IN600	4094.3004.13
Recommended extras		
19" rack adapter, for mounting two ½ 19" instruments	R&S®ZZA-KN20	1175.3191.00
19" rack adapter, for mounting one ½ 19" instrument	R&S®ZZA-KN21	1175.3204.00

Block diagram

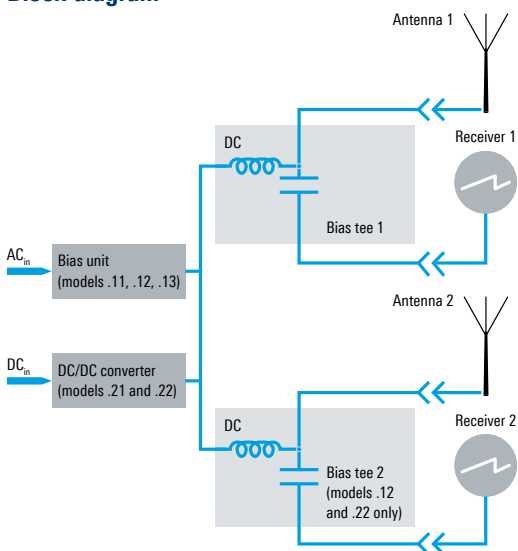

Rear view of R&S®IN600, model .22

R&S®FT224 VHF/UHF DIPLEXER

100 MHz to 174 MHz

225 MHz to 450 MHz

For connecting a broadband antenna to transceivers with separate VHF and UHF outputs



The R&S®FT224 VHF/UHF diplexer allows the connection of a broadband antenna (e.g. the R&S®HK014E VHF/UHF coaxial dipole) to transceivers with separate VHF and UHF outputs or to separate VHF and UHF transceivers.

The diplexer has a maximum input power of 200 W CW and 800 W PEP. These values (for one channel) also apply for simultaneous operation of both channels.

Key facts

- ▶ Low passband attenuation
- ▶ High stopband attenuation
- ▶ 200 W CW/800 W PEP
- ▶ Compact design
- ▶ Versatile applications



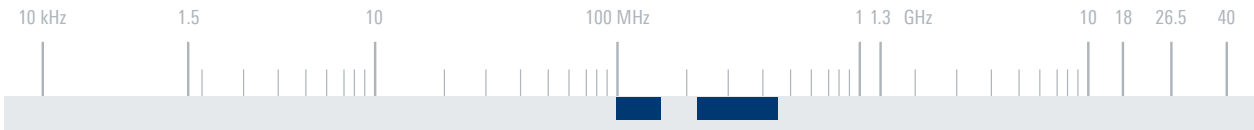

Specifications		
Frequency range		100 MHz to 174 MHz, 225 MHz to 450 MHz
Input impedance		50 Ω
VSWR		≤ 1.5 (with 50 Ω termination)
Insertion loss	in passband	≤ 0.5 dB; typ. 0.25 dB (VHF/UHF)
	in stopband	> 30 dB (VHF/UHF)
Max. input power		200 W CW, 800 W PEP (per channel with simultaneous operation)
Connectors		3 × N female
MTBF		> 100000 h
Operating temperature range		-20°C to +55°C
Dimensions	W × H × L	approx. 130 mm × 50 mm × 130 mm (5 in × 2 in × 5 in)
Weight		approx. 0.5 kg (1 lb)

Ordering information	Type	Order No.
VHF/UHF diplexer, color: squirrel grey (RAL7000)	R&S®FT224	0525.5117.04
VHF/UHF diplexer, color: squirrel grey (RAL7000), with conformal coating	R&S®FT224	0525.5117.05
Recommended extras		
VHF/UHF coaxial dipole	R&S®HK014E	4095.5000.02
VHF/UHF coaxial dipole	R&S®HK033	4062.8369.02

Typical filter characteristic

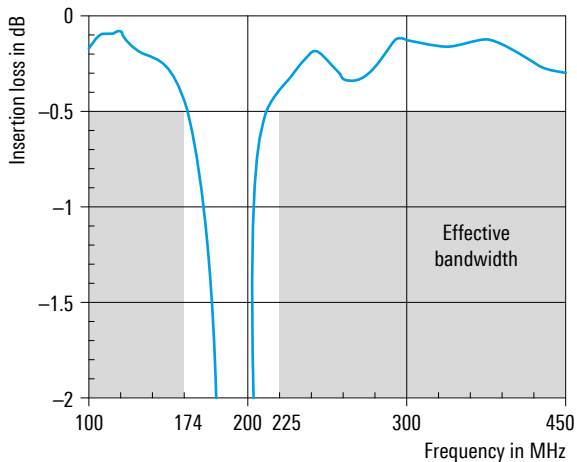

Application example for R&S®FT224

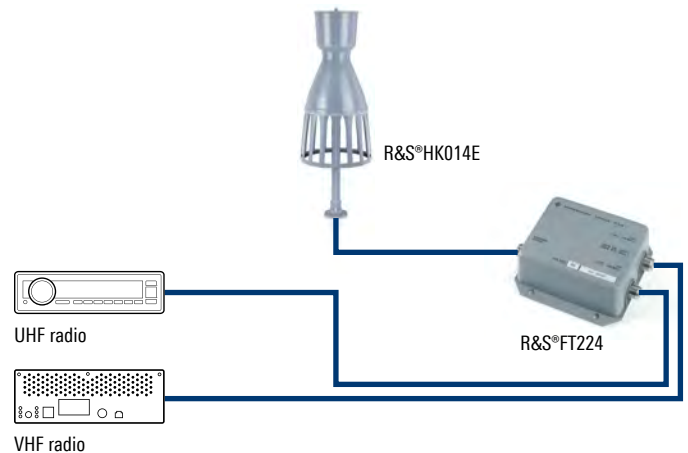

R&S®GB016 CONTROL UNIT

Selection of polarization, activating or bypassing amplifiers and power supplies of rotators and selected log-periodic antennas



The R&S®GB016 control unit is used for selecting polarization and for activating or bypassing the amplifiers and power supplies of the following log-periodic antennas:

- ▶ R&S®HL024S2, R&S®HL024S7
- ▶ R&S®HL024S8, R&S®HL024S9
- ▶ R&S®HL050S7
- ▶ R&S®HL007A2 via R&S®ZS107

It also controls the R&S®AC008 microwave antenna system in combination with the R&S®RD016 rotator.

The R&S®GB016 is remote controlled by the R&S®CP001 antenna remote control software over a LAN interface.

Key facts

- ▶ Remote control
- ▶ Mobile or stationary use
- ▶ AC or DC voltage supplied
- ▶ LAN interface (10/100 Mbit/s)
- ▶ Rotator supply and control
- ▶ Low maintenance

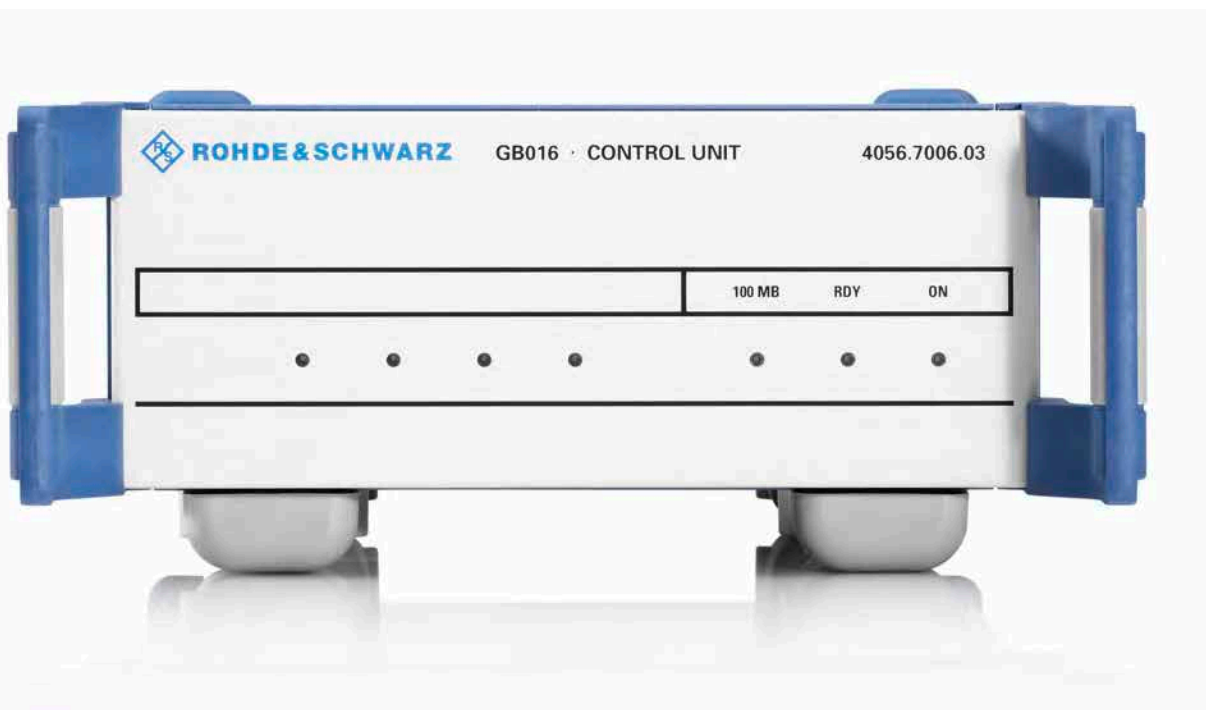

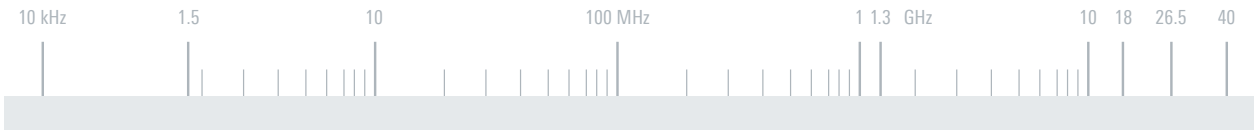

Specifications

Mains power supply	voltage	100 V to 240 V AC, 50 Hz to 60 Hz
	power consumption	< 10 A (peak)
DC power supply	voltage	21 V to 29 V DC (stabilized)
	power consumption	< 15 A (peak)
Interface for antenna control		15-contact, D-Sub female
	supply voltages	+15 V DC (max. 1.5 A), +12 V DC (max. 1.5 A)
	3 × control line	max. 0.5 A
Remote control interface		Ethernet 10/100 Mbit/s, connector RJ-45
Rotor interface		VG95328 (10 pin circular)
Rotor voltage		24 V (21 V to 29 V DC)
MTBF		> 44500 h, in line with SN29500 at +40°C ambient temperature, ground fixed
Operating temperature range		+5°C to +40°C
Dimensions	W × H × D	approx. 250 mm × 110 mm × 300 mm (10 in × 4 in × 12 in)
Weight		approx. 3 kg (7 lb)

4

Ordering information

Ordering information	Type	Order No.
Control unit	R&S®GB016	4056.7006.03
Recommended extras		
Control cable, for R&S®HL024Sx and R&S®HL050S7, length: 10 m	R&S®GB016Z1	4056.7270.02
Antenna remote control software (ARCOS)	R&S®CP001	4069.6384.0x (x = 3/5/6, depending on application)

Dimensions in mm

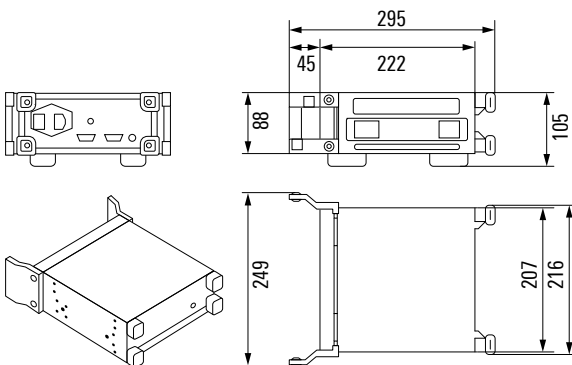

Rear view

R&S®OSP-BS016 ANTENNA CONTROL MODULE

Selection of polarization, activating or bypassing the amplifiers and power supplies of selected log-periodic antennas

New



The R&S®OSP220/R&S®OSP230 switch and control units together with the R&S®OSP-BS016 antenna control module are used to select the polarization and to activate or bypass the amplifiers and power supplies of the following log-periodic antennas:

- ▶ R&S®HL024S2, R&S®HL024S7
- ▶ R&S®HL024S8, R&S®HL024S9
- ▶ R&S®HL050S7
- ▶ R&S®HL007A2 via R&S®ZS107

Both R&S®OSP220/R&S®OSP230 models can be remote controlled via a web GUI or SCPI commands; the R&S®OSP230 additionally provides a touchscreen user interface.

Key facts

- ▶ Touchscreen for manual antenna control (R&S®OSP230)
- ▶ Web GUI for remote manual control
- ▶ Automated remote control via SCPI protocol over LAN

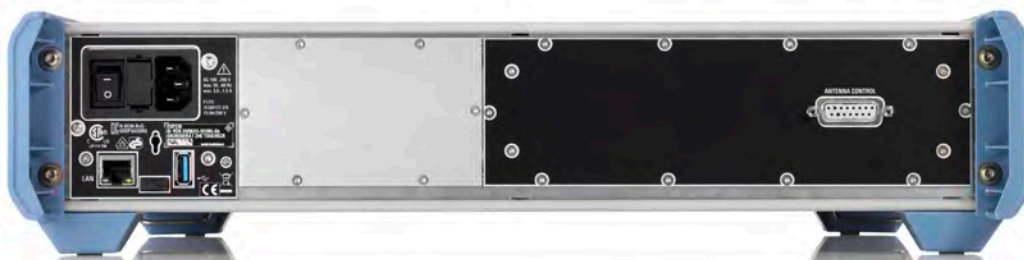

R&S®OSP220 with integrated
R&S®OSP-BS016

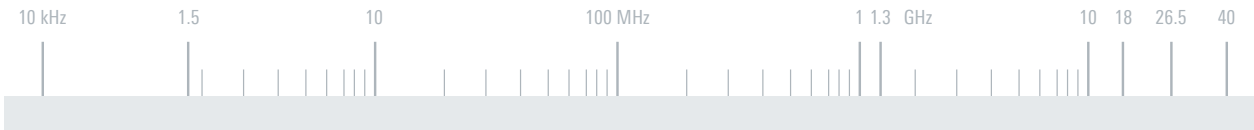

Specifications

Power supply

Rated voltage		100 V to 240 V AC (± 10%)
Rated power	with antenna	< 70 W
Interface for antenna control		15-contact, D-Sub female

Interfaces (front panel)

USB	2 × USB 2.0, type A female connector	for keyboard, mouse or USB stick
HDMI™	HDMI™, type A female connector	for external monitor, resolution 800 × 480 pixel
Touchscreen	R&S®OSP230	for manual operation, resolution 800 × 400 pixel
Status display	R&S®OSP220	display of TCP/IP address

Interfaces (rear panel)

USB	USB 3.0, type A female connector	
LAN	Ethernet RJ-45 female connector, 10/100 Mbit/s	remote control via LAN

General data

Temperature	operational temperature range	0°C to +50°C
Dimensions	W × H × D	445 mm × 108 mm × 472 mm (17.5 in × 4.3 in × 18.6 in)
Weight	with R&S®OSP-BS016 module	approx. 8 kg (17.6 lb)

Ordering information

	Type	Order No.
Switch and control unit (2 HU) with monitor interface	R&S®OSP220	1528.3105K02
Switch and control unit (2 HU) with touchscreen and monitor interface	R&S®OSP230	1528.3105K03
Antenna control module (required option for R&S®OSP220/R&S®OSP230)	R&S®OSP-BS016	4118.6007.03

Recommended extra

Control cable, for R&S®HL024Sx and R&S®HL050S7, length: 10 m	R&S®GB016Z1	4056.7270.02
--	-------------	--------------



Front view of R&S®OSP230 with touchscreen

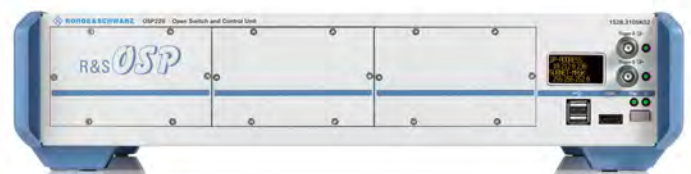

Front view of remote controlled R&S®OSP220

R&S®RD016 ANTENNA ROTATOR

Azimuth and elevation control of the R&S®AC008
microwave directional antenna



The portable R&S®RD016 antenna rotator is used to remotely rotate the R&S®AC008 microwave directional antenna for detection of RF signals and for field strength measurements.

The rotator is controlled and powered via the R&S®GB016 control unit.

Key facts

- ▶ DC gear motors ensure very short run-up time and high efficiency
- ▶ Accurate positioning
- ▶ Sturdy micro switches as limit switches for azimuth and elevation
- ▶ Protected against splash water
- ▶ Flange for fixation of the R&S®AC008 microwave directional antenna and the R&S®AC008-Z tripod



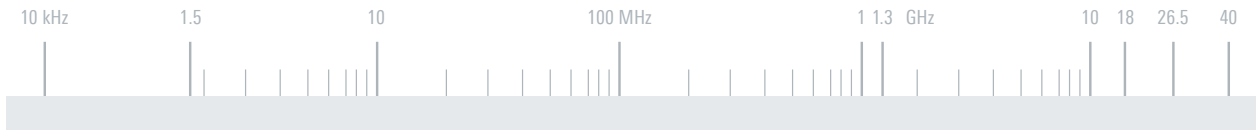

Specifications

Supply voltage range		18 V to 36 V DC
Max. rated current		10 A (peaks up to 15 A)
Motor power		240 W
Interface		RS-485
Range of movement	azimuth	360°
	elevation	0° to +30° (-6° to +74° with preadjustment of R&S®AC008)
Speed of rotation	azimuth	approx. 3°/s
	elevation	approx. 0.3°/s
Positioning accuracy		±0.1°
Permissible driving torque	azimuth	approx. 150 Nm
	elevation	approx. 80 Nm
Permissible bending moment at top flange		approx. 200 Nm
Permissible axial load		600 N
Operating temperature range		-35°C to +63°C
Max. duty cycle		25%
Protection class		IP66
Dimensions	W x H x D	approx. 360 x 310 x 270 mm (14 x 12 x 11 in)
Weight		approx. 13 kg (29 lb)

Ordering information

	Type	Order No.
Antenna rotator	R&S®RD016	4077.9008.02
Recommended extras		
Control unit	R&S®GB016	4056.7006.03
Control cable, length: 10 m	R&S®GK016K1	4077.9150.00
Antenna remote control software (ARCOS), for R&S®AC008 microwave directional antenna in combination with R&S®GB016 and R&S®RD016	R&S®CP001	4069.6384.03



R&S®RD016 with R&S®AC008 and R&S®GB016



Bottom view of R&S®RD016

R&S®GB130 CONTROL UNIT



Control of antenna rotators in azimuth and elevation

The R&S®GB130 control unit is used for positioning antenna rotators in azimuth and elevation. It is equipped with an illuminated LCD for plain text display and a numeric keypad for data entry.

Positioning and data entry can also be remote controlled over a controller interface (RS-232 or RS-485). The R&S®CP001 antenna remote control software (ARCOS) is available as an option.

The control unit can be used to control the R&S®RD130 antenna rotator (azimuth positioning only).

Key facts

- ▶ Numeric keypad for direct data entry
- ▶ LCD for plain text display
- ▶ Manual or remote control possible
- ▶ Suitable for wide AC voltage range
- ▶ No maintenance required
- ▶ No calibration required



Control section and LC display of R&S®GB130

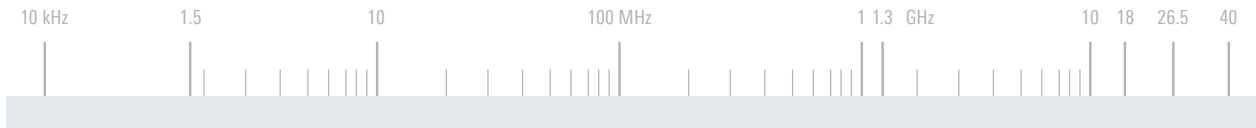

Specifications

Power supply		85 V to 264 V AC, 47 Hz to 63 Hz
Power consumption		max. 300 VA
Operating mode		manual or remote control
Controller interfaces		RS-232/RS-485
Power supply of rotator		
	voltage	24 V DC
	power	max. 100 W (azimuth), max. 80 W (elevation)
Display accuracy		0.1°
MTBF		> 10 000 h
Operating temperature range		0°C to +50°C
Dimensions	W × H × L	approx. 483 mm × 133 mm × 373 mm (19 in × 5 in × 15 in)
Weight		approx. 4.5 kg (10 lb)

Ordering information

	Type	Order No.
Control unit	R&S®GB130	4059.8755.02

Recommended extras

Antenna rotator	R&S®RD130	4059.8503.02
Cable set	R&S®GK130	
50 m		4059.8855.02
80 m		4059.8855.03
120 m		4059.8855.04
200 m		4059.8855.05
Antenna remote control software (ARCOS)	R&S®CP001	4069.6384.04

R&S®RD130 ANTENNA ROTATOR

For azimuth positioning of antennas and antenna systems



The R&S®RD130 antenna rotator is used for azimuth positioning of antennas such as the R&S®HL451 or R&S®HL471 log-periodic HF antennas.

The high-precision gear is accommodated in sand-cast aluminum housing. The housing is sealed against splashing and equipped with a pressure compensation and ventilation system. The individual parts of the transmission are permanently lubricated and therefore largely maintenance-free.

The R&S®RD130 is powered and controlled by the R&S®GB130 control unit. Remote control of the antenna rotator from a PC is also possible via the control unit and the R&S®CP001 antenna remote control software (ARCOS).

Key facts

- ▶ High-precision gear
- ▶ Very short start-up time
- ▶ High efficiency
- ▶ Permanent lubrication/virtually maintenance-free
- ▶ Compact design



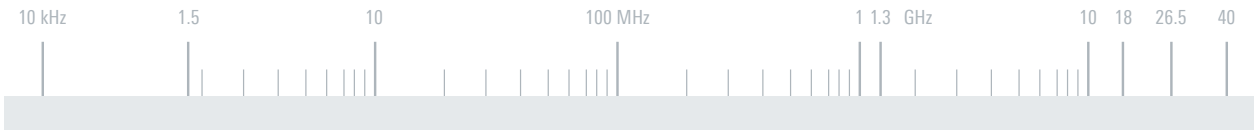

Specifications		
Voltage supply	via the R&S®GB130 control unit	24 V DC
Power consumption		2 × max. 80 W
Azimuth range		n × 360°
Speed of rotation		approx. 2°/s
Positioning accuracy		±0.1°
Permissible driving torque		approx. 1800 Nm
Starting torque		approx. 3000 Nm
Permissible bending moment at top flange		max. 6500 Nm
Permissible axial load		max. 3500 N
MTBF		> 40 000 h (at 25% on-time)
Operating temperature range		-35°C to +63°C
Max. duty cycle		25%
Protection class		IP65
Dimensions	W × H × D	approx. 550 × 405 × 417 mm (22 × 16 × 16 in)
Weight		approx. 100 kg (221 lb)

Ordering information	Type	Order No.
Antenna rotator	R&S®RD130	4059.8503.02
Recommended extras		
Control unit	R&S®GB130	4059.8755.02
Cable set, length: 50 m	R&S®GK130	4059.8855.02
Cable set, length: 80 m	R&S®GK130	4059.8855.03
Cable set, length: 120 m	R&S®GK130	4059.8855.04
Cable set, length: 200 m	R&S®GK130	4059.8855.05
Antenna remote control software (ARCOS)	R&S®CP001	4069.6384.04

Dimensions in mm

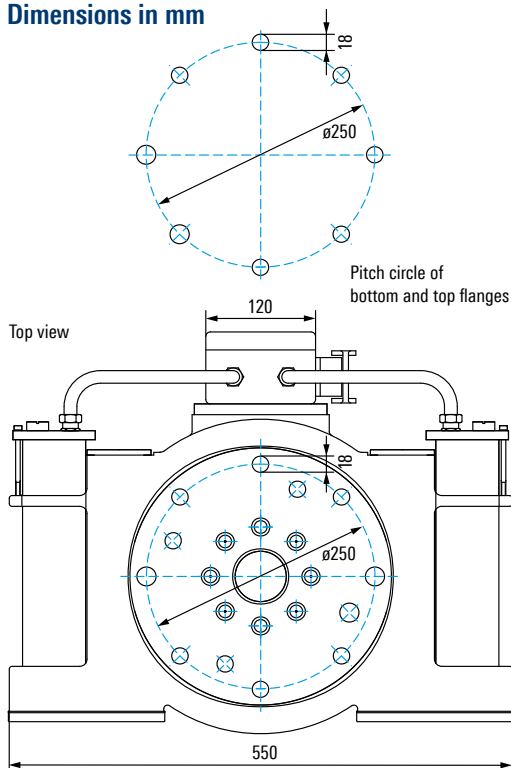

R&S®CP001 ANTENNA REMOTE CONTROL SOFTWARE (ARCOS)

All-purpose software for controlling various
Rohde & Schwarz antenna systems



The R&S®CP001 antenna remote control software (ARCOS) can be used to control the following Rohde & Schwarz antenna systems:

- ▶ R&S®AC008, including the R&S®RD016 antenna rotator, the R&S®GB016 control unit and individual feeds
- ▶ R&S®HL451 and R&S®HL471 HF antennas in combination with the R&S®RD130 antenna rotator and the R&S®GB130 control unit
- ▶ R&S®HL007A2 log-periodic antenna in combination with R&S®ZS107 polarization selector and the R&S®GB016 control unit
- ▶ R&S®HL024S2, R&S®HL024S7, R&S®HL024S8, R&S®HL024S9 and R&S®HL05S7 log-periodic antennas in combination with the R&S®GB016 control unit

The control unit of the specific antenna system is connected to the control computer (PC) via a serial or LAN interface.

The R&S®CP001 software can be used in standalone mode or in a multiworkstation network in which multiple antenna systems are controlled by several PCs.

Key facts

- ▶ Standardized operating concept for different systems
- ▶ Control routines can be integrated into customer-specific software projects
- ▶ Supports RS-232, RS-485 and LAN interfaces

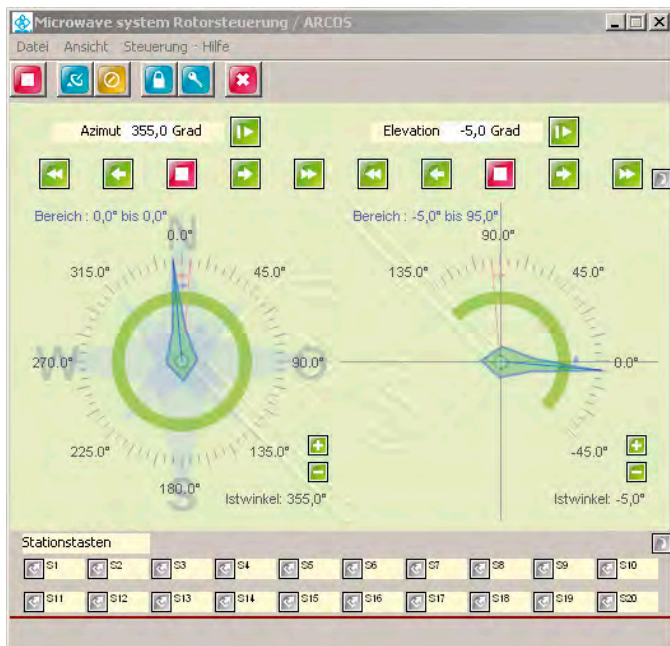

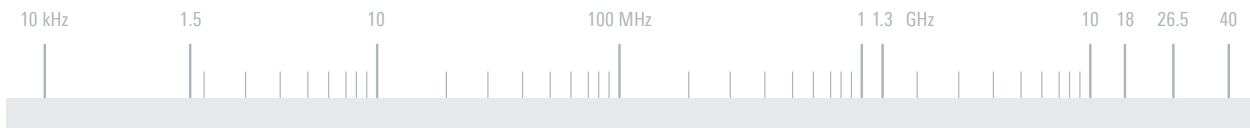

Specifications

System requirements		Windows 7 to Windows 10 operating system
Interfaces	external	RS-232, RS-485, LAN
	internal	TCP/IP
Supported Rohde&Schwarz control units		R&S®GX300, R&S®GV300, R&S®GB016, R&S®GB130

Ordering information	Type	Order No.
Antenna remote control software (ARCOS)	R&S®CP001	
For R&S®AC008 microwave directional antenna in combination with R&S®GB016 and R&S®RD016		4069.6384.03
For R&S®HL451/HL471 HF antenna systems in combination with R&S®RD130 and R&S®GB130		4069.6384.04
For R&S®HL007A2 log-periodic antenna in combination with R&S®ZS107 polarization selector		4069.6384.05
For R&S®HL024S2/HL024S7/HL024S8/HL024S9/HL050S7 microwave feeds in combination with R&S®GB016		4069.6384.06

Typical configuration: multiworkstation application with one antenna system

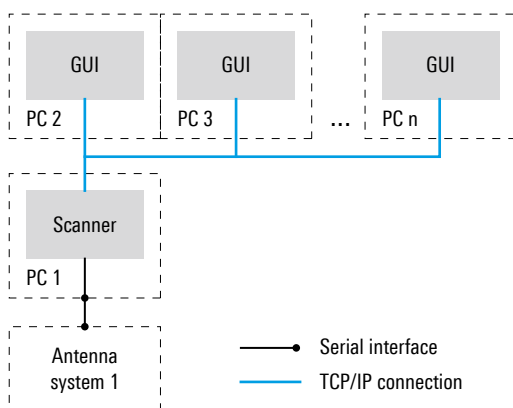

R&S®OCB600 OUTDOOR CONTROL FOR R&S®AU600

For efficient system integration of the R&S®AU600



The R&S®OCB600 is an outdoor control box for the R&S®AU600 active omnidirectional receiving antenna system. All functions of the R&S®AU600 are supported, including active/passive switching and selection of the integrated filters.

The R&S®OCB600 has two Ethernet interfaces, one DC input and one control output. The first Ethernet interface provides the link to the receiving unit (e.g. R&S®UMS300). It also features power over Ethernet (PoE) to supply power to the R&S®AU600. Alternatively, the R&S®AU600 can be powered by an external 24 V DC source via the DC input. If both power sources are connected, the DC supply has priority. The second Ethernet interface is used to connect additional devices such as the R&S®FU129 filter unit, for example. The control output connects the R&S®OCB600 to the R&S®AU600. RF cables run directly between the R&S®AU600 and the receiving unit.

The R&S®OCB600 is ideal when connecting the R&S®AU600 to the R&S®UMS300, but it can of course be used with other receivers and systems as well. For seamless integration into Rohde&Schwarz monitoring systems, a device driver for R&S®ARGUS is available.

Key facts

- ▶ Control of all functions of the R&S®AU600
- ▶ Designed for outdoor use



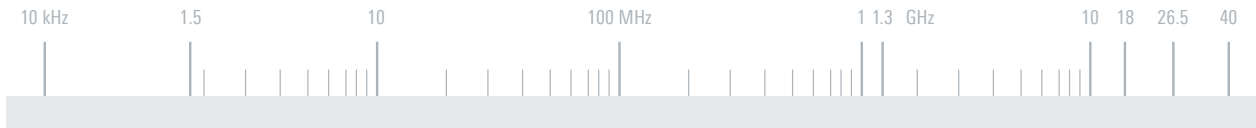

Specifications

Base unit	control input	remote control via Ethernet using SCPI
	control output	power supply and 16 differential RS-422 control signals for an R&S®AU600 antenna
Interfaces	DC voltage input	5-contact circular connector (female)
	Ethernet	10/100 Mbit Ethernet, RJ-45 (female)
	Ethernet/PoE input	10/100 Mbit Ethernet, RJ-45 (female)
Power supply	control output	55-contact MIL connector (female)
	DC in	+24 V ±2 V DC, max. 1 A
	PoE	via Ethernet connector X10 from any PoE source in line with the IEEE 802.3af or IEEE 802.3at standard
Operating temperature range	without direct sunlight	-30°C to +65°C
Storage temperature range		-30°C to +70°C
Relative humidity		95% cyclic test, +25°C/+55°C
Protection class		IPx5, in line with EN 60529
Dimensions	W × H × D	approx. 210 mm × 200 mm × 90 mm (8 in × 8 in × 4 in)
Weight		approx. 2.6 kg (6 lb)

Ordering information

Ordering information	Type	Order No.
Outdoor control for R&S®AU600	R&S®OCB600	3059.7400.02

R&S®FU129 ANTENNA FILTER UNIT

Antenna switching, rotator control and signal attenuation, amplification and filtering



The R&S®FU129 antenna filter unit is placed close to the receiving antennas. It comes with an antenna input selector for remote controlled switching of up to six antenna inputs to one output. Unwanted signals, such as those caused by nearby mobile radio base stations or strong sound and TV broadcast transmitters, can be reduced to levels suitable for the connected receiver by applying optional filters. Both strong useful signals and interfering signals can be suppressed.

All R&S®FU129 functions are controlled either directly by a control PC (connected to the R&S®FU129 via a LAN cable) or by the tried-and-tested R&S®MSD antenna control unit.

Excellent documentation for both interfaces ensures that end customers and system integrators can easily integrate the R&S®FU129 into customized systems and existing projects.

Key facts

- ▶ 1-out-of-6 antenna input selector
- ▶ Wide frequency range from DC to 26.5 GHz
- ▶ Suitable for outdoor use very close to antennas
- ▶ Integrated rotator control (azimuth and polarization/ elevation)
- ▶ Powerful options:
 - Five selectable attenuators for reducing strong signal levels
 - Two selectable amplifiers for different frequency ranges
 - Up to ten selectable filters with different characteristics
- ▶ DC power supply for active antennas



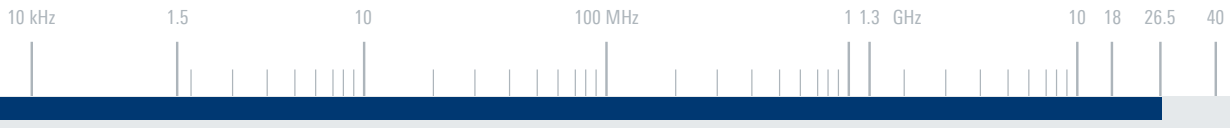

Specifications

Frequency range		DC to 26.5 GHz
Impedance		50 Ω
Insertion loss of base unit	<ul style="list-style-type: none"> ▶ models .03 and .04 (up to 3 GHz; 3 GHz to 8 GHz) ▶ model .03 (8 GHz to 12 GHz; 12 GHz to 26.5 GHz) 	<ul style="list-style-type: none"> ≤ 1.0 dB; ≤ 1.4 dB ≤ 1.7 dB; ≤ 3.0 dB
Input VSWR of base unit	<ul style="list-style-type: none"> up to 6 GHz 6 GHz to 12 GHz 12 GHz to 26.5 GHz 	<ul style="list-style-type: none"> ≤ 1.4 ≤ 1.8 ≤ 2.0
Contact switching time		≤ 15 ms
Attenuator option (DC to 26.5 GHz)	without attenuation stages 2 to 6	bypassed typ. 3/6/10/20/40 dB
Amplifier option	without amplification: DC to 26.5 GHz <ul style="list-style-type: none"> ▶ amplifier 1: 20 MHz to 8 GHz ▶ amplifier 2: 1 GHz to 26.5 GHz 	bypassed typ. +14 dB typ. +30 dB
Filter option	without filter: DC to 26.5 GHz stages 2 to 6 (11): for frequency ranges, see filter type	bypassed attenuation depends on filter
Power supply	AC DC	100 V to 240 V, 50 Hz to 60 Hz 10 V to 30 V
	power consumption, depends on options installed	25 W to 40 W/25 VA to 40 VA (typ.)
	power consumption, with both rotators in operation	100 W/100 VA (typ.)
MTBF		21 500 h
Permissible temperature range	without direct sun exposure	-40°C to +55°C
Storage temperature range		-40°C to +70°C

Ordering information	Type	Order No.
Antenna filter unit, DC to 26.5 GHz, SMA connectors	R&S®FU129	3040.3300.03
Antenna filter unit, DC to 8 GHz, N connectors	R&S®FU129	3040.3300.04
Options		
Attenuator option (max. 1)	R&S®FU129-ATT	3040.3400.02
Amplifier options		
Bypass	R&S®FU129-A0	3040.3516.02
Amplifier, 20 MHz to 8 GHz	R&S®FU129-A1	3040.3522.02
Amplifier, 1 GHz to 26.5 GHz	R&S®FU129-A2	3040.3539.02
Filter option, for up to five filters (max. 2 filter options can be installed)	R&S®FU129-FIL	3040.3600.02
Filters for filter option		
Lowpass filter, DC to 80 MHz	R&S®FU129-F1	3040.3616.02
Lowpass filter, DC to 530 MHz	R&S®FU129-F2	3040.3622.02
Lowpass filter, DC to 3000 MHz	R&S®FU129-F3	3040.3639.02
Highpass filter, 27.5 MHz to 800 MHz	R&S®FU129-F4	3040.3645.02
Highpass filter, 133 MHz to 1 GHz	R&S®FU129-F5	3040.3651.02
Highpass filter, 225 MHz to 3 GHz	R&S®FU129-F6	3040.3668.02
Highpass filter, 910 MHz to 3 GHz	R&S®FU129-F7	3040.3674.02
Highpass filter, 1.9 GHz to 2.7 GHz	R&S®FU129-F8	3040.3680.02
Highpass filter, 2.3 GHz to 5.5 GHz	R&S®FU129-F9	3040.3697.02
Highpass filter, 3.9 GHz to 9.8 GHz	R&S®FU129-F10	3040.3700.02
Highpass filter, 6 GHz to 11.5 GHz	R&S®FU129-F11	3040.3716.02
Bandpass filter, 0.8 GHz to 1.05 GHz	R&S®FU129-F12	3040.3722.02
Bandpass filter, 1.73 GHz to 2.27 GHz	R&S®FU129-F13	3040.3739.02
Bandpass filter, 2 GHz to 2.26 GHz	R&S®FU129-F14	3040.3745.02
Bandstop filter, 88 MHz to 108 MHz	R&S®FU129-F15	3040.3751.02
Other filters and options on request.		
Outdoor DC feed	R&S®FU129-H1	3059.7500.02
Outdoor control box for R&S®HL050S7	R&S®FU129-H2	3059.7600.02
Outdoor SHF preamplifier	R&S®FU129-H3	3059.7800.02
Support of additional rotators	R&S®FU129-ARS	3040.3416.02

R&S®MSD MODULAR SYSTEM DEVICE

Flexible antenna switching and rotator control



The R&S®MSD modular system device combines flexible antenna switching and positioning in one compact device.

In order to match project-specific requirements, various modules for antenna switching and/or positioning can be inserted into two rear slots of the 19" 2 HU rack-mountable case. The R&S®MSD can be operated with AC or DC power for maximum flexibility and easy integration into a mobile monitoring vehicle. Additional options, such as DC feeds and splitters, round off the functionality.

The R&S®MSD can be operated locally (via the touch-screen on the front panel) or remotely controlled (via a LAN/WAN connection).

Key facts

- ▶ Antenna switching and/or rotator control in one powerful device
- ▶ Frequency range from DC to 26.5 GHz
- ▶ Compact design (19", 2 HU)
- ▶ Variable power supply (AC or DC)



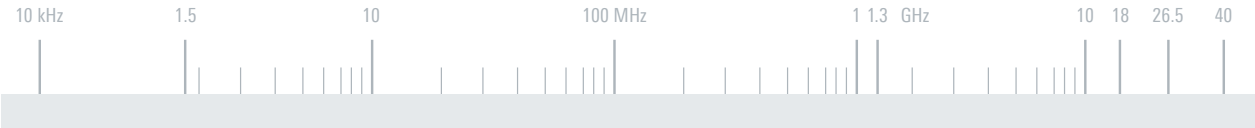

Specifications		
Front panel		5" touchscreen display, standby/on switch, 1 x USB2.0 interface
Modules		8 GHz RF switch module, 26.5 GHz RF switch module, rotator control basic axis #1 and #2, rotator control extension axis #3 and mast
Operating temperature range		0°C to +50°C
AC power supply		100 V to 240 V, 50 Hz to 60 Hz, max. 4 A
DC power supply		12 V to 30 V, max. 30 A
Dimensions (W x H x D)	without feet or handles	approx. 444.6 mm x 88.1 mm x 456.0 mm (18 in x 4 in x 18 in), 19", 2 HU
Weight		approx. 6 kg to 10 kg (13 lb to 22 lb), depends on configuration

Ordering information	Type	Order No.
Modular system device	R&S®MSD	3046.4008.02
Options		
Switch module 8, SP6T switch, DC to 8 GHz	R&S®MSD-SM8	3046.4508.02
Switch module 26, SP6T switch, DC to 26.5 GHz	R&S®MSD-SM26	3046.4608.02
SPDT switch, DC to 8 GHz ¹⁾	R&S®MSD-SW	3046.4714.02
Splitter, DC to 8 GHz ¹⁾	R&S®MSD-SP	3046.5104.02
DC feed, powers one external 9 kHz to 8 GHz antenna ¹⁾	R&S®MSD-DCF	3046.5004.02
Rotator control basic, controls 2 rotators/axes	R&S®MSD-RCB	3046.4808.02
Rotator control basic, controls 2 rotators/axes, for ProSisTel rotators	R&S®MSD-RCB-P	3059.1002.02
Rotator control extension, controls 1 rotator/axis plus one mast ²⁾	R&S®MSD-RCE	3046.4908.02
AC power supply	R&S®MSD-AC	3046.5204.02
DC power supply	R&S®MSD-DC	3046.5304.02

¹⁾ Requires R&S®MSD-SM8/26 option.
²⁾ Requires R&S®MSD-RCB option.

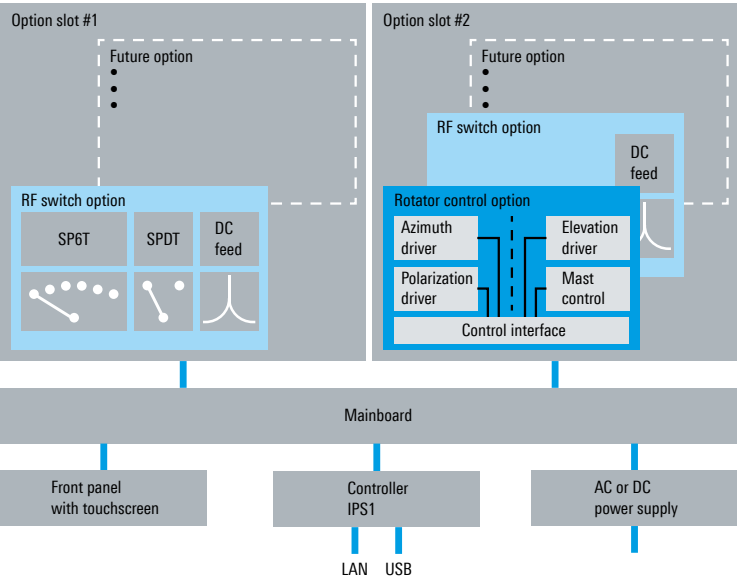

Main components

GLOSSARY

Term	Description
A	
Absorption	<ol style="list-style-type: none"> In the transmission of electrical, electromagnetic or acoustic signals, the conversion of the transmitted energy into another form, usually thermal. <ul style="list-style-type: none"> ▷ Absorption is one cause of signal attenuation. ▷ The conversion takes place as a result of interaction between the incident energy and the material medium, at the molecular or atomic level. (ATIS-0100523.2011) The irreversible conversion of energy of an electromagnetic wave into another form of energy as a result of its interaction with matter. (IEEE)
ANSI	American National Standards Institute The US standards organization that establishes procedures for the development and coordination of voluntary American National Standards. (ATIS-0100523.2011)
Antenna	<ol style="list-style-type: none"> Any structure or device used to collect or radiate electromagnetic waves. (ATIS-0100523.2011) A device that converts radio frequency electrical energy to radiated electromagnetic energy and vice versa. (ATIS-0100523.2011)
Antenna aperture	see "Aperture"
Antenna array	An assembly of antenna elements with dimensions, spacing and illumination sequence such that the fields for the individual elements combine to produce a maximum intensity in a particular direction and minimum field intensities in other directions. (ATIS-0100523.2011)
Antenna dissipative loss	A power loss resulting from changes in the measurable impedance of a practical antenna from a value theoretically calculated for a perfect antenna. (ATIS-0100523.2011)
Antenna effective area	see "Effective area"
Antenna efficiency	The ratio of the total radiated power to the total input power. ▷ The total radiated power is the total input power less antenna dissipative losses. (ATIS-0100523.2011)
Antenna factor	<p>The antenna factor K is the quotient of the electric field strength E and the voltage V present at 50 Ω (e.g. a matched receiver input).</p> $K = \frac{\text{Electric field strength}}{\text{Antenna output voltage at } 50\Omega}$ <ul style="list-style-type: none"> ▷ This factor includes the effects of antenna effective length or gain and mismatch and transmission line losses. ▷ The factor for electric field strength is not necessarily the same as the factor for magnetic field strength. (IEEE)
Antenna gain	<ol style="list-style-type: none"> The ratio of the power required at the input of a loss-free reference antenna to the power supplied to the input of the given antenna to produce, in a given direction, the same field strength at the same distance. <ul style="list-style-type: none"> ▷ Antenna gain is usually expressed in dB. ▷ Unless otherwise specified, the gain refers to the direction of maximum radiation. The gain may be considered for a specified polarization. Depending on the choice of the reference antenna, a distinction is made between: <ul style="list-style-type: none"> - absolute or isotropic gain (Gi) when the reference antenna is an isotropic antenna isolated in space; - gain relative to a half-wave dipole (Gd) when the reference antenna is a half-wave dipole isolated in space and with an equatorial plane that contains the given direction. (ATIS-0100523.2011) The ratio of the radiation intensity, in a given direction, to the radiation intensity that would be obtained if the power accepted by the antenna were radiated isotropically. <ul style="list-style-type: none"> ▷ Gain does not include losses arising from impedance and polarization mismatches. ▷ If an antenna is without dissipative loss, then, in any given direction, its gain is equal to its directivity. ▷ If the direction is not specified, the direction of the maximum radiation intensity is implied. (IEEE)
Antenna gain-to-noise temperature	see "G/T ratio"
Antenna lobe	see "Lobe"
Antenna noise temperature	<p>The temperature of a hypothetical resistor at the input of an ideal noise-free receiver that would generate the same output noise power per unit bandwidth as that at the antenna output at a specified frequency.</p> <ul style="list-style-type: none"> ▷ The antenna noise temperature depends on antenna coupling to all noise sources in its environment as well as on noise generated within the antenna. ▷ The antenna noise temperature is a measure of noise whose value is equal to the actual temperature of a passive device. (ATIS-0100523.2011)
Antenna tuning unit	see "ATU"
Aperture	In a directional antenna, the portion of a plane surface very near the antenna normal to the direction of maximum radiant intensity, through which the major part of the radiation passes. (ATIS-0100523.2011)

Term	Description
Atmospheric duct	<p>A horizontal layer in the lower atmosphere in which the vertical refractive index gradients are such that radio signals</p> <ul style="list-style-type: none"> ▶ are guided or focused within the duct ▶ tend to follow the curvature of the Earth ▶ experience less attenuation in the ducts than they would if the ducts were not present <p>▷ The reduced refractive index at the higher altitudes bends the signals back toward the Earth. Signals in a higher refractive index layer, i.e. duct, tend to remain in that layer because of the reflection and refraction encountered at the boundary with a lower refractive index material. (ATIS-0100523.2011)</p>
Attenuation	<ol style="list-style-type: none"> 1. The decrease in intensity of a signal, beam or wave as a result of absorption of energy and of scattering out of the path to the detector, but not including the reduction due to geometric spreading. (ATIS-0100523.2011) 2. A general term used to denote a decrease in signal magnitude in transmission from one point to another. Attenuation may be expressed as a scalar ratio of the input magnitude to the output magnitude or in decibels. (IEEE)
ATU	<p>Antenna tuning unit</p> <p>A device used to match the impedance of an antenna to the impedance of a transmitter or receiver to provide maximum power transfer.</p>
Azimuth	The angle between a horizontal reference direction (usually north) and the horizontal projection of the direction of interest, usually measured clockwise. (IEEE)
B	
Bandwidth	The difference between the limiting frequencies within which performance of a device, in respect to some characteristic, falls within specified limits. (ATIS-0100523.2011)
Band	The frequency spectrum between two defined limits. (ATIS-0100523.2011)
Beam	The main lobe of an antenna radiation pattern. (ATIS-0100523.2011)
Beamwidth	see "Half-power beamwidth"
Bias tee	A circuit that feeds a DC voltage to an RF path without affecting the RF parameters.
Boresight	The physical axis of a directional antenna. (ATIS-0100523.2011)
Boresight error	<ol style="list-style-type: none"> 1. The angular deviation of the electrical boresight of an antenna from its reference. (IEEE) 2. The deviation of the real main lobe direction to the theoretically available main lobe direction.
BW	see "Bandwidth"
C	
c	see "Speed of light"
Carrier	<ol style="list-style-type: none"> 1. In a frequency-stabilized system, the sinusoidal component of a modulated wave whose frequency is independent of the modulating wave; or the output of a transmitter when the modulating wave is made zero; or a wave generated at a point in the transmitting system and subsequently modulated by the signal; or a wave generated locally at the receiving terminal which when combined with the sidebands in a suitable detector, produces the modulating wave. (ATIS-0100523.2011) 2. The sinusoidal output signal of a transmitter at a typical frequency without any modulations.
Carrier power	The radio frequency power available at the antenna terminal when no modulating signal is present. (IEEE)
CCIR	International Radio Consultative Committee A predecessor organization of the ITU-R. (ATIS-0100523.2011)
CCITT	International Telegraph and Telephone Consultative Committee A predecessor organization of the ITU-T. (ATIS-0100523.2011)
CISPR	International Special Committee on Radio Interference A committee that defines EMC measurement standards.
Clockwise polarized wave	see "Right-hand polarized wave"
Compromising emanations	Unintentional signals that, if intercepted and analyzed, would disclose the information transmitted, received, handled, or otherwise processed by information systems equipment. (ATIS-0100523.2011)
Counterclockwise polarized wave	see "Left-hand polarized wave"
D	
dB	see "Decibel"
dBc	dB relative to the carrier power. (ATIS-0100523.2011)
dBd	<p>In the expression of antenna gain, the number of decibels of gain of an antenna referenced to the gain of a half-wave dipole.</p> <p>0 dBd \triangleq 2.15 dBi</p>
dBi	In the expression of antenna gain, the number of decibels of gain of an antenna referenced to the zero dB gain of a free-space isotropic radiator. (ATIS-0100523.2011)

Term	Description
Decibel	<p>1. One tenth of the common logarithm of the ratio of relative powers, equal to 0.1 B (bel). ▷ The decibel is the conventional relative power ratio, rather than the bel, for expressing relative powers because the decibel is smaller and therefore more convenient than the bel. The ratio in dB is given by</p> $dB = 10 \lg \left(\frac{P_1}{P_2} \right),$ <p>where P1 and P2 are the actual powers. Power ratios may be expressed in terms of voltage and impedance, E and Z, or current and impedance, I and Z, since</p> $P = I^2 \cdot Z = \frac{E^2}{Z}.$ <p>Thus, dB is also given by</p> $dB = 10 \lg \left(\frac{E_1^2/Z_1}{E_2^2/Z_2} \right) = 10 \lg \left(\frac{I_1^2 \cdot Z_1}{I_2^2 \cdot Z_2} \right)$ <p>If Z1 = Z2, these become</p> $dB = 20 \lg \left(\frac{E_1}{E_2} \right) = 20 \lg \left(\frac{I_1}{I_2} \right). \quad (\text{ATIS-0100523.2011})$
Decibel	<p>2. One tenth of a bel, the number of decibels denoting the ratio of the two amounts of power being ten times the logarithm to the base 10 of this ratio. ▷ The abbreviation dB is commonly used for the term decibel. With P1 and P2 designating two amounts of power and n the number of decibel denoting their ratio,</p> $n = 10 \lg \left(\frac{P_1}{P_2} \right) \text{ decibel.}$ <p>When the conditions are such that the ratios of currents or ratios of voltages (or analog quantities in other fields) are the square roots of the corresponding power ratios, the number of decibels by which the corresponding powers differ is expressed by the following equations:</p> $n = 20 \lg \left(\frac{I_1}{I_2} \right) \text{ decibel} \quad n = 20 \lg \left(\frac{U_1}{U_2} \right) \text{ decibel,}$ <p>where I1/I2 and U1/U2 are the given current and voltage ratios, respectively. By extension, these relations between numbers of decibels and ratios of currents or voltages are sometimes applied where these ratios are not the square roots of the corresponding power ratios; to avoid confusion, such usage should be accompanied by a specific statement of this application. Such extensions of the term described should preferably be avoided. (IEEE)</p>
Downconverter	<p>A device for performing frequency translation in such a manner that the output frequencies are lower in the spectrum than the input frequencies.</p>
E	
Effective area	<p>The functionally equivalent area from which an antenna directed toward the source of the received signal gathers or absorbs the energy of an incident electromagnetic wave. ▷ Antenna effective area is usually expressed in square meters. ▷ In the case of parabolic and horn-parabolic antennas, the antenna effective area is about 0.35 to 0.55 of the geometric area of the antenna aperture. (ATIS-0100523.2011)</p>
Effective aperture	<p>1. In a given direction, the ratio of the available power at the terminals of a receiving antenna to the power flux density of a plane wave incident on the antenna from that direction, the wave being polarization-matched to the antenna. ▷ If the direction is not specified, the direction of maximum radiation intensity is implied. (IEEE)</p> <p>2. A measure of the receive power which an antenna can take out of the total incoming power of a certain electromagnetic power density. The effective aperture is normally smaller than the geometrical aperture.</p>
Effective height	<p>1. The height of the center of radiation of an antenna above the effective ground level. (ATIS-0100523.2011)</p> <p>2. In low-frequency applications involving loaded¹⁾ or nonloaded vertical antennas, the moment of the current distribution in the vertical section divided by the input current. ▷ For an antenna with symmetrical current distribution, the center of radiation is the center of distribution. For an antenna with asymmetrical current distribution, the center of radiation is the center of current moments when viewed from points near the direction of maximum radiation. (ATIS-0100523.2011)</p> <p>¹⁾ Loaded antennas = electrically short antennas.</p>
Efficiency	<p>The ratio of the useful power output to the total power input. (IEEE) The ratio of the total radiated power to the total input power. ▷ The total radiated power is the total input power less antenna dissipative losses. (ATIS-0100523.2011)</p>

Glossary

Term	Description
EMS	<p>Electromagnetic susceptibility</p> <ol style="list-style-type: none"> 1. Of an electronic circuit or device, the degree to which it is subject to malfunction or failure under the influence of electromagnetic radiation. (ATIS-0100523.2011) 2. Electromagnetic susceptibility includes all function tests to prove that a technical device is not disturbed by any occurring incoming electromagnetic radiation equal to the defined maximum limit values.
EMI	<p>Electromagnetic interference</p> <ol style="list-style-type: none"> 1. Any electromagnetic disturbance that interrupts, obstructs or otherwise degrades or limits the effective performance of electronics/electrical equipment. It can be induced intentionally, as in some forms of electronic warfare, or unintentionally, as a result of spurious emissions and responses, intermodulation products and the like. (ATIS-0100523.2011) 2. An engineering term used to designate interference in a piece of electronic equipment caused by another piece of electronic or other equipment. EMI sometimes refers to interference caused by nuclear explosion. (ATIS-0100523.2011) 3. Electromagnetic interference includes all inspection measurements to prove that a technical device does not emit any electromagnetic radiation higher than the predefined limit values.
Emission	<p>Electromagnetic energy propagated from a source by radiation or conduction.</p> <p>▷ The emission may be either desired or undesired and may occur anywhere in the electromagnetic spectrum. (ATIS-0100523.2011)</p>
E plane	The plane containing the electric field vector and the direction of maximum radiation. (IEEE)
F	
Feed (element)	<ol style="list-style-type: none"> 1. For continuous aperture antennas, the primary radiator, for example, a horn feeding a reflector. (IEEE) 2. For array antennas, that portion of the antenna which functions to produce the excitation coefficients. (IEEE)
Far field	see "Far-field region"
Far-field region	<p>The region where the angular field distribution is essentially independent of the distance from the source.</p> <p>▷ If the source has a maximum overall dimension D that is large compared to the wavelength, the far-field region is commonly taken to exist at distances greater than $2D^2/\lambda$ from the source (λ being the wavelength).</p> <p>▷ For a beam focused at infinity, the far-field region is sometimes referred to as the Fraunhofer region. (ATIS-0100523.2011)</p>
Field	The volume of influence of a physical phenomenon, expressed vectorially. (ATIS-0100523.2011)
Field strength	<p>The magnitude of an electric, magnetic or electromagnetic field at a given point.</p> <p>▷ The field strength of an electromagnetic wave is usually expressed as the RMS value of the electric field, in volts per meter.</p> <p>The field strength of a magnetic field is usually expressed in amperes per meter.</p> <p>Synonym: radio field intensity. (ATIS-0100523.2011)</p>
Figure of merit	see "G/T ratio"
Flux	The rate of flow of energy through a surface. (IEEE)
Frequency	<ol style="list-style-type: none"> 1. For a periodic function, the number of cycles or events per unit time. 2. The number of cycles occurring per second of an electrical or electromagnetic wave; a number representing a specific point in the electromagnetic spectrum. (ATIS-0100523.2011)
Front-to-back ratio	<p>Of an antenna, the gain in a specified direction, i.e. azimuth, usually that of maximum gain, compared to the gain in a direction 180° from the specified azimuth.</p> <p>▷ Front-to-back ratio is usually expressed in dB. (ATIS-0100523.2011)</p>
G	
G/T ratio	<p>Gain-to-noise temperature, synonym: figure of merit</p> <p>In the characterization of antenna performance, a figure of merit, where G is the antenna gain in decibels at the receive frequency, and T is the equivalent noise temperature²⁾ of the receiving system in kelvin. (ATIS-0100523.2011)</p> <p>²⁾ Including antenna noise temperature.</p>
Gain	see "Antenna gain"
Graphical user interface	A computer environment or program that displays or facilitates the display of onscreen options, usually in the form of icons (pictorial symbols) or menus (lists of alphanumeric characters) by means of which users may enter commands. (ATIS-0100523.2011)

Term	Description
Ground wave	<p>1. In radio transmission, a surface wave that propagates close to the surface of the Earth. The Earth has one refractive index and the atmosphere has another, thus constituting an interface that supports surface wave transmission. These refractive indices are subject to spatial and temporal changes. Ground waves do not include ionospheric and tropospheric waves. (ATIS-0100523.2011)</p> <p>2. A radio wave that is propagated over the Earth and is ordinarily affected by the presence of the ground and troposphere. The ground wave is refracted because of variations in the dielectric constant of the troposphere, including the condition known as surface duct. (IEEE)</p>
GUI	see "Graphical user interface"
H	
Half-power beamwidth	<p>Of an antenna pattern, the angle between the half-power (3 dB) points of the main lobe, when referenced to the peak effective radiated power of the main lobe.</p> <p>▷ Beamwidth is usually expressed in degrees. (ATIS-0100523.2011)</p>
Hertz	<p>The SI unit of frequency, equal to one cycle per second.</p> <p>▷ A periodic phenomenon that has a period of one second has a frequency of one hertz. (ATIS-0100523.2011)</p>
H plane	The plane containing the magnetic field vector and the direction of maximum radiation.
HPBW	see "Half-power beamwidth"
Hz	see "Hertz"
I	
Impedance	<p>The total passive opposition offered to the flow of electric current.</p> <p>▷ Impedance is determined by the particular combination of resistance, inductive reactance and capacitive reactance in a given circuit.</p> <p>▷ Impedance is normally a function of frequency, except in the case of purely resistive networks. (ATIS-0100523.2011)</p>
Intercept point	<p>1. Intermodulation products have an output-versus-input characteristic which, when graphically displayed, would theoretically intercept the plot of the desired output-versus-input if the nonlinear device continued to operate linearly without compression. The signal input level at which this theoretical point would occur is called the intercept point and is usually defined in dBm (decibel referred to one milliwatt). The diagram below is a graphical representation of the intercept points for a single-tone second-order and a two-tone third-order intermodulation product. (IEEE)</p> <p>2. A point that is an extrapolated convergence – not directly measurable – of intermodulation distortion products in the desired output. That point indicates how well a receiver performs in the presence of strong nearby signals.</p> <p>▷ Determination of a third-order intercept point is accomplished by using two test frequencies that fall within the first intermediate frequency mixer passband. Usually, the test frequencies are about 20 kHz to 30 kHz apart. (ATIS-0100523.2011)</p>
Intermodulation	The production, in a nonlinear element of a system, of frequencies corresponding to the sum and difference frequencies of the fundamentals and harmonics thereof that are transmitted through the element. (ATIS-0100523.2011)

Intercept point

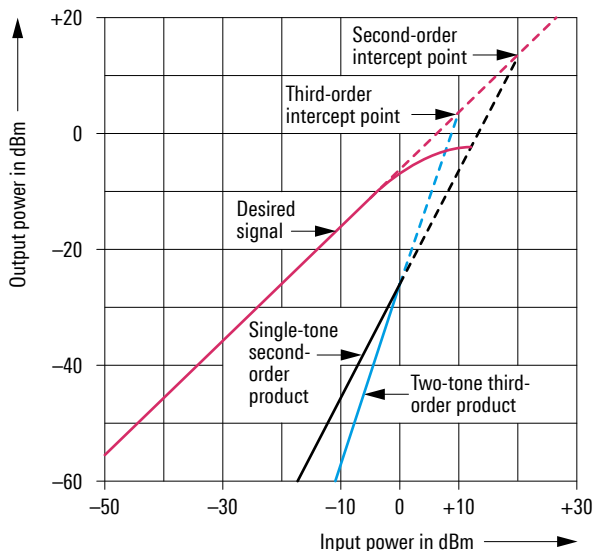

Glossary

Term	Description
Intermodulation product	In the output of a nonlinear system, a frequency produced by intermodulation of harmonics of the frequencies present in the input signal. (ATIS-0100523.2011)
Ionosphere	That part of the atmosphere, extending from about 70 km to 500 km, in which ions and free electrons exist in sufficient quantities to reflect and/or refract electromagnetic waves. (ATIS-0100523.2011)
Isotropic antenna	A hypothetical antenna that radiates or receives equally in all directions. ▷ Isotropic antennas do not exist physically but represent convenient reference antennas for expressing directional properties of physical antennas. (ATIS-0100523.2011)
Isotropic radiator	see "Isotropic antenna"
ITU	International Telecommunication Union A civil international organization established to promote standardized telecommunications on a world-wide basis. The ITU-R and ITU-T are committees under the ITU. The ITU headquarters is located in Geneva, Switzerland. While older than the United Nations, it is recognized by the UN as the specialized agency for telecommunications. (ATIS-0100523.2011)
ITU-R	International Telecommunication Union – Radiocommunications Sector Responsible for studying technical issues related to radiocommunications, and having some regulatory powers. ▷ A predecessor organization was the CCIR. (ATIS-0100523.2011)
ITU-T	International Telecommunication Union – Telecommunication Standardization Sector ▷ ITU-T is responsible for studying technical, operating and tariff questions and issuing recommendations on them, with the goal of standardizing telecommunications worldwide. ▷ In principle, the ITU-T combines the standards-setting activities of the predecessor organizations formerly called the International Telegraph and Telephone Consultative Committee (CCITT) and the International Radio Consultative Committee (CCIR). (ATIS-0100523.2011)
K	
K factor	see "Antenna factor"
L	
LAN	see "Local area network"
Left-hand polarized wave	An elliptically or circularly polarized wave, in which the electric field vector, observed in the fixed plane, normal to the direction of propagation, while looking in the direction of propagation, rotates with time in a left-hand or counterclockwise direction. ▷ Also called counterclockwise polarized wave. (ATIS-0100523.2011)
Lobe	1. A lobe is a portion of the directional pattern bounded by one or two cones of nulls. (IEEE) 2. A three-dimensional section of the radiation pattern of a directional antenna, bounded by one or more cones of nulls or by regions of diminished irradiance. (ATIS-0100523.2011)
Local area network	A data communications system that (a) lies within a limited spatial area, (b) has a specific user group, (c) has a specific topology, and (d) is not a public switched telecommunications network, but maybe connected to one. (ATIS-0100523.2011)
Loss	1. The diminution, usually expressed in dB, of signal level in a communications medium. (ATIS-0100523.2011) 2. The power, usually expressed in watts, consumed or dissipated by a circuit or component without accomplishing useful work or purpose; e.g. heating (hysteresis loss) that occurs in the core of a transformer. (ATIS-0100523.2011) 3. The attenuation of a signal level in a communications medium (usually expressed in dB).
M	
Main beam	see "Main lobe" Also called major lobe.
Main lobe	Of an antenna radiation pattern, the lobe containing the maximum power (exhibiting the greatest field strength). ▷ The width of the main lobe is usually specified as the angle encompassed between the points where the power has fallen 3 dB below the maximum value. (ATIS-0100523.2011)
Matched	Matched means that the impedance of e.g. an antenna is equal to the impedance of the RF cable and to the impedance of the connected device (e.g. transmitter or receiver). No reflections degrade the power transmission. A matched system offers the highest efficiency.
Mean power	The average power supplied to the antenna transmission line by a transmitter during an interval of time sufficiently long compared with the lowest frequency encountered in the modulation taken under normal operating conditions. ▷ Normally, a time of 0.1 second, during which the mean power is greatest, will be selected. (ATIS-0100523.2011)
Medium	In telecommunications, the transmission path along which a signal propagates, such as a wire pair, coaxial cable, waveguide, optical fiber or radio path. (ATIS-0100523.2011)

Term	Description
Modulation	The process, or result of the process, of varying a characteristic parameter of a carrier in accordance with an information-bearing signal. (ATIS-0100523.2011)
MTBF	Mean time between failures An indicator of expected system reliability calculated on a statistical basis from the known failure rates of various components of the system. MTBF is usually expressed in hours. (ATIS-0100523.2011)
MTTR	Mean time to repair The time interval (hours) that may be expected to return a failed equipment to proper operation. (IEEE)
N	
Near-field region	The close-in region of an antenna wherein the angular field distribution is dependent upon the distance from the antenna. (ATIS-0100523.2011)
Near zone	see "Near-field region"
NF	see "Noise figure"
Noise	An undesired disturbance within the frequency band of interest; the summation of unwanted or disturbing energy introduced into a communications system from man-made and natural sources. (ATIS-0100523.2011)
Noise factor	see "Noise figure"
Noise figure	<p>1. Of an active device, over the bandwidth of interest, the contribution by the device itself to thermal noise at its output. The noise figure is usually expressed in decibels (dB), and is, with respect to thermal noise power at the system impedance, at a standard noise temperature (usually +20°C, 293 K) over the bandwidth of interest. It is determined by</p> <p>(a) measuring (determining) the ratio, usually expressed in dB, of the thermal noise power at the output, to that at the input, and</p> <p>(b) subtracting from that result, the gain, in dB, of the system. Typical noise figures range from 0.5 dB for very low noise devices, to 4 dB to 8 dB. In some systems, e.g. heterodyne systems, total output noise power includes noise from other than thermal sources, such as spurious contributions from image-frequency transformation, but noise from these sources is not considered in determining the noise figure. In this example, the noise figure is determined only with respect to that noise that appears in the output via the principal frequency transformation of the system and excludes noise that appears via the image frequency transformation. (ATIS-0100523.2011)</p> <p>2. At a selected input frequency, the ratio of (A) the total noise power per unit bandwidth (at a corresponding output frequency) delivered by the system into an output termination to (B) the portion thereof engendered at the input frequency by the input termination, whose noise temperature is standard (290 K at all frequencies). (IEEE)</p>
Noise temperature	<p>At a pair of terminals, the temperature of a passive system having an available noise power per unit bandwidth at a specified frequency equal to that of the actual terminals of a network.</p> <p>▷ The noise temperature of a simple resistor is the actual temperature of that resistor. The noise temperature of a diode may be many times the actual temperature of the diode. (ATIS-0100523.2011)</p> <p>▷ Noise temperature of an antenna depends on its coupling to all noise sources in its environment as well as noise generated within the antenna. (IEEE)</p>
NVIS	Near vertical incidence skywave In radio propagation, a wave that is reflected from the ionosphere at a nearly vertical angle and that is used in short-range communications to reduce the area of the skip zone and thereby improve reception beyond the limits of the ground wave. (ATIS-0100523.2011)
O	
Omnidirectional antenna	An antenna that has a radiation pattern that is nondirectional in azimuth. ▷ The vertical radiation pattern may be of any shape. (ATIS-0100523.2011)
P	
Peak envelope power	see "PEP"
PEP	Peak envelope power The average power supplied to the antenna transmission line by a transmitter during one radio frequency cycle at the crest of the modulation envelope taken under normal operating conditions. (ATIS-0100523.2011)
Phantom feeding	A DC supply voltage is fed into an RF cable via a bias tee circuit.
Polarization	<p>Of an electromagnetic wave, the property that describes the orientation, i.e. time-varying direction and amplitude, of the electric field vector.</p> <p>▷ States of polarization are described in terms of the figures traced as a function of time by the projection of the extremity of a representation of the electric vector onto a fixed plane in space, which plane is perpendicular to the direction of propagation. In general, the figure, i.e. polarization, is elliptical and is traced in a clockwise or counterclockwise sense, as viewed in the direction of propagation. If the major and minor axes of the ellipse are equal, the polarization is said to be circular. If the minor axis of the ellipse is zero, the polarization is said to be linear. Rotation of the electric vector in a clockwise sense is designated right-hand polarization, and rotation in a counterclockwise sense is designated left-hand polarization. (ATIS-0100523.2011)</p>

Glossary

Term	Description
Polarization decoupling	The attenuation between a signal with a certain polarization and a signal with the same frequency but a differing polarization, e.g. cross-polarization decoupling.
Polarization diversity	Diversity transmission and reception wherein the same information signal is transmitted and received simultaneously on orthogonally polarized waves with fade-independent propagation characteristics. (ATIS-0100523.2011)
Power	The rate of transfer or absorption of energy per unit time in a system. (ATIS-0100523.2011)
Propagation	The motion of waves through or along a medium. ▷ For electromagnetic waves, propagation may occur in a vacuum as well as in material media. (ATIS-0100523.2011)
Propagation channel	The physical medium in which electromagnetic wave propagation takes place. This channel includes everything that influences the propagation between two antennas.
Propagation path	see "Propagation channel"
R	
Radar cross section	An expression on the extent to which an object, i.e. a target reflects radar pulses, usually with respect to their point of origin. The radar cross section of an aircraft can vary by a factor of over 100, depending on the aspect angle of the aircraft to the radar transmitter. (ATIS-0100523.2011)
Radiant power	The rate of flow of electromagnetic energy, i.e. radiant energy. ▷ Radiant power is usually expressed in watts, i.e. joules per second. (ATIS-0100523.2011)
Radiation	In radiocommunications, the emission of energy in the form of electromagnetic waves. The outward flow of energy from any source in the form of radio waves. (ATIS-0100523.2011)
Radiation pattern	The variation of the field intensity of an antenna as an angular function with respect to the antenna axis. ▷ A radiation pattern is usually represented graphically for the far-field conditions in either the horizontal or vertical plane. (ATIS-0100523.2011)
Radio frequency	see "RF"
Radio path	In the medium air, the channel or path through which the propagation between two antennas takes place.
RCS	see "Radar cross section"
Reciprocity	For antennas, the possibility that the same antenna can be used either for receiving and for transmitting. ▷ One exception to this rule are active antennas – which can generally be used for receiving only.
Reference antenna	An antenna that may be real, virtual, or theoretical, and has a radiation pattern that can be used as a basis of comparison with other antenna radiation patterns. ▷ Examples of reference antennas are unit dipoles, half-wave dipoles and isotropic, i.e. omnidirectional, antennas. (ATIS-0100523.2011)
RF	Of, or pertaining to, any frequency within the electromagnetic spectrum normally associated with radio wave propagation. ▷ For designation of subdivisions, see "Electromagnetic spectrum" and the associated diagram. (ATIS-0100523.2011)
Right-hand polarized wave	An elliptically or circularly polarized wave, in which the electric field vector, observed in any fixed plane, normal to the direction of propagation, while looking in the direction of propagation, rotates with time in a right-hand or clockwise direction. Synonym: clockwise polarized wave. (ATIS-0100523.2011)
Rotary joint	A device transmitting cable-bound RF signals via a mechanically rotating joint to a device that is rotated. Slip rings at a rotary joint are used for feeding e.g. control signals through the mechanically rotating joint. They are not meant for RF signals.
S	
Side lobe	In a directional antenna radiation pattern, a lobe in any direction other than that of the main lobe. (ATIS-0100523.2011)
Side lobe suppression	1. Any process, action or adjustment taken to reduce the level of the side lobes or to reduce the degradation of the intended antenna system performance resulting from the presence of side lobes. (IEEE) 2. Also the value of the side lobe suppression.
Silent tuning	A feature of some ATUs. ▷ After a first learning tuning cycle, the ATU stores its frequency-dependent setting values in a built-in memory. The now available silent tuning mode can set the ATU to the stored values without initiating a new tuning process that would involve the transmission of a signal.
Silent zone	see "Skip zone"
Skip zone	An annular region within the transmission range of an antenna, within which signals from the transmitter are not received. The skip zone is bounded by the locus of the farthest points at which the ground wave can be received and the nearest points at which reflected skywaves can be received. Synonyms: silent zone, zone of silence. (ATIS-0100523.2011)
Skywave	A radio wave that travels upward from the antenna. ▷ A skywave may be reflected to Earth by the ionosphere. (ATIS-0100523.2011)

Term	Description
Speed of light (c)	<p>The speed of an electromagnetic wave in free space, precisely 299,792,458 m/s.</p> <p>▷ The speed of an electromagnetic wave, e.g. light, is equal to the product of wavelength and frequency.</p> $c = \lambda \cdot f$ <p>▷ In any physical medium, the velocity of propagation of light is lower than the speed of light in free space. Since the frequency is not changed, in any physical medium, the wavelength is also decreased. (ATIS-0100523.2011)</p>
Spillover	In a (reflector) antenna, the part of the radiated energy from the feed that does not impinge on the reflectors. (ATIS-0100523.2011)
Surface duct	An atmospheric duct for which the lower boundary is the surface bounding the atmosphere. (IEEE)
T	
TEMPEST	<p>Telecommunications Electronics Material Protected from Emitting Spurious Transmissions</p> <p>1. Short name referring to investigation, study and control of compromising emanations from information systems (IS) equipment. (ATIS-0100523.2011)</p> <p>2. To shield against compromising emanation. (ATIS-0100523.2011)</p>
Troposphere	<p>1. The lower layers of atmosphere, in which the change of temperature with height is relatively large. It is the region where clouds form, convection is active, and mixing is continuous and more or less complete.</p> <p>2. The layer of the Earth's atmosphere, between the surface and the stratosphere, in which temperature decreases with altitude and which contains approximately 80% of the total air mass. Note: The thickness of the troposphere varies with season and latitude. It is usually 16 km to 18 km thick over tropical regions, and less than 10 km thick over the poles. (ATIS-0100523.2011)</p>
V	
Voltage standing wave ratio	see "VSWR"
VSWR	<p>Voltage standing wave ratio</p> <p>In a transmission line, the ratio of maximum to minimum voltage in a standing wave pattern.</p> <p>▷ The VSWR is a measure of impedance mismatch between the transmission line and its load. The higher the VSWR, the greater the mismatch. The minimum VSWR, i.e. that which corresponds to a perfect impedance match, is unity. (ATIS-0100523.2011)</p>
W	
Wavelength	<p>The distance between points of corresponding phase of two consecutive cycles of a wave.</p> <p>▷ The wavelength, λ, is related to the propagation velocity, v, and the frequency, f, by $\lambda = v/f$. (ATIS-0100523.2011)</p> <p>▷ In air, the propagation velocity, v, is equal to c, the speed of light.</p>
Z	
Zone of silence	see "Skip zone"

INDEX

Type	Designation	Page	
A			
	R&S®AC004R1/R&S®AC004L1	Omnidirectional antennas	162
	R&S®AC004R2/R&S®AC004L2	Omnidirectional antennas	164
	R&S®AC005 New	Omnidirectional antenna	130
	R&S®AC008	Microwave directional antenna	138
	R&S®AC308R2	SHF directional antenna	140
	R&S®AC308R3	SHF/EHF directional antenna	142
	R&S®AC025DP	Dual-polarized reflector antenna	144
	R&S®AD016MC	Compact broadband TX antenna	168
	R&S®AD033V3	Omnidirectional UHF antenna	104
	R&S®AD066FW	Broadband VHF/UHF communications antenna system	106
	R&S®AD066ST	Omnidirectional UHF antenna	108
	R&S®AK503	Mobile HF antenna	36
	R&S®AM524 Update	Low-noise active antenna system	62
	R&S®AU600	Active omnidirectional receiving antenna system	128
C			
	R&S®CP001	Antenna remote control software (ARCOS)	192
F			
	R&S®FK002H0 New	Antenna tuning unit (1 kW)	46
	R&S®FT224	VHF/UHF diplexer	180
	R&S®FU129	Antenna filter unit	196
G			
	R&S®GB016	Control unit	182
	R&S®GB130	Control unit	188
	R&S®GX002 New	Junction unit	176
H			
	R&S®HA104/512	HF whip antenna	32
	R&S®HA230/403	HF receiving antenna	34
	R&S®HE010D	Active HF dipole	26
	R&S®HE010E	Active rod antenna	28
	R&S®HE016	Active antenna system	30
	R&S®HE202 Update	Active receiving dipole	74
	R&S®HE314A1	Active omnidirectional antenna	76
	R&S®HE302 Update	Active receiving dipole	72
	R&S®HE309E	Active vertical dipole	70
	R&S®HE400 Update	Handheld directional antenna	78
	R&S®HE400BC New	Basic handheld directional antenna	84
	R&S®HE400DC New	Handheld directional antenna with downconverter (antenna handle)	80
	R&S®HE400MW New	Microwave handheld directional antenna	82
	R&S®HE500	Active receiving antenna	86
	R&S®HE600	Active omnidirectional receiving antenna	88
	R&S®HE800-PA New	Handheld directional antenna with preamplifier	132
	R&S®HF214	Omnidirectional antenna	64
	R&S®HF902	Omnidirectional antenna	66
	R&S®HF907	Double-ridged waveguide horn antenna	170
	R&S®HF907DC	SHF directional antenna with downconverter	134
	R&S®HF907OM	Broadband omnidirectional antenna	166

Type	Designation	Page
R&S®HF918	High-gain SHF antenna	172
R&S®HFH2-Z2E	Active loop antenna	56
R&S®HFH2-Z6E	Active rod antenna	58
R&S®HK001E	UHF coaxial dipole	110
R&S®HK012E	VHF coaxial dipole	112
R&S®HK014E	VHF/UHF coaxial dipole	114
R&S®HK033	VHF/UHF coaxial dipole	116
R&S®HK055L1	Broadband mobile antenna	120
R&S®HK055S1	Omnidirectional broadband antenna	118
R&S®HK056	Broadband mobile antenna	122
R&S®HK060	Broadband manpack antenna	124
R&S®HK061	Vehicular broadband communications antenna	126
R&S®HK116E	Biconical antenna	90
R&S®HK309	Passive receiving dipole	68
R&S®HL007A2	Crossed log-periodic antenna	92
R&S®HL024A1	Crossed log-periodic antennas	146
R&S®HL024S2	Crossed log-periodic antenna	148
R&S®HL024S7	Crossed log-periodic antenna	150
R&S®HL024S8	Crossed log-periodic antenna	152
R&S®HL024S9	Crossed log-periodic antenna	154
R&S®HL033	Log-periodic broadband antenna	94
R&S®HL040E	Log-periodic broadband antenna	96
R&S®HL047	New High gain log-periodic antenna	98
R&S®HL050	Log-periodic antennas	156
R&S®HL050E	Log-periodic antenna	160
R&S®HL050S7	Log-periodic directional antenna with preamplifier	158
R&S®HL210A3	Log-periodic HF antenna	52
R&S®HL223	Log-periodic antenna	100
R&S®HL410A3	Log-periodic HF antenna	54
R&S®HL451	Log-periodic HF antenna	48
R&S®HL471	Log-periodic HF antenna	50
R&S®HL562E	ULTRALOG	102
R&S®HM020E	Triple-loop antenna	24
R&S®HX002H0	New HF dipole with ATU	38
R&S®HX002H1	150 W HF dipole	40
R&S®HX002H2	150 W HF dipole	42
R&S®HX002H3/R&S®HX002H3M	New HF dipole with ATU	44
I		
R&S®IN600	Bias unit	178
M		
R&S®MSD	Modular system device	198
O		
R&S®OCB600	Outdoor control for R&S®AU600	194
R&S®OSP-BS016	New Antenna control module	180
R		
R&S®RD016	Antenna rotator	186
R&S®RD130	Antenna rotator	190



Архангельск (8182)63-90-72
Астана (7172)727-132
Астрахань (8512)99-46-04
Барнаул (3852)73-04-60
Белгород (4722)40-23-64
Брянск (4832)59-03-52
Владивосток (423)249-28-31
Волгоград (844)278-03-48
Вологда (8172)26-41-59
Воронеж (473)204-51-73
Екатеринбург (343)384-55-89
Иваново (4932)77-34-06

Ижевск (3412)26-03-58
Иркутск (395)279-98-46
Казань (843)206-01-48
Калининград (4012)72-03-81
Калуга (4842)92-23-67
Кемерово (3842)65-04-62
Киров (8332)68-02-04
Краснодар (861)203-40-90
Красноярск (391)204-63-61
Курск (4712)77-13-04
Липецк (4742)52-20-81

Магнитогорск (3519)55-03-13
Москва (495)268-04-70
Мурманск (8152)59-64-93
Набережные Челны (8552)20-53-41
Нижний Новгород (831)429-08-12
Новокузнецк (3843)20-46-81
Новосибирск (383)227-86-73
Омск (3812)21-46-40
Орел (4862)44-53-42
Оренбург (3532)37-68-04
Пенза (8412)22-31-16

Пермь (342)205-81-47
Ростов-на-Дону (863)308-18-15
Рязань (4912)46-61-64
Самара (846)206-03-16
Санкт-Петербург (812)309-46-40
Саратов (845)249-38-78
Севастополь (8692)22-31-93
Симферополь (3652)67-13-56
Смоленск (4812)29-41-54
Сочи (862)225-72-31
Ставрополь (8652)20-65-13

Сургут (3462)77-98-35
Тверь (4822)63-31-35
Томск (3822)98-41-53
Тула (4872)74-02-29
Тюмень (3452)66-21-18
Ульяновск (8422)24-23-59
Уфа (347)229-48-12
Хабаровск (4212)92-98-04
Челябинск (351)202-03-61
Череповец (8202)49-02-64
Ярославль (4852)69-52-93

Киргизия (996)312-96-26-47

Россия (495)268-04-70

Казахстан (772)734-952-31

<https://rohdeschwarz.nt-rt.ru> || rwz@nt-rt.ru