

Цифровые мультиметры 7352A/E



Архангельск (8182)63-90-72
Астана (7172)727-132
Астрахань (8512)99-46-04
Барнаул (3852)73-04-60
Белгород (4722)40-23-64
Брянск (4832)59-03-52
Владивосток (423)249-28-31
Волгоград (844)278-03-48
Вологда (8172)26-41-59
Воронеж (473)204-51-73
Екатеринбург (343)384-55-89
Иваново (4932)77-34-06

Ижевск (3412)26-03-58
Иркутск (395)279-98-46
Казань (843)206-01-48
Калининград (4012)72-03-81
Калуга (4842)92-23-67
Кемерово (3842)65-04-62
Киров (8332)68-02-04
Краснодар (861)203-40-90
Красноярск (391)204-63-61
Курск (4712)77-13-04
Липецк (4742)52-20-81

Киргизия (996)312-96-26-47

Магнитогорск (3519)55-03-13
Москва (495)268-04-70
Мурманск (8152)59-64-93
Набережные Челны (8552)20-53-41
Нижний Новгород (831)429-08-12
Новокузнецк (3843)20-46-81
Новосибирск (383)227-86-73
Омск (3812)21-46-40
Орел (4862)44-53-42
Оренбург (3532)37-68-04
Пенза (8412)22-31-16

Россия (495)268-04-70

Пермь (342)205-81-47
Ростов-на-Дону (863)308-18-15
Рязань (4912)46-61-64
Самара (846)206-03-16
Санкт-Петербург (812)309-46-40
Саратов (845)249-38-78
Севастополь (8692)22-31-93
Симферополь (3652)67-13-56
Смоленск (4812)29-41-54
Сочи (862)225-72-31
Ставрополь (8652)20-65-13

Казахстан (772)734-952-31

Сургут (3462)77-98-35
Тверь (4822)63-31-35
Томск (3822)98-41-53
Тула (4872)74-02-29
Тюмень (3452)66-21-18
Ульяновск (8422)24-23-59
Уфа (347)229-48-12
Хабаровск (4212)92-98-04
Челябинск (351)202-03-61
Череповец (8202)49-02-64
Ярославль (4852)69-52-93

Evolution from Dual to TWIN



Open up a new age of digital multimeters by real two-channel synchronous measurement

A new concept digital multimeter 7352 series has appeared, offering various applications and improved throughput.

The 7352A/7352E is the next-generation digital multimeter having twin-A/D converters that enable fully-independent measurement of two-channel signals, and is suitable for high-speed measurement, parallel measurement of different functions and multi-channel measurement by configuring a system.

The channel A (Ach) has basic measurement functions for DC voltage/current, AC voltage/current, resistance and frequency, while the channel B (Bch) has DC voltage/current, AC current and temperature measurement

functions. Thus, higher throughput can be obtained with Ach/Bch synchronous measurement or Ach/Bch parallel measurement of different functions.

Furthermore, the dynamic range of current measurement has been broadened significantly, enabling measurement from low current of 10pA to high current of 10A.

The 7352A is equipped with an RS-232 interface in addition to USB and GPIB interfaces for use in R&D and production lines. The 7352E is equipped with a USB interface for low-cost system configuration.

The remote command language not only complies with the conventional ADC commands and SCPI, but also is compatible with that of the digital multimeter R6452A.



7352A/E

Hi Ach Lo

Hi Bch Lo

A/D converter Photo coupler

A/D converter Photo coupler

LOGIC CPU

- Synchronous measurement by twin A/D converters
- Completely isolated between the channels

Conventional dual DMM

Hi Ach Lo 5MΩ

Hi Bch Lo

A/D converter Photo coupler

LOGIC CPU

- Measures Ach and Bch alternately with a single A/D converter.
- The impedance between Ach and Bch is only 5MΩ because Bch is a differential input circuit. The potential difference between the channels due to a differential resistance error causes a large error in Bch measurement. (0.05%)

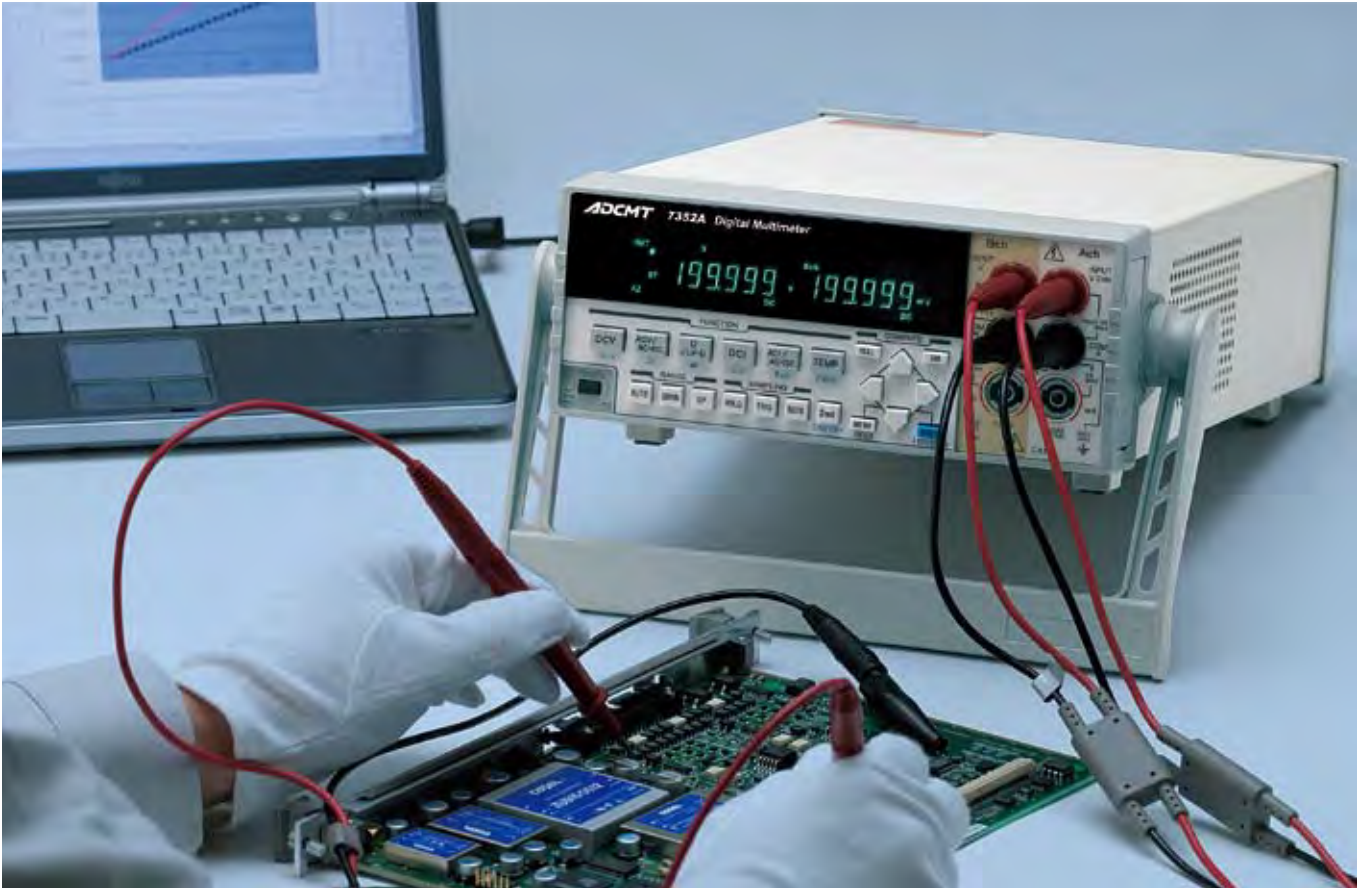

Various Solutions to Meet Your Needs!

Synchronization

Improve the system throughput with minimum dispersion?

Twin A/D converters realize synchronous measurement of Ach and Bch functions.

Even at the sampling rate per PLC at which noise rejection is possible, two-function measurement data can be obtained without switching the functions, allowing the significant improvement of the system throughput.

High accuracy

Measure Bch as well as Ach highly accurately?

Since Bch is fully independent from Ach, its measurement is not affected by the potential difference between them. In addition, high-accuracy Bch measurement is available with 5½-digit display.

Moreover, this series is capable of high-accuracy parallel measurement of different measurement functions such as voltage/current, voltage or current/temperature, or AC/DC between Ach and Bch.

Low current

Measure much lower current?

The broadened dynamic range enables measurement of low power consumption. Ach has measurement ranges from 2 μ A (10pA resolution) to 2A, and Bch has 10A measurement range (100 μ A resolution). Two functions such as current/voltage or current/temperature can be measured with high sensitivity and resolution and these results are dual-displayed.

System configuration

Build up a system easily?

In building up a system, system interfaces are available for easy connection with a programmable controller. The 7352A is equipped with USB, GPIB and RS-232 interfaces as standard.

Evaluation of DC/DC Converter

The input and output characteristics, load regulation characteristics, conversion efficiency, and rise in temperature of a DC/DC converter can be evaluated by a single unit of the 7352A/7352E.

This series has five measurement capabilities: input voltage/current on Ach, output voltage/current on Bch and temperature on rear TEMP. In addition, change in input current or temperature against load current fluctuation can be measured in real time by using two-channel parallel measurement.

Thanks to complete isolation between the channels, the input and output of an isolated DC/DC converter can be measured by just one unit. The channel outputs of a multi-output converter can be also monitored simultaneously by using one unit per two channels. Even in such case, there is no crosstalk between the channels.

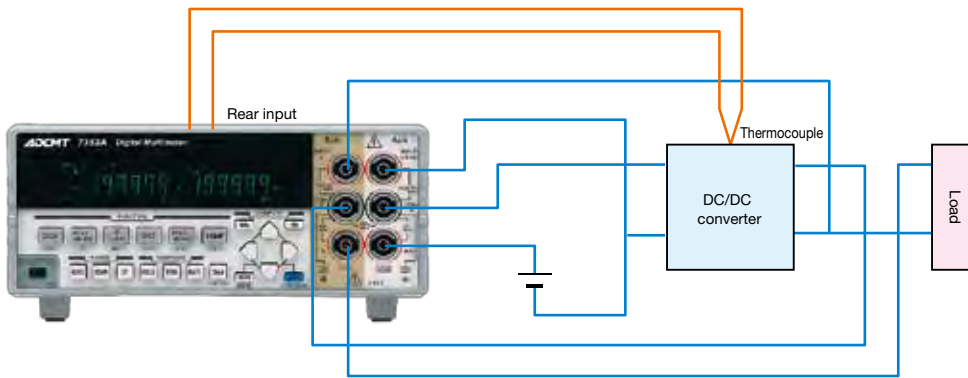
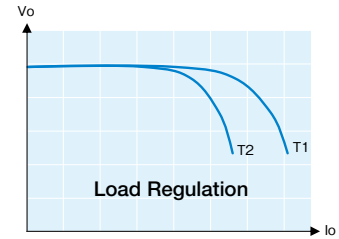
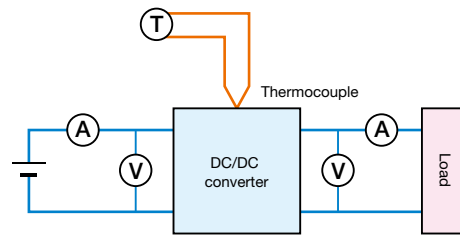

Testing of Power Unit

The conventional dual DMM has the following problems in testing a power unit.

- Switching measurement is required because of a single A/D converter.
- It takes time to switch the AC-DC functions.
- When there is a potential difference between Ach LO and Bch LO, a large measurement error occurs on Bch.

Thus, in such measurement, two digital multimeters are required. On the other hand, the 7352A/7352E is provided with completely isolated Ach, Bch and TEMP, and is equipped with two independent A/D converters. Thus, switching measurement

and functional change are unnecessary, and high-throughput measurement is available without influence between the channels. It has six measurement capabilities: AC input voltage/current and frequency on Ach, DC output voltage/current on Bch, and temperature on rear TEMP.

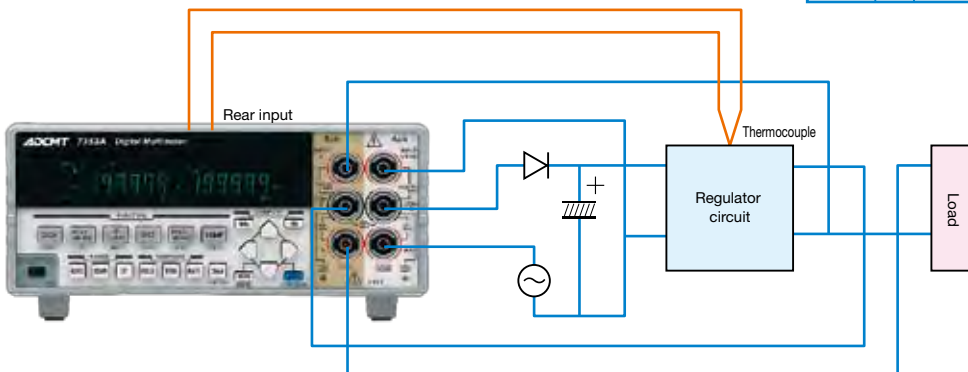
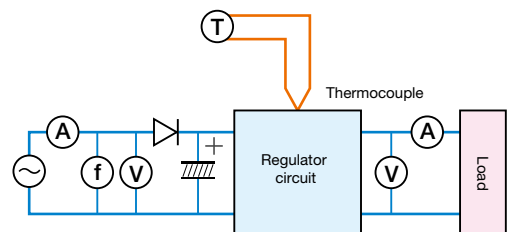

Right and Left Display Combinations and Measurement Functions

Left side display			Right side display														
			Measurement function	Measurement Range	OFF	Ach								Bch			
						DCV	ACV ACV (AC+DC)	Ω LP- Ω	DCI	ACI ACI (AC+DC)	Continuity	Diode	FREQ	DCV	DCI	ACI ACI (AC+DC)	TEMP
Ach	DCV	1 μ V-1000V	Single measurement	Sequential measurement (Two functions are alternately measured by switching them.)								Synchronous measurement					
	ACV	True RMS															
	ACV (AC+DC)	1 μ V-700V															
	Ω	1m Ω -200M Ω															
	LP- Ω																
	DCI	10pA-2A															
	ACI	True RMS															
	ACI (AC+DC)	1nA-2A															
	Continuity	-															
Bch	Diode	-	Single measurement	Synchronous measurement (Two functions are simultaneously measured.)								Sequential measurement					
	FREQ	10Hz-300kHz															
	DCV	1 μ V-200V															
	DCI	100 μ A-10A															
	ACI	True RMS															
ACI (AC+DC)	100 μ A-10A																
TEMP	K, T thermocouple																

Measurement Time

The maximum sampling rate is 140 readings/sec for 1-channel single measurement and 123 readings/sec for 2-channel synchronous measurement. The sampling rate per PLC at which noise rejection is possible is 46 readings/sec for single measurement and 40 readings/sec for synchronous measurement that are the highest rate in this class.

RATE mode	Integration time	Display digit	Single measurement			Synchronous measurement	
			DCV DCI 2W Ω LP-2W Ω	ACV ACI continuity diode	ACV (AC+DC) ACI (AC+DC)	DCV DCI 2W Ω LP-2W Ω	ACV ACI continuity diode
FAST	2ms	19999	140 rdgs/s (7.1ms)		30 rdgs/s (33ms)	123 rdgs/s (8.1ms)	
MED (50Hz)	1PLC	199999	40 rdgs/s (25ms)		19 rdgs/s (52ms)	38 rdgs/s (26.3ms)	
MED (60Hz)	1PLC	199999	46 rdgs/s (21.7ms)		22 rdgs/s (45.4ms)	43.5 rdgs/s (23ms)	
SLOW1	100ms	199999	9.5 rdgs/s (105ms)		4.7 rdgs/s (212ms)	9.5 rdgs/s (105ms)	
SLOW2	200ms	199999	4.9 rdgs/s (205ms)		2.4 rdgs/s (412ms)	4.9 rdgs/s (205ms)	

Conditions: Auto-range: OFF, Auto-zero: OFF, Calculation: OFF, Display: OFF

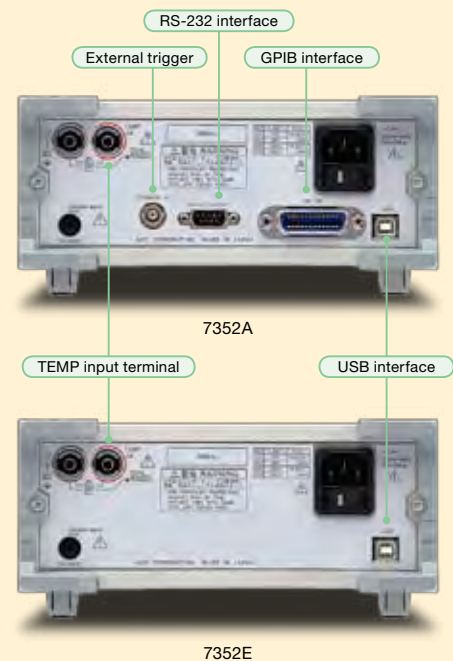

Specifications

Unless otherwise specified, the measurement accuracy is guaranteed for one year under the following conditions: Temperature; 23 ±5°C, relative humidity; 85% or less (75% or less in resistance measurement of 20MΩ or more and low power resistance measurement of 2MΩ or more). Temperature coefficient: For the 4½-digit display, the digit error is reduced to 1/10.

Channel A (ACh)

■ DC Voltage Measurement (DCV-Ach)

Range	Maximum display		Resolution		Input impedance	Measurement accuracy ^{*1} ± (% of reading + digits)			Temperature coefficient ± (ppm of reading + digits)/°C	
	FAST	MED/SLOW1,2	FAST	MED/SLOW1,2		FAST	MED	SLOW1,2	Auto-zero ON	Auto-zero OFF
200mV	199.99	199.999	10μV	1μV	More than 1GΩ	0.012+4	0.012+6	0.012+6	15+0.85	15+2
2000mV	1999.9	1999.99	100μV	10μV	More than 1GΩ	0.011+2	0.011+2	0.011+2	15+0.2	15+1.5
20V	19.999	19.9999	1mV	100μV	10MΩ±1%	0.015+2	0.015+4	0.015+4	20+0.25	20+1.5
200V	199.99	199.999	10mV	1mV	10MΩ±1%	0.015+2	0.015+4	0.015+4	20+0.25	20+1.5
1000V	1099.9	1099.99	100mV	10mV	10MΩ±1%	0.015+2	0.015+4	0.015+4	20+0.25	20+1.5

*1 For Auto-zero ON. For Auto-zero OFF, 1 digit is added to the digit error.

■ Noise rejection ratio

Effective common mode noise rejection ratio (Unbalanced impedance of 1kΩ)	DC	FAST	MED/SLOW1,2
		Approx. 130dB	Approx. 130dB
Normal mode noise rejection ratio	50/60Hz±0.08%	Approx. 60dB	Approx. 120dB
	50/60Hz±0.08%	0dB	Approx. 60dB

■ Maximum input

Between VΩHz and COM A terminals	1000Vpeak
----------------------------------	-----------

■ AC Voltage Measurement (ACV, ACV (AC+DC)-Ach)

Measurement method: True RMS measurement, RMS display

Input range: 5% or more of a full scale

Crest Factor: 3 : 1 at a full scale (This is restricted to the maximum input.)

Temperature coefficient: (1/10 of measurement accuracy that includes the additional error)/°C in each range and frequency range

Response time: Approx. 1s (Time until the measurement value reaches within 0.1% of the final value in the same range)

ACV

Range	Maximum display		Resolution		Input impedance	Measurement accuracy ^{*2} ± (% of reading + digits)				
	FAST/MED	SLOW1,2	FAST/MED	SLOW1,2		20-45Hz	45-100Hz	100-20kHz	20k-50kHz	50k-100kHz
200mV	199.99	199.999	10μV	1μV	1MΩ±2%, 140pF or less	0.38+140	0.11+120	0.1+100	0.25+150	0.7+240
2000mV	1999.9	1999.99	100μV	10μV		0.38+140	0.11+120	0.1+100	0.2+150	0.6+240
20V	19.999	19.9999	1mV	100μV		0.38+140	0.11+120	0.1+100	0.2+150	0.6+240
200V	199.99	199.999	10mV	1mV		0.38+140	0.11+120	0.1+100	0.2+150	0.6+240
700V	749.9	749.99	100mV	10mV		0.38+100	0.11+100	0.1+100	-	-
						0.38+100	0.11+100	0.1+100	-	-

*2 For a sine-wave input. When RATE is set to FAST or MED, the digit error is reduced to 1/10 of its specification.

ACV (AC+DC)

Range	Maximum display		Resolution		Input impedance	Measurement accuracy ^{*2} ± (% of reading + digits)				
	FAST/MED	SLOW1,2	FAST/MED	SLOW1,2		20-45Hz	45-100Hz	100-20kHz	20k-50kHz	50k-100kHz
200mV	199.9	199.99	100μV	10μV	1MΩ±2%, 140pF or less	0.38+14	0.11+14	0.1+14	0.25+15	0.7+24
2000mV	1999	1999.9	1000μV	100μV		0.38+14	0.11+14	0.1+14	0.2+15	0.6+24
20V	19.99	19.999	10mV	1000μV		0.38+14	0.11+14	0.1+14	0.2+15	0.6+24
200V	199.9	199.99	100mV	10mV		0.38+14	0.11+14	0.1+14	0.2+15	0.6+24
700V	749	749.9	1000mV	100mV		0.38+10	0.11+10	0.1+10	-	-
						0.38+10	0.11+10	0.1+10	-	-

*2 For a sine-wave input. When RATE is set to FAST or MED, the digit error is reduced to 1/10 of its specification.

Additional crest factor error (For a non sine-wave input voltage) ±(% of reading + % of range)

1-2	0+0.05
2-3	0+0.15

Maximum input

Between VΩHz and COM A terminals	700Vrms, 1000Vpeak, 2.2×10 ⁷ V Hz
----------------------------------	--

Additional error to the ACV (AC+DC) measurement ±(% of reading)

	FAST	MED
20-45Hz	1.24%	0.72%
45-100Hz	0.06%	-

■ Resistance Measurement (2WΩ, LP-2WΩ-Ach)

2WΩ measurement

Range	Maximum display		Resolution		Measurement current	Measurement accuracy ^{*3} ± (% of reading + digits)			Temperature coefficient ± (ppm of reading+digits)/°C	
	FAST	MED/SLOW1,2	FAST	MED/SLOW1,2		FAST	MED	SLOW1,2	Auto-zero ON	Auto-zero OFF
200Ω	199.99	199.999	10mΩ	1mΩ	1mA	0.02+4	0.02+9	0.02+8	20+1	20+2
2000Ω	1999.9	1999.99	100mΩ	10mΩ	1mA	0.02+2	0.02+5	0.014+3	15+0.25	15+1.5
20kΩ	19.999	19.9999	1Ω	100mΩ	100μA	0.02+2	0.02+5	0.014+3	15+0.25	15+1.5
200kΩ	199.99	199.999	10Ω	1Ω	10μA	0.02+2	0.02+5	0.02+5	20+0.25	20+1.5
2000kΩ	1999.9	1999.99	100Ω	10Ω	1μA	0.03+2	0.03+10	0.03+10	35+2	35+5
20MΩ	19.999	19.9999	1kΩ	100Ω	100nA	0.2+2	0.2+10	0.2+10	155+2	155+5
200MΩ	199.99	199.999	10kΩ	1kΩ	10nA	1.5+2	1.5+10	1.5+10	1500+2	1500+5

Low power measurement (LP-2WΩ)

Range	Maximum display		Resolution		Measurement current	Measurement accuracy ^{*3} ± (% of reading + digits)			Temperature coefficient ± (ppm of reading+digits)/°C	
	FAST	MED/SLOW1,2	FAST	MED/SLOW1,2		FAST	MED	SLOW1,2	Auto-zero ON	Auto-zero OFF
200Ω	199.99	199.999	10mΩ	1mΩ	1mA	0.02+4	0.02+9	0.02+8	20+1	20+5
2000Ω	1999.9	1999.99	100mΩ	10mΩ	100μA	0.03+4	0.03+9	0.03+8	20+1	20+3
20kΩ	19.999	19.9999	1Ω	100mΩ	10μA	0.03+4	0.03+9	0.03+8	20+1	20+3
200kΩ	199.99	199.999	10Ω	1Ω	1μA	0.03+4	0.03+9	0.03+8	30+1	30+3
2000kΩ	1999.9	1999.99	100Ω	10Ω	100nA	0.2+2	0.2+12	0.2+12	150+2	150+5
20MΩ	19.999	19.9999	1kΩ	100Ω	10nA	1.5+5	1.5+50	1.5+50	1500+2	1500+5

*3 For Auto-zero ON. For Auto-zero OFF, 2 digits are added to the digit error. In addition, the offset error, which consists of the input cable resistance and 0.2Ω, is added.

Response time	200MΩ = 2s (Time until the measurement value reaches within 0.1% of the final value)
	20MΩ = 0.5s (Time until the measurement value reaches within 0.1% of the final value)

Open-circuit voltage	7.5V or less
----------------------	--------------

Maximum input

Between VΩHz and COM A terminals	1000Vpeak
----------------------------------	-----------

■ DC Current Measurement (DCI-Ach)

Range	Maximum display		Resolution		Resistance between terminals (A fuse resistance is included.)	Measurement accuracy ¹⁴ ±(% of reading + digits)			Temperature coefficient ±(ppm of reading+digits)/°C	
	FAST	MED/SLOW1,2	FAST	MED/SLOW1,2		FAST	MED	SLOW1,2	Auto-zero ON	Auto-zero OFF
2000nA	1999.9	1999.99	100pA	10pA	11.5kΩ or less	0.15+35	0.15+40	0.15+40	150+4	150+4
20μA	19.999	19.9999	1nA	100pA		0.1+7	0.1+7	0.1+5	100+1	100+1.6
200μA	199.99	199.999	10nA	1nA	102Ω or less	0.04+20	0.04+40	0.04+40	40+4	40+5
2000μA	1999.9	1999.99	100nA	10nA		0.04+2	0.04+7	0.04+5	40+1	40+1.6
20mA	19.999	19.9999	1μA	100nA	2Ω or less	0.04+20	0.04+40	0.04+40	40+4	40+5
200mA	199.99	199.999	10μA	1μA		0.05+2	0.05+7	0.05+6	50+0.6	50+3
2000mA	1999.9	1999.99	100μA	10μA	0.6Ω or less	0.15+2	0.15+7	0.15+6	150+0.6	150+3

¹⁴ For Auto-zero ON. For Auto-zero OFF, 2 digits are added to the digit error.

Maximum input	Input protection	Fuse replacement
2A	2A/250V fast-blow fuse which is compliant with IEC60127 sheet1	On the rear panel

■ AC Current Measurement (ACI, ACI (AC+DC)-Ach)

Measurement method: True RMS measurement, RMS display
 Input range: 5% or more of a full scale
 Crest Factor: 3 : 1 at a full scale

Temperature coefficient: (1/10 of measurement accuracy that includes the additional error)/°C in each range and frequency range
 Response time: Approx. 1s (Time until the measurement value reaches within 0.1% of the final value in the same range)

ACI

Range	Maximum display		Resolution		Resistance between terminals (A fuse resistance is included.)	Measurement accuracy ² ±(% of reading + digits)		
	FAST/MED	SLOW1,2	FAST/MED	SLOW1,2		20-45Hz	45-1kHz	1k-5kHz
200μA	199.99	199.999	10nA	1nA	102Ω or less	0.4+200	0.3+200	0.3+100
2000μA	1999.9	1999.99	100nA	10nA		0.5+200	0.35+100	0.35+200
20mA	19.999	19.9999	1μA	100nA	2Ω or less	0.4+200	0.3+200	0.3+100
200mA	199.99	199.999	10μA	1μA		0.4+200	0.3+200	0.3+100
2000mA	1999.9	1999.99	100μA	10μA	0.6Ω or less	0.5+200	0.35+100	0.7+200

² For sine-wave input. When RATE is set to FAST or MED, the digit error is reduced to 1/10 of its specification.

ACI (AC+DC)

Range	Maximum display		Resolution		Resistance between terminals (A fuse resistance is included.)	Measurement accuracy ² ±(% of reading + digits)		
	FAST/MED	SLOW1,2	FAST/MED	SLOW1,2		20-45Hz	45-1kHz	1k-5kHz
200μA	199.9	199.99	100nA	10nA	102Ω or less	0.4+20	0.3+20	0.3+10
2000μA	1999	1999.9	1μA	100nA		0.5+20	0.35+10	0.35+20
20mA	19.99	19.999	10μA	1μA	2Ω or less	0.4+20	0.3+20	0.3+10
200mA	199.9	199.99	100μA	10μA		0.4+20	0.3+20	0.3+10
2000mA	1999	1999.9	1mA	100μA	0.6Ω or less	0.5+20	0.35+10	0.7+20

² For sine-wave input. When RATE is set to FAST or MED, the digit error is reduced to 1/10 of its specification.

Additional crest factor error (For a non sine-wave) ±(% of reading + % of range)

Range	Crest factor	
	1-2	2-3
200μA-20mA	0+0.05	0+0.15
200mA, 2000mA	0+0.05	0.1+0.15

Maximum input	Input protection	Fuse replacement
2A	2A/250V fast-blow fuse which is compliant with IEC60127 sheet 1	On the rear panel

Additional error to the ACI (AC+DC) measurement ±(% of reading)

	FAST	MED
20-45Hz	1.24%	0.72%
45-1kHz	0.06%	-

■ Frequency Measurement (FREQ-Ach)

Measurement method: Reciprocal

Measurement frequency range	Measurement accuracy
10Hz to 300kHz	0.02% of reading

A frequency over the above range is displayed but not guaranteed.

Input signal condition: For sine-wave

Input signal voltage range: 100mVrms to 700Vrms and 10% of each voltage range or more (However, the input signal is restricted to the maximum input.)

Gate time

Sampling rate	Gate time	Measurement frequency range	Maximum measurement period	Maximum display
SLOW	1000ms	1Hz to 300kHz	2.2s	999999
MED	100ms	10Hz to 300kHz	220ms	99999
FAST	10ms	100Hz to 300kHz	22ms	9999

Maximum input

Between VΩHz and COM A terminals	700Vrms, 1000Vpeak, 2.2×10 ⁷ Hz
----------------------------------	--

■ Diode Measurement-Ach

Range	Maximum display		Resolution		Measurement current	Measurement accuracy ¹⁵ ±(% of reading + digits)			Temperature coefficient ±(ppm of reading+digits)/°C	
	FAST	MED/SLOW1,2	FAST	MED/SLOW1,2		FAST	MED	SLOW1,2	Auto-zero ON	Auto-zero OFF
2000mV	1999.9	1999.99	100μV	10μV	1mA	0.014+2	0.014+5	0.014+3	15+0.25	15+1.5

¹⁵ For Auto-zero ON. For Auto-zero OFF, 2 digits are added to the digit error. In addition, an offset error, which is obtained by multiplying (the resistance of the input cable + 0.3Ω) by 1mA, is added.

Other specifications are the same as the resistance measurement function.

Continuity Measurement-Ach

Range	Maximum display		Resolution		Measurement current	Measurement accuracy *4 ±(% of reading + digits)			Temperature coefficient ±(ppm of reading+digits)/°C	
	FAST	MED/SLOW1,2	FAST	MED/SLOW1,2		FAST	MED	SLOW1,2	Auto-zero ON	Auto-zero OFF
2000Ω	1999.9	1999.99	100mΩ	10mΩ	1mA	0.014+2	0.014+5	0.014+3	15+0.25	15+1.5

*4 For Auto-zero ON. For Auto-zero OFF, 2 digits are added to the digit error.

Continuity judgment value: 1Ω to 1000Ω

Other specifications are the same as the resistance measurement function.

Channel B (Bch)

DC Voltage Measurement (DCV-Bch)

Range	Maximum display		Resolution		Input impedance	Measurement accuracy *1 ±(% of reading + digits)			Temperature coefficient ±(ppm of reading+digits)/°C	
	FAST	MED/SLOW1,2	FAST	MED/SLOW1,2		FAST	MED	SLOW1,2	Auto-zero ON	Auto-zero OFF
200mV	199.99	199.999	10μV	1μV	More than 1GΩ	0.012+4	0.012+7	0.012+6	15+0.85	15+2
2000mV	1999.9	1999.99	100μV	10μV	More than 1GΩ	0.011+2	0.011+5	0.011+2	15+0.2	15+1.5
20V	19.999	19.9999	1mV	100μV	10MΩ±1%	0.015+2	0.015+5	0.015+5	20+0.25	20+1.5
200V	199.99	199.999	10mV	1mV	10MΩ±1%	0.015+2	0.015+5	0.015+5	20+0.25	20+1.5

*1 For Auto-zero ON. For Auto-zero OFF, 1 digit is added to the digit error.

Noise rejection ratio

	DC	FAST	MED/SLOW1,2
Effective common mode noise rejection ratio (Unbalanced impedance of 1kΩ)	50/60Hz±0.08%	Approx. 130dB	Approx. 130dB
Normal mode noise rejection ratio	50/60Hz±0.08%	0dB	Approx. 60dB

Maximum input

Between V and COM B terminals	200Vpeak
-------------------------------	----------

DC Current Measurement (DCI-Bch)

Range	Maximum display		Resolution		Resistance between terminals (A fuse resistance is included.)	Measurement accuracy *4 ±(% of reading + digits)			Temperature coefficient ±(ppm of reading+digits)/°C	
	FAST	MED/SLOW1,2	FAST	MED/SLOW1,2		FAST	MED	SLOW1,2	Auto-zero ON	Auto-zero OFF
10A	11.999	11.9999	1mA	100μA	0.03Ω or less	0.2+2	0.2+7	0.2+5	200+0.6	200+3

*4 For Auto-zero ON. For Auto-zero OFF, 2 digits are added to the digit error.

Maximum input	Input protection	Fuse replacement
10A	15A/250V fast-blow fuse with 10000A breaking capacity	Contact ADC Corporation to repair

AC Current Measurement (ACI, ACI (AC+DC)-Bch)

Measurement method: True RMS measurement, RMS display

Input range: 5% or more of a full scale

Crest Factor: 3 : 1 at a full scale

Temperature coefficient: (1/10 of measurement accuracy that includes the additional error)/°C in each range and frequency range

Response time: Approx. 1s (Time until the measurement value reaches within 0.1% of the final value in the same range)

ACI

Range	Maximum display		Resolution		Resistance between terminals (A fuse resistance is included.)	Measurement accuracy *2 ±(% of reading + digits)		
	FAST/MED	SLOW1,2	FAST/MED	SLOW1,2		20-45Hz	45-1kHz	1k-5kHz
10A	11.999	11.9999	1mA	100μA	0.03Ω or less	0.5+200	0.5+200	0.7+200

*2 For sine-wave input. When RATE is set to FAST or MED, the digit error is reduced to 1/10 of its specification.

ACI (AC+DC)

Range	Maximum display		Resolution		Resistance between terminals (A fuse resistance is included.)	Measurement accuracy *2 ±(% of reading + digits)		
	FAST/MED	SLOW1,2	FAST/MED	SLOW1,2		20-45Hz	45-1kHz	1k-5kHz
10A	11.99	11.999	10mA	1mA	0.03Ω or less	0.5+20	0.5+20	0.7+20

*2 For sine-wave input. When RATE is set to FAST or MED, the digit error is reduced to 1/10 of its specification.

Additional crest factor error (For a non sine-wave) ±(% of reading + % of range)

Range	Crest factor	
	1-2	2-3
10A	0+0.05	0.07+0.15

Additional error to the ACI (AC+DC) measurement ±(% of reading)

	FAST	MED
20-45Hz	1.24%	0.72%
45-1kHz	0.06%	-

Temperature Measurement (TEMP-Bch)

		Thermocouple	
		K (CA)	T (CC)
Input terminal	Range	-50°C to 1370°C	-50°C to 400°C
TEMP HI - LO	Maximum display	1370.0	400.0
	Resolution	0.1°C	0.1°C
	Measurement accuracy	±0.15%±3°C	±0.15%±3°C

Maximum input

Between TEMP (HI) and TEMP (LO) terminals	36Vpeak
---	---------

Compliant thermocouple standard: JIS C1602

Cold junction compensation: Internal

■ Maximum Input

Between COM A and COM B terminals	200V
Between TEMP (HI/LO) and COM A terminals	200Vpeak
Between TEMP (HI/LO) and COM B terminals	200Vpeak
Between COM terminal and the chassis	500V
Between TEMP (HI/LO) and the chassis	500V

Calculation Functions

NULL calculation:

Display value (NULL) = Measurement value - NULL constant

Smoothing calculation:

Display value (SM) = Moving average over a specified number of measurements

Comparator calculation:

Display (HIGH) ← HIGH setting value < Measurement value

Display (LOW) ← Measurement value < LOW setting value

Display (GO) ← LOW setting value ≤ Measurement value ≤ HIGH setting value

Scaling calculation:

Display (SCL) = (Measurement value - B) / A × C
A, B and C are constants. (Setting value)

MAX and MIN calculation:

Display value (MAX) = Maximum measurement value after the calculation starts

Display value (MIN) = Minimum measurement value after the calculation starts

Display value (AVE) = Arithmetic mean after the calculation starts (Remote output only)

dB and dBm calculation:

db display = 20 log (Measurement value / D)

dBm display = 10 log [(Measurement value)² / D] / 10⁻³

D is constant. (Setting value)

Statistical calculation:

Number of samples

Display value (SAMPLE) = Number of measurement values in the specified range of the measurement memory

Maximum value

Display value (MAX) = Maximum measurement value in the specified range of the measurement memory

Minimum value

Display value (MIN) = Minimum measurement value in the specified range of the measurement memory

Average value

Display value (AVE) = Average value in the specified range of the measurement memory

Standard deviation

Display value (SIGMA) = Standard deviation in the specified range of the measurement memory

Dispersion

Display value (P-P) = ((Maximum measurement value) - (Minimum measurement value)) in the specified range of the measurement memory

Calculation between 2 measurements:

Display value (M1+M2) = Left side display: M1 + Right side display: M2

Display value (M1-M2) = Left side display: M1 - Right side display: M2

Display value (M1*M2) = Left side display: M1 × Right side display: M2

Display value (M1/M2) = Left side display: M1 / Right side display: M2

External trigger signal (7352A)

Connector: BNC

Signal level: TTL, detecting the falling edge

Pulse width: 1μs or more

General Specifications

Operating environment: Ambient temperature: 0°C to 50°C
However, 0 to +45°C in cases where 1A or more and 5A or more are simultaneously applied to Ach and Bch respectively for the current measurement.

Relative humidity: 85% or less, no condensation

Storage environment: Ambient temperature: -25°C to 70°C

Warm-up time: 60 minutes or more

Display: Dual 6-digit and 7-segment vacuum fluorescent display

Range switching: Automatic and manual

Input method: Floating

Measurement method: Integration

Overload display: OL

Power supply: AC power supply: 100V/120V/220V/240V

(Cab be switched by user)

Option Number	Standard	OPT.32	OPT.42	OPT.44
Power supply voltage	100V	120V	220V	240V

Specify the option when ordering.

Use a power cable and a fuse that are compliant with the safety standard when changing the power supply voltage.

Power supply frequency: 50Hz/60Hz

Power consumption: 22VA or below

Dimensions: Approx. 212 (W) x 88 (H) x 340 (D) mm

Mass: 3.7kg or less

Safety: IEC61010-1, EN61010-1

Measurement category II

EMC: EN61326 class A

Supplied Accessories

Name	Model	Quantity
Power cable	A01402	1
Input cable (red, black)	CC010001	1 each
Power fuse (for 100V/120V)	DFT-AAR315A-1	1 ⁶
Power fuse (for 220V/240V)	DFT-AAR25A-1	
Overcurrent protection fuse	DFS-AN2A-1	1
Operation manual	E7352A/E	1

⁶: Either one is included according to the specified option.

Optional Accessories

Name	Model	Remarks
Input cable	CC010001	Standard accessory
	A01001	Shielded cable 33VAC and 70VDC or less
Alligator clip adapter	CC015001	33VAC and 70VDC or less
RS-232 cable	A01265	
Terminal adapter	1111	
JIS rack-mount set	A02263	
	A02264	Twins
EIA rack-mount set	A02463	
	A02464	Twins
Panel-mount set	A02039	
	A02040	Twins
Sheath type thermocouple	1101-100	T (CC) type
	1101-130	K (CA) type

• Please read through the operation manual carefully before using the products.

• All specifications are subject to change without notice.

Архангельск (8182)63-90-72

Астана (7172)727-132

Астрахань (8512)99-46-04

Барнаул (3852)73-04-60

Белгород (4722)40-23-64

Брянск (4832)59-03-52

Владивосток (423)249-28-31

Волгоград (844)278-03-48

Вологда (8172)26-41-59

Воронеж (473)204-51-73

Екатеринбург (343)384-55-89

Иваново (4932)77-34-06

Ижевск (3412)26-03-58

Иркутск (395)279-98-46

Казань (843)206-01-48

Калининград (4012)72-03-81

Калуга (4842)92-23-67

Кемерово (3842)65-04-62

Киров (8332)68-02-04

Краснодар (861)203-40-90

Красноярск (391)204-63-61

Курск (4712)77-13-04

Липецк (4742)52-20-81

Киргизия (996)312-96-26-47

Магнитогорск (3519)55-03-13

Москва (495)268-04-70

Мурманск (8152)59-64-93

Набережные Челны (8552)20-53-41

Нижний Новгород (831)429-08-12

Новокузнецк (3843)20-46-81

Новосибирск (383)227-86-73

Омск (3812)21-46-40

Орел (4862)44-53-42

Оренбург (3532)37-68-04

Пенза (8412)22-31-16

Россия (495)268-04-70

Пермь (342)205-81-47

Ростов-на-Дону (863)308-18-15

Рязань (4912)46-61-64

Самара (846)206-03-16

Санкт-Петербург (812)309-46-40

Саратов (845)249-38-78

Севастополь (8692)22-31-93

Симферополь (3652)67-13-56

Смоленск (4812)29-41-54

Сочи (862)225-72-31

Ставрополь (8652)20-65-13

Казахстан (772)734-952-31

Сургут (3462)77-98-35

Тверь (4822)63-31-35

Томск (3822)98-41-53

Тула (4872)74-02-29

Тюмень (3452)66-21-18

Ульяновск (8422)24-23-59

Уфа (347)229-48-12

Хабаровск (4212)92-98-04

Челябинск (351)202-03-61

Череповец (8202)49-02-64

Ярославль (4852)69-52-93